

CINCON ELECTRONICS

# AC-DC SWITCHING POWER SUPPLY CATALOG 2019



Every day, 365 days a year Cincon makes a difference in people's lives throughout the world.

Design engineers and other power supply specifiers select our AC-DC and DC-DC convertors to power a wide range of products. Cincon power supplies are found in a myriad of applications, from medical equipment used to keep us healthy, to security systems working to keep us safe. Name an electronic device in any equipment category and it's likely you'll find a Cincon power supply inside. The communications, test instrumentation, entertainment, lighting, medical, computer, networking, industrial and transportation industries all use Cincon power supplies.

Cincon gives power supply specifiers what they need, speed and specification. Need a power supply fast? Designers can select from one of our 25,000 plus standard model numbers, many available off the shelf from distributors located around the globe. Give us a little more time and we can modify one of our standard products to your requirement. Need a full custom power supply? We do that also.

Using state of the art design tools, our power supplies are engineered with proven technology in one of our two Taiwan design laboratories. We focus heavily on reliability

in the early stages of development to ensure a robust final product. Combined with extensive verification testing at the prototype and pilot production stages, Cincon is able to offer power supplies with long operational lives.

Cincon AC-DC and DC-DC power supplies are manufactured in one of our wholly owned, ISO 9001 and ISO 14001 certified, manufacturing facilities in Taiwan and China. Products are built using the latest manufacturing and quality assurance techniques on state of the art equipment; giving our customers not only high quality but also short lead times.

As a global designer and manufacturer of AC-DC and DC-DC power supplies, our products are certified to international safety, efficiency, hazardous substance and EMI standards where required. We also have capability to design and certify to application and country specific standards.

When you require an AC-DC or DC-DC power supply, standard or custom, and have little time, look to us for a solution. Let Cincon power your idea.

# CONTENTS

NRND	CFM05S	5W	2	NEW	TRE15	15W	50
NEW	CFM06S	6W	4	NEW	TRE15R	15W	52
	CFM10,CFM15	10W,15W	6	NEW	TRE15RD	15W	54
NEW	CFM12S	12W	8		TRG15	15W	56
	CFM20	20W	10		TR15RA	15W	58
NRND	CFM21S	20W	12	NRND	TRH21A	20W	60
NEW	CFM25S	25W	14	NEW	TRE25	25W	62
	CFM40S,CFM60S	40W,60W	16	NEW	TRE25R	25W	64
NEW	CFM41S	40W	18	NEW	TRE25RD	25W	66
NEW	CFM61S	60W	20		TRH25	25W	68
	CFM40D,CFM40T	40W	22		TRG30RV	30W	70
	CFM60T	60W	24		TRG30RAV	30W	72
	CFM80S	80W	26	NEW	TRE36A	36W	74
NEW	CFM81S	80W	28		TRG36A	36W	76
NRND	CFM101S	100W	30		TRH50A	50W	78
NEW	CFM150S	150W	32		TRH70A	70W	80
NRND	CFM201S	200W	34	NRND	TRG70E	70W	82
NEW	CFM260S	260W	36		TRH100A	100W	84
	CFM300S	300W	38		TRH150A	150W	86
NRND	CFM361S	360W	40				
	CFM40C,CFM60C,CFM101C	40W,60W,100W	42		AC POWER CORD		88
	CBM100S	100W	44		CABLE & DC PLUG		90
NEW	TRE06S	6W	46				
	TRG10R	10W	48		REQUEST FOR QUOTE		92

# CFM05S SERIES

## 5 WATT

### Features

- ◆ Universal Input Range 85-264VAC
- ◆ Efficiency to 79%
- ◆ Meets EN55022 Class B
- ◆ Continuous Short Circuit Protection
- ◆ Low Leakage Current 0.25mA Max.
- ◆ PCB Mountable



### Mechanical Dimensions

All Dimensions in Inches (mm)  
 Tolerance Inches: X.XXX±0.02  
 Millimeters: X.X±0.5

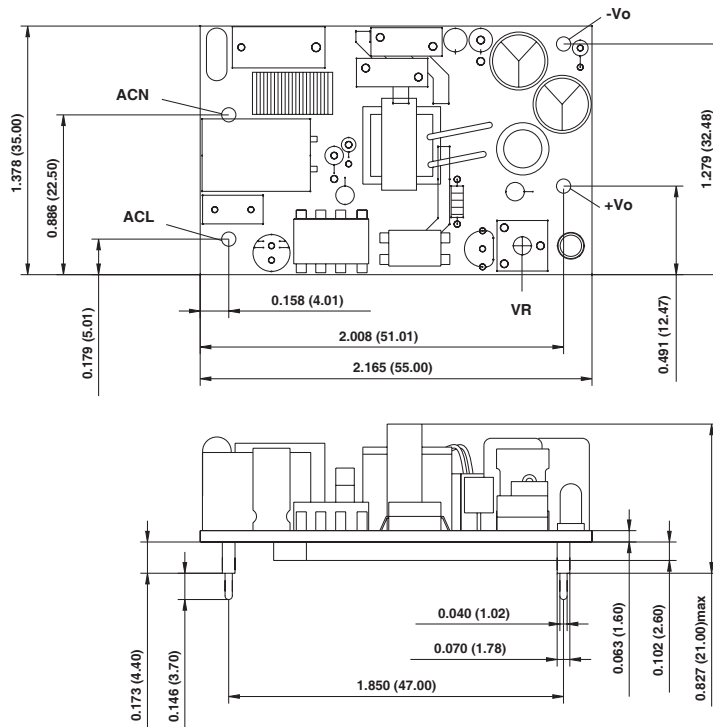

MODEL NUMBER	OUTPUT VOLTAGE	OUTPUT CURRENT		RIPPLE & (mVp-p) (NOTE 1)	VOLTAGE ACCURACY (NOTE 2)	LINE REGULATION (NOTE 3)	LOAD REGULATION (NOTE 4)	% EFF (Typ.) (NOTE 5)
		MIN.	MAX.					
CFM05S033	3.3 V	0 A	1.25 A	50 mV	±1%	±0.5%	±1%	69%
CFM05S050	5 V	0 A	1.0 A	50 mV	±1%	±0.5%	±1%	73%
CFM05S090	9 V	0 A	0.55 A	90 mV	±1%	±0.5%	±1%	77%
CFM05S120	12 V	0 A	0.42 A	120 mV	±1%	±0.5%	±1%	77%
CFM05S150	15 V	0 A	0.33 A	150 mV	±1%	±0.5%	±1%	78%
CFM05S180	18 V	0 A	0.28 A	180 mV	±1%	±0.5%	±1%	79%
CFM05S240	24 V	0 A	0.23 A	240 mV	±1%	±0.5%	±1%	76%

## Derating Curve

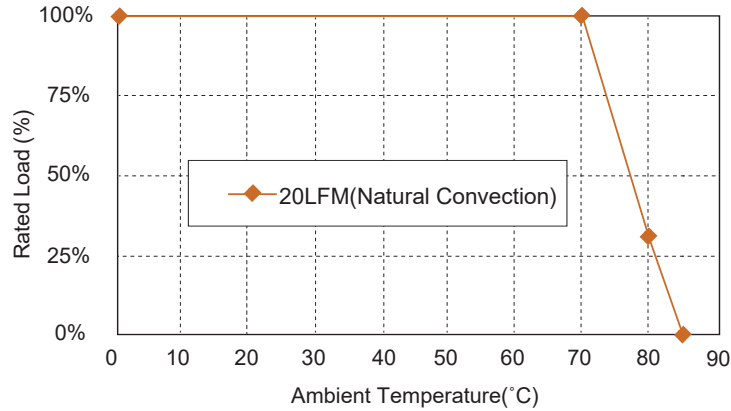

## Specifications

All Specifications Typical At Nominal Line, 75% Load and 25°C Unless Otherwise Noted

### INPUT SPECIFICATIONS

Voltage	85-264Vac, 120-370Vdc
Frequency	47 to 63Hz
Inrush Current	40A max. @240Vac
Conducted EMI	CISPR/FCC Class B
Leakage Current	0.25mA max.

### OUTPUT SPECIFICATIONS

Hold-up Time	8ms typ. @115Vac
Short Circuit Protection	Continuous (Auto Recovery)
Over Voltage Protection	TVS Component to Clamp
Temperature Coefficient	±0.05%/°C

### SAFETY AND EMC

Emission and Immunity	EN55032 Class B, EN61000-6-3 EN61000-3-2, EN61000-3-3, EN55024, EN61204-3, EN61000-6-1
Safety	IEC60950-1, EN60950-1, UL60950-1

### GENERAL SPECIFICATIONS

Isolation	Input to output = 4,242VDC
Operating Temperature	0°C-85°C (see derating curve)
Storage Temperature	-20°C-85°C
Humidity	93% RH max. Non condensing
Cooling	Natural Convection
Switching Frequency	60KHz Typical
MTBF ..... MIL-HDBK-217F, GB, at 25°C/115VAC	200Khrs min.
Altitude	2000m
Dimensions	2.165 x 1.378 x 0.827 inches (55.00 x 35.00 x 21.00 mm)
Weight	35 g (0.08 Pounds)

### NOTE

1. Add a 0.1µF ceramic capacitor and a 10µF E.L. capacitor to output for ripple & noise measuring @20MHz BW.
2. Voltage accuracy is set at 100% rated load and 25°C.Ta.
3. Line regulation is measured from 100Vac to 240Vac with full load.
4. Load regulation is measured from 10% to 100% full load.
5. Typical efficiency at 230VAC and full load at 25°C.

# CFM06S SERIES

## 6 WATT SINGLE OUTPUT AC-DC OPEN FRAME

### Features

- ◆ Universal Input 90-264VAC
- ◆ High Efficiency up to 83%
- ◆ Approved EN55032 Class B and CISPR/FCC Class B
- ◆ Approved IEC62368-1, UL62368-1, EN62368-1
- ◆ Meets EN61558 (60335)
- ◆ Continuous Short Circuit Protection
- ◆ No Load Input Power < 75mW
- ◆ Over Voltage Protection
- ◆ Constant Current (Optional)
- ◆ Class II



### Ordering information

CFM06SXXX - X  
 Blank: PCB mount  
 E: Encapsulated  
 T: WAFER

### Mechanical Dimensions

All Dimensions In Inches[mm]  
 Tolerance:Inches:x.xxx= ± 0.02  
 Millimeters: x.xx = ± 0.5

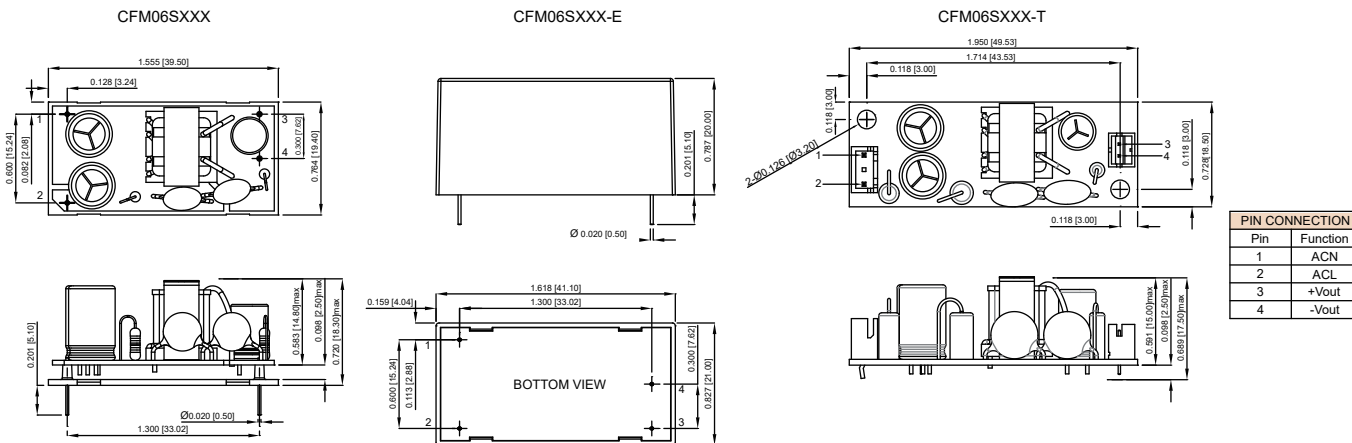

MODEL NUMBER	OUTPUT VOLTAGE	OUTPUT CURRENT	RIPPLE (mV p-p) (NOTE 1)	VOLTAGE ACCURACY (NOTE 2)	LINE REGULATION (NOTE 3)	LOAD REGULATION (NOTE 4)	% EFF. (Typ.) (NOTE 5)
CFM06S033	3.3 V	1.5 A	100mVp-p	±6%	±1%	±6%	75%
CFM06S050	5 V	1.2 A	100mVp-p	±5%	±1%	±5%	78%
CFM06S090	9 V	0.67 A	100mVp-p	±5%	±1%	±5%	81%
CFM06S120	12 V	0.5 A	120mVp-p	±3%	±1%	±3%	81%
CFM06S150	15 V	0.4 A	150mVp-p	±3%	±1%	±3%	81%
CFM06S240	24 V	0.25 A	240mVp-p	±3%	±1%	±3%	83%

## Derating Curve

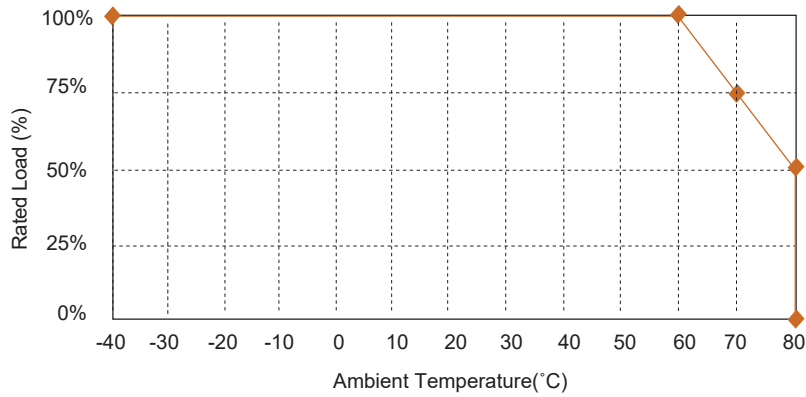

## Specifications

All Specifications Typical At Nominal Line, Full Load, and 25°C Unless Otherwise Noted

### INPUT SPECIFICATIONS

Voltage	90-264Vac, 120-370Vdc
Frequency	47 to 63Hz
Inrush Current	90A max. @240Vac, Cold Start @25°C
Leakage Current	0.25mA max. @ 264Vac
Input Current	0.25A max.

### OUTPUT SPECIFICATIONS

Holdup Time	12ms typ. @115Vac
Short Circuit Protection	Hiccup Mode (Auto Recovery)
Temperature Coefficient	±0.05%/°C

### SAFETY AND EMISSION

Emission and Immunity	EN55032 Class B, EN55024, EN61204-3 EN61000-3-2, -3, EN61000-6-1, 2, 3, 4 47 CFR FCC Part 15 Subpart B (Class B)
Safety	IEC62368-1, UL62368-1, EN62368-1, IEC60950-1

### GENERAL SPECIFICATIONS

Isolation Voltage(Input to Output)	3,000VAC
Operating Temperature	-40°C-80°C (Derating from 60°C to 80°C)
Storage Temperature	-40°C-85°C
Humidity	93% RH max. Non condensing
Cooling	Natural Convection
Switching Frequency	30-70KHz Typical
MTBF	MIL-HDBK-217F, GB, 25°C/115VAC 1120Khrs max.
Altitude	5000m
Life Time	56000 hours min.@ 75% load, 40°C
Dimensions	1.555x0.764x0.720 Inches (39.50x19.40x18.30mm) -E: 1.618x0.827x0.787 Inches (41.10x21.00x20.00mm) -T: 1.950x0.728x0.689 Inches (49.53x18.50x17.5mm)
Weight	11g, (-E): 30g, (-T): 12g

### NOTE

1. Add a 0.1uF ceramic capacitor and a 10uF E.L. capacitor to output for ripple&noise measuring @20MHz BW.
2. Voltage accuracy is set of 100% rated load.
3. Line regulation is measured from high line to low line with full load.
4. Load regulation is measured from 10% to 100% full load.
5. Typical efficiency at 230Vac and full load at 25°C
6. T Version wafer with JST B3B-XH / B4B-XH and mate with JST housing XH series or equivalent..



# CFM10, CFM15 SERIES

## 10 WATT, 15 WATT

### Features

- ◆ Universal Input Range 85-264VAC
- ◆ Efficiency to 83%
- ◆ Meets EN55032 Class B
- ◆ Continuous Short Circuit Protection
- ◆ Leakage Current 0.25mA Max.
- ◆ PCB Mountable

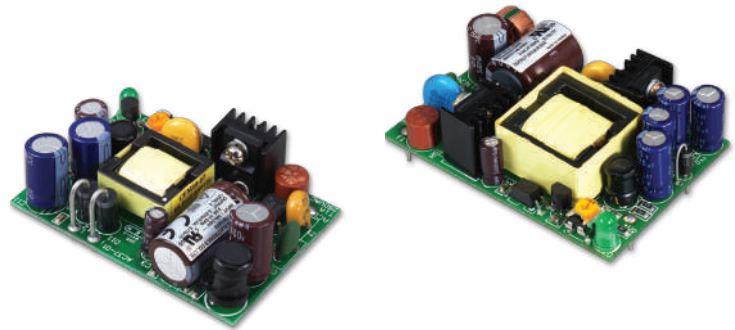

### Mechanical Dimensions

All Dimensions In Inches(mm)  
 Tolerance Inches: x.xxx= ±0.02  
 Millimeters: x.xx= ±0.5

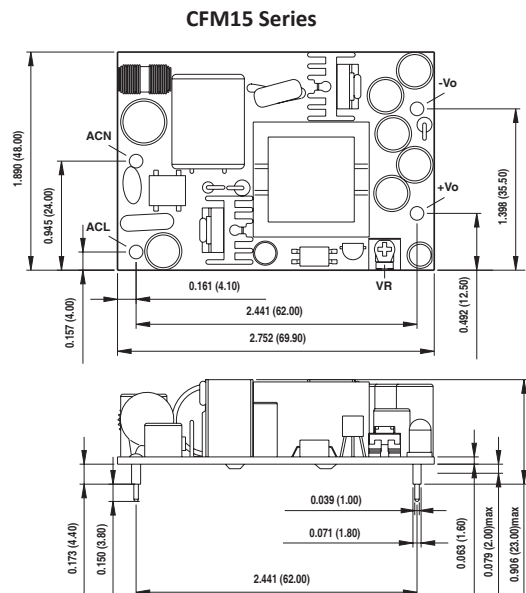
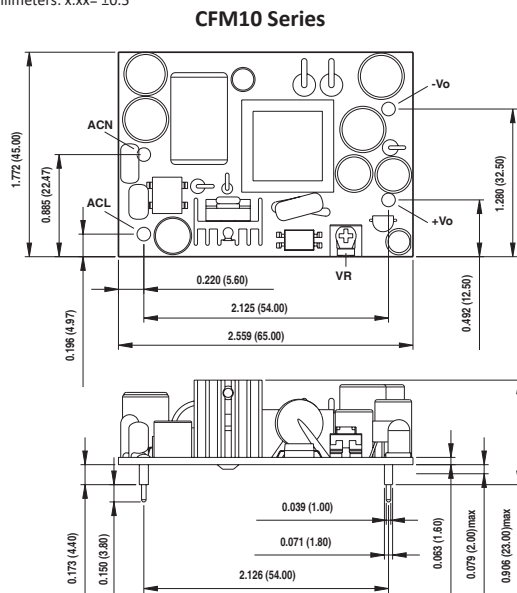

#### CFM10 Series

MODEL NUMBER	OUTPUT VOLTAGE	OUTPUT CURRENT	RIPPLE & NOISE (NOTE 1)	VOLTAGE ACCURACY	LINE REGULATION (NOTE 2)	LOAD REGULATION (NOTE 3)	% EFF. (TYP.) (NOTE 4)
CFM1001S	5 V	2000 mA	1%	± 1%	± 0.5%	± 1%	73%
CFM1002S	12 V	840 mA	1%	± 1%	± 0.5%	± 1%	76%
CFM1003S	15 V	670 mA	1%	± 1%	± 0.5%	± 1%	76%
CFM1005S	24 V	420 mA	1%	± 1%	± 0.5%	± 1%	77%
CFM1007S	3.3 V	2500 mA	50 mV	± 1%	± 0.5%	± 1%	67%
CFM1009S	9 V	1120 mA	1%	± 1%	± 0.5%	± 1%	72%

#### CFM15 Series

MODEL NUMBER	OUTPUT VOLTAGE	OUTPUT CURRENT	RIPPLE & NOISE (NOTE 1)	VOLTAGE ACCURACY	LINE REGULATION (NOTE 2)	LOAD REGULATION (NOTE 3)	% EFF. (TYP.) (NOTE 4)
CFM1501S	5 V	3000 mA	1%	± 1%	± 0.5%	± 1%	74%
CFM1502S	12 V	1250 mA	1%	± 1%	± 0.5%	± 1%	80%
CFM1503S	15 V	1000 mA	1%	± 1%	± 0.5%	± 1%	81%
CFM1505S	24 V	630 mA	1%	± 1%	± 0.5%	± 1%	83%
CFM1507S	3.3 V	3000 mA	50 mV	± 1%	± 0.5%	± 1%	69%
CFM1509S	9 V	1670 mA	1%	± 1%	± 0.5%	± 1%	76%



## Derating Curve

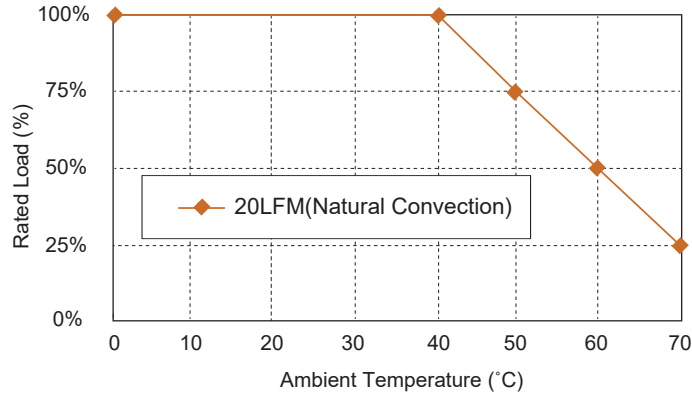

## Specifications

All Specifications Typical At Nominal Line, 75% Load and 25°C Unless Otherwise Noted

### INPUT SPECIFICATIONS

Voltage	85-264Vac, 120-370Vdc
Frequency	47 to 63Hz
Input Current	100Vac/0.5A max., 240Vac/0.25A max.
Inrush Current	Cold Start@25°C 20A max. @115Vac 40A max. @230Vac
Leakage Current	0.25mA max.

### OUTPUT SPECIFICATIONS

Hold-up Time	16ms typ. @115Vac
Short Circuit Protection	Hiccup Mode (Auto Recovery)
Over Voltage Protection	TVS Component to Clamp
Temperature Coefficient	0.05%/°C

### SAFETY AND EMC

Emission and Immunity	EN55032 Class B, EN61000-6-3 EN61000-3-2, EN61000-3-3, EN55024, EN61204-3, EN61000-6-1
Safety	IEC60950-1, EN60950-1, UL60950-1

### GENERAL SPECIFICATIONS

Isolation		Input to output = 4,242VDC
Operating Temperature		0°C-70°C (see derating curve)
Storage Temperature		-20-85°C
Humidity		93% RH max. Non condensing
Cooling		Natural Convection
Switching Frequency	CFM10:	100KHz Typical
	CFM15:	67KHz Typical
MTBF .....	MIL-HDBK-217F, GB, at 25°C/115VAC	200K hrs min.
Altitude		2000m
Dimensions	CFM10:	2.599 x 1.772 x 0.906 inches (65.00 x 45.00 x 23.00 mm)
	CFM15:	2.752 x 1.890 x 0.906 inches (69.90 x 48.00 x 23.00 mm)
Weight	CFM10:	60 g (0.13 Pounds)
	CFM15:	80 g (0.18 Pounds)

### NOTE

1. Add a 0.1µF ceramic capacitor and a 10µF E.L. capacitor to output for ripple & noise measuring @20MHz BW.
2. Line regulation is measured from high line to low line with full load.
3. Load regulation is measured from full to 10% load.
4. Typical efficiency with 230VAC and max. load at 25°C.

# CFM12S SERIES

## 12 WATT SINGLE OUTPUT AC-DC OPEN FRAME

### Features

- ◆ Universal Input 90-264VAC
- ◆ High Efficiency up to 87%
- ◆ Approved EN55032 Class B and CISPR/FCC Class B
- ◆ Approved IEC62368-1, UL62368-1, EN62368-1
- ◆ Meets EN60335-1
- ◆ Continuous Short Circuit Protection
- ◆ Over Voltage Protection
- ◆ No Load Input Power < 75mW
- ◆ Over Voltage Protection
- ◆ Class II

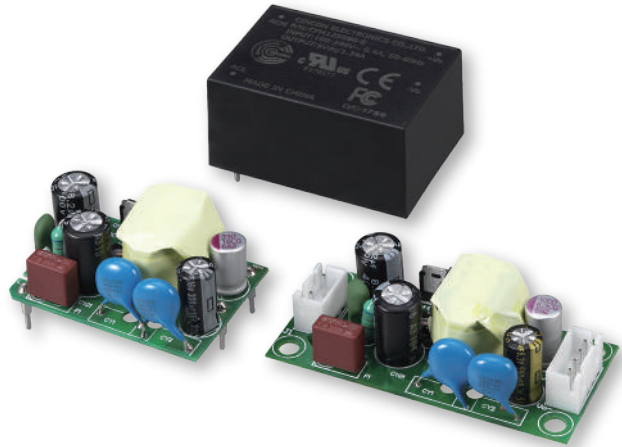

### Ordering information

CFM12SXXX - X  
 Blank: PCB mount  
 E: Encapsulated  
 T: WAFER

### Mechanical Dimensions

All Dimensions In Inches[mm]  
 Tolerance Inches:x.xxx= ± 0.02  
 Millimeters: x.xx = ± 0.5

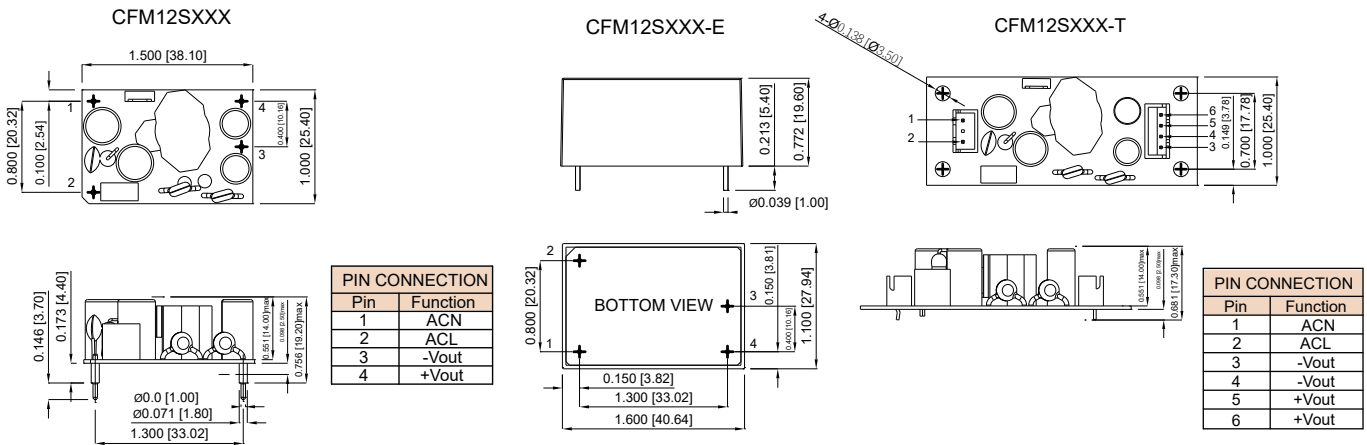

MODEL	OUTPUT VOLTAGE	OUTPUT CURRENT	RIPPLE (mVp-p) (NOTE 1)	VOLTAGE ACCURACY (NOTE 2)	LINE REGULATION (NOTE 3)	LOAD REGULATION (NOTE 4)	%EFF (typ.) (NOTE 5)
CFM12S050	5 V	2 A	100mV	±2%	±1%	±1%	80%
CFM12S090	9 V	1.34 A	100mV	±2%	±1%	±1%	85%
CFM12S120	12 V	1.0 A	120mV	±2%	±1%	±1%	85%
CFM12S150	15 V	0.8 A	150mV	±2%	±1%	±1%	85%
CFM12S240	24 V	0.5 A	240mV	±2%	±1%	±1%	87%

## Derating Curve

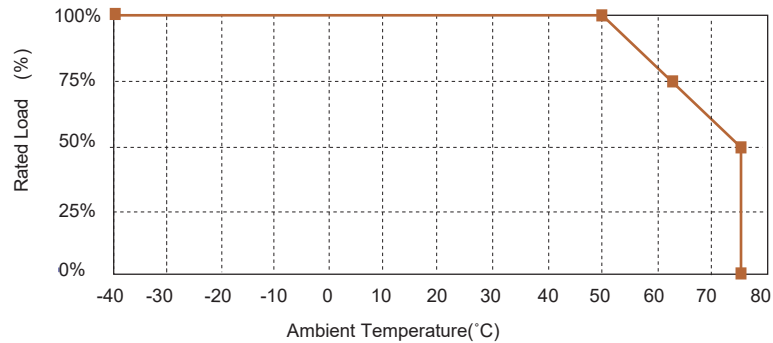

## Specifications

All Specifications Typical At Nominal Line, Full Load, and 25°C Unless Otherwise Noted

### INPUT SPECIFICATIONS

Voltage	90-264Vac, 120-370Vdc
Frequency	47 to 63Hz
Inrush Current	50A max. @240Vac, Cold Start @25°C
Leakage Current	0.25mA max. @ 264Vac
Input Current	0.4A max.

### OUTPUT SPECIFICATIONS

Holdup Time	10ms typ. @115Vac
Short Circuit Protection	Hiccup Mode (Auto Recovery)
Temperature Coefficient	±0.05% / °C
Over Voltage Protection	Hiccup Mode(Auto Recovery)
Startup time	<3.0s

### SAFETY AND EMISSION

Emission and Immunity	EN55032 Class B, EN55024, EN61204-3 EN61000-3-2, -3, EN61000-6-1, 2, 3, 4 47 CFR FCC Part 15 Subpart B (Class B)
Safety	IEC62368-1, UL62368-1, EN62368-1 IEC60950-1, UL60950-1

### GENERAL SPECIFICATIONS

Isolation Voltage(Input to Output)	3000VAC:
Operating Temperature	-40°C-75°C (Derating from 50°C to 75°C)
Storage Temperature	-40°C-85°C
Cooling	Natural Convection
Humidity	93% RH max. Non condensing
Switching Frequency	65KHz Typical
MTBF	MIL-HDBK-217F, GB, 25°C/115VAC 870Khrs max.
Altitude	5000m
Dimensions	1.500x1.000x0.764inches (38.10x25.40x19.40mm) -E: 1.600x1.1x0.772 Inches (40.64x27.94x19.60 mm) -T: 2.150x1.000x0.681 Inches (54.61x25.40x17.30 mm)
Weight	16g, (-E): 40g, (-T): 17g

### NOTE

1. Add a 0.1uF ceramic capacitor and a 10uF E.L. capacitor to output for ripple&noise measuring @20MHz BW.
2. Voltage accuracy is set of 100% rated load.
3. Line regulation is measured from high line to low line with full load.
4. Load regulation is measured from 10% to 100% full load.
5. Typical efficiency at 230Vc and full load at 25°C
6. T Version wafer with JST B3B-XH / B4B-XH and mate with JST housing XH series or equivalent..

# CFM20 SERIES

## 20 WATT

### Features

- ◆ Universal Input Range 85-264Vac
- ◆ Efficiency to 81%
- ◆ Industry Standard Pin Out
- ◆ Meets EN55032 Class B
- ◆ Continuous Short Circuit Protection
- ◆ PCB Mountable Type is available

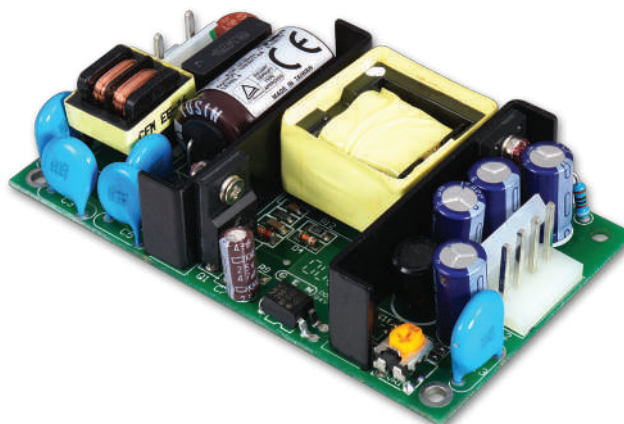

### Mechanical Dimensions

All Dimensions in Inches (mm)  
 Tolerance Inches: X.XXX=±0.02  
 Millimeters: X.X=±0.5

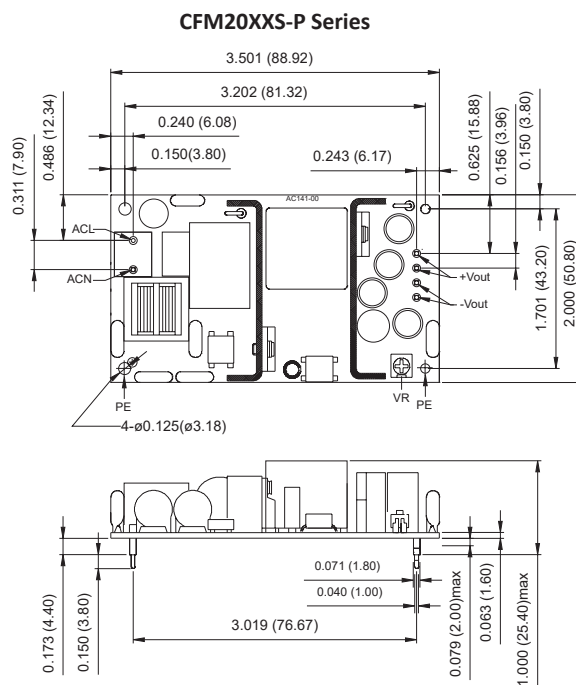
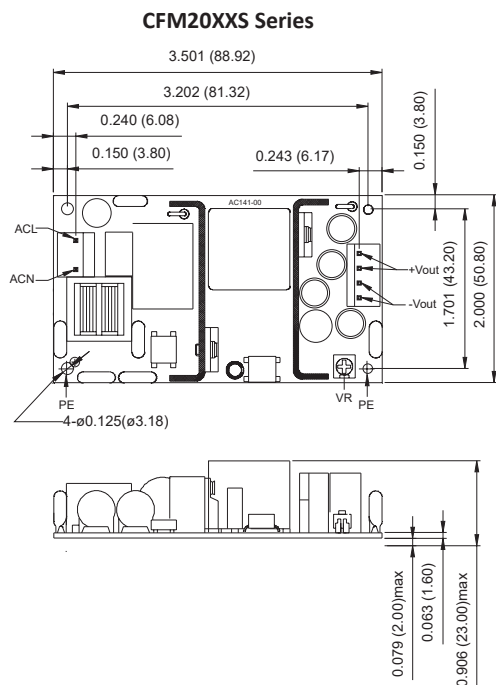

MODEL NUMBER	OUTPUT VOLTAGE	MIN. LOAD	MAX. LOAD	RIPPLE & NOISE NOTE 1	VOLTAGE ACCURACY NOTE 2	LINE REGULATION NOTE 3	LOAD REGULATION NOTE 4	% EFF (Typ.) NOTE 5
CFM2001S	5 V	0 A	4400 mA	1%	±1%	±0.5%	±1%	72%
CFM2002S	12 V	0 A	1800 mA	1%	±1%	±0.5%	±1%	79%
CFM2003S	15 V	0 A	1400 mA	1%	±1%	±0.5%	±1%	80%
CFM2005S	24 V	0 A	920 mA	1%	±1%	±0.5%	±1%	81%
CFM2007S	3.3 V	0 A	4400 mA	50mV	±1%	±0.5%	±1%	66%
CFM2009S	9 V	0 A	2450 mA	1%	±1%	±0.5%	±1%	76%

## Derating Curve

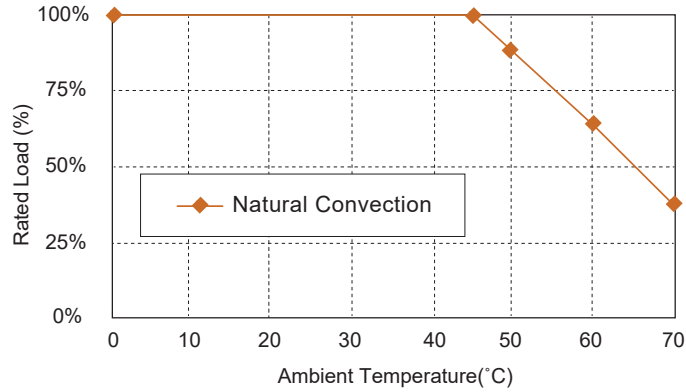

## Specifications

All Specifications Typical At Nominal Line, 75% Load and 25°C Unless Otherwise Noted

### INPUT SPECIFICATIONS

Voltage	85-264Vac, 120-370Vdc
Frequency	47 to 63Hz
Inrush Current	40A max. @230Vac
Conducted EMI	CISPR/FCC Class B
Leakage Current	3.5mA max.

### OUTPUT SPECIFICATIONS

Hold-up Time	16ms typ. @115Vac
Short Circuit Protection	Hiccup Mode (Auto Recovery)
Over Voltage Protection	TVS Component to Clamp
Temperature Coefficient	±0.05%/°C

### SAFETY AND EMC

Emission and Immunity	EN55032 Class B EN61000-6-3, EN61000-3-2, EN61000-3-3, EN55024, EN61204-3, EN61000-6-1
Safety	IEC60950-1, EN60950-1, UL60950-1

### GENERAL SPECIFICATIONS

Isolation	Input to output = 4,242VDC
Operating Temperature	0-70°C (see derating curve)
Storage Temperature	-20-85°C
Humidity	93% RH max. Non condensing
Cooling	Natural Convection
Switching Frequency	67KHz Typical
MTBF ..... MIL-HDBK-217F, GB, 25°C/115VAC	300Khrs min.
Altitude	2000m
Dimensions	3.501 x 2.000 x 0.906 inches (88.92 x 50.80 x 23.00 mm)
	(CFM20XXS-P) 3.501 x 2.000 x 1.000 inches (88.92 x 50.80 x 25.40 mm)
Weight	100 g (0.22 Pounds)

### NOTE

1. Add a 0.1µF ceramic capacitor and a 10µF E.L. capacitor to output for ripple & noise measuring @20MHz BW.
2. Voltage accuracy is set at 100% rated load and 25°C Ta.
3. Line regulation is measured from high line to low line with full load.
4. Load regulation is measured from full to 10% load.
5. Typical efficiency at 230VAC and full load at 25°C.
6. Standard input and output connectors wafer with LONG CHU P3060 series and mate with MOLEX housing 5195 series or equivalent.
7. Model "CFM200XS-P": Connectors with pcb mountable type.

# CFM21 SERIES

## 20 WATT, LOW PROFILE 0.8"

### Features

- ◆ Universal Input Range 90-264VAC
- ◆ Miniature Size Low Profile 0.8"
- ◆ Industry-Standard Pin Out
- ◆ Efficiency to 85%
- ◆ Continuous Short Circuit Protection
- ◆ Over Voltage Protection
- ◆ No Load Input Power < 0.3W
- ◆ Leakage Current < 0.1mA
- ◆ UL60601-1/IEC60601-1/EN60601-1 Medical Safety Approved
- ◆ UL60950-1/IEC60950-1/EN60950-1 ITE Safty Approved
- ◆ Option for On-Board, Connector, Screw Terminal and Encapsulated type



### Mechanical Dimensions

All Dimensions in Inches (mm)  
 Tolerance Inches: X.XXX=±0.02, X.XXX=±0.01  
 Millimeters: X.XX=±0.5, X.XX=±0.25

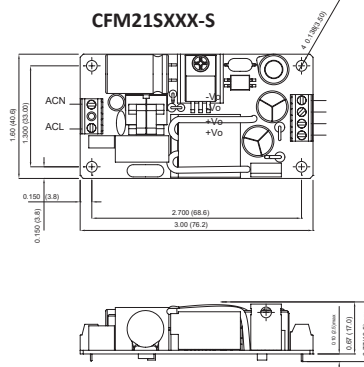
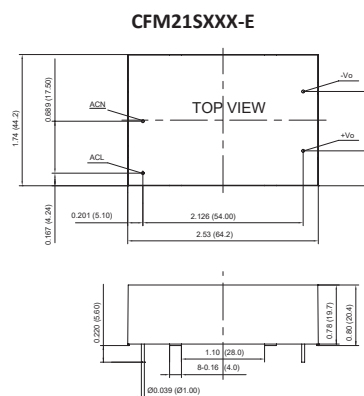
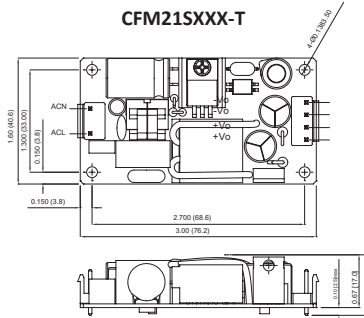
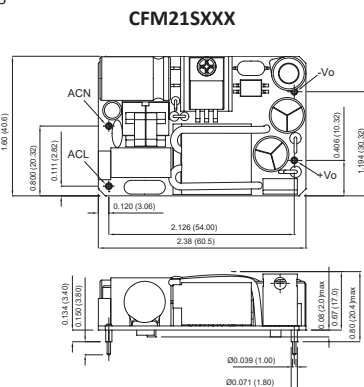

MODEL NUMBER	INPUT VOLTAGE	OUTPUT VOLTAGE	MIN. LOAD	MAX. LOAD	OUTPUT RATED POWER	RIPPLE & NOISE	VOLTAGE ACCURACY	% EFF.
CFM21S033	90-264 VAC	3.3 V	0 A	4.0 A	13.2 W	50 mV	±1%	75%
CFM21S050	90-264 VAC	5 V	0 A	4.0 A	20.0 W	50 mV	±1%	80%
CFM21S090	90-264 VAC	9 V	0 A	2.3 A	20.7 W	90 mV	±1%	81%
CFM21S120	90-264 VAC	12 V	0 A	1.7 A	20.4 W	100 mV	±1%	83%
CFM21S150	90-264 VAC	15 V	0 A	1.4 A	21.0 W	100 mV	±1%	84%
CFM21S240	90-264 VAC	24 V	0 A	0.9 A	21.6 W	100 mV	±1%	85%

## Derating Curve

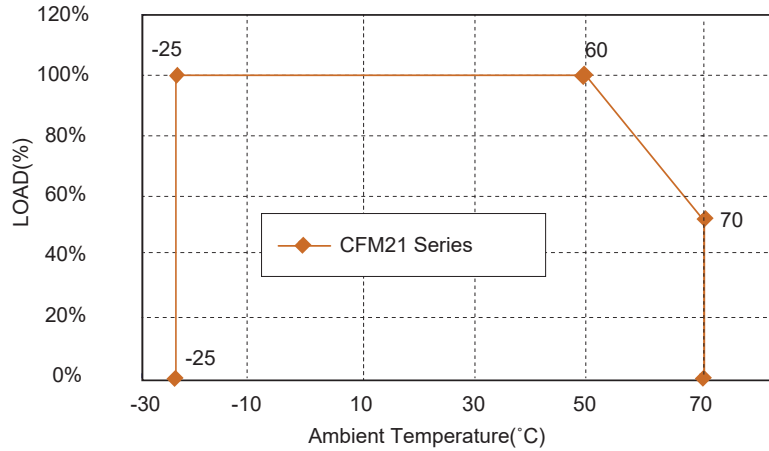

## Specifications

All Specifications Typical At Nominal Line, 75% Load and 25°C Unless Otherwise Noted

### INPUT SPECIFICATIONS

Voltage	90-264Vac, 120-370Vdc
Frequency	47 to 63Hz
Input Current	0.3 to 0.5A
Inrush Current	Cold Start @25°C 40A max. @230Vac
Leakage Current	0.1mA max.

### OUTPUT SPECIFICATIONS

Voltage Accuracy:	±1.0% max.
Line Regulation (note 3)	±0.5% max.
Load Regulation (note 4)	±1.0% max.
Hold-up Time	10ms typ. @115Vac
Short Circuit Protection	Continuous
Over Voltage Protection (TVS)	115%-140% of nominal output voltage

### SAFETY AND EMISSION

CE Directive	2004/108/EC, 93/42/EEC
Emissions	EN60601-1/EN61204-3/ EN55022/ CISPR Class B EN55024
Safety Approvals	UL60601-1, IEC60601-1, EN60601-1, UL60950-1, IEC60950-1, EN60950-1

### GENERAL SPECIFICATIONS

Efficiency	see Table
Switching Frequency	100KHz typ.
Isolation	Input to output = 5,656VDC
Operating Temperature	-25-70°C (with de-rating)
Storage Temperature	-40-85°C
Cooling	Natural Convection
Humidity	93% RH max. Non condensing
MTBF ..... MIL-STD-217F, GB	650Khrs min.
Dimensions	2.38 x 1.60 x 0.80 inches (60.5 x 40.6 x 20.4 mm) -T: 3.00 x 1.60 x 0.77 inches (76.2 x 40.6 x 19.5 mm) -E: 2.53 x 1.74 x 0.80 inches (64.2 x 44.2 x 20.4 mm) -S: 3.00 x 1.60 x 0.77 inches (76.2 x 40.6 x 19.5 mm)
Weight	50 g, 55 g (-T, -S), 105 g (-E)

### NOTE

1. Voltage accuracy is set of 100% rated load.
2. Add a 0.1µF ceramic capacitor and a 10µF E.L. capacitor to output for ripple & noise measuring @20MHz BW.
3. Line regulation is measured from high line to low line with full load.
4. Load regulation is measured from 10% to 100% full load.
5. "T" Version Connection: JST B3P-VH / B4P-VH or equivalent.
6. "S" Version Connection: DECA MB332-381A or equivalent.



# CFM25S SERIES

## 25 WATT SINGLE OUTPUT AC-DC OPEN FRAME

### Features

- ◆ Universal Input 90-264VAC
- ◆ High Efficiency up to 87%
- ◆ Meets EN55032 Class B and CISPR/FCC Class B
- ◆ Meets IEC/EN60335-1, IEC61558-1
- ◆ Safety Approved IEC/EN/UL60950-1, IEC/EN/UL62368-1
- ◆ Continuous Short Circuit Protection
- ◆ Over Voltage Protection
- ◆ Peak Load (2 Times of Rated Current (note7))
- ◆ No Load Input Power<0.1W
- ◆ Class II



### Ordering information

CFM25SXXX -	X	YZ (Optional)
	Blank: PCB mount	Blank
	E: Encapsulated	PL: Peak Load Function
	T: WAFER	with Pin5 (BC+), Pin6(BC-)

### Mechanical Dimensions

All Dimensions In Inches[mm]  
 Tolerance Inches:x.xxx= ± 0.02  
 Millimeters: x.xx = ± 0.5

PIN CONNECTION	
Pin	Function
1	ACL
2	ACN
3	+Vout
4	+Vout
5	-Vout
6	-Vout

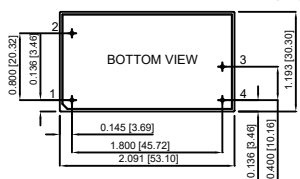
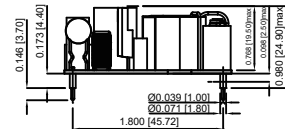
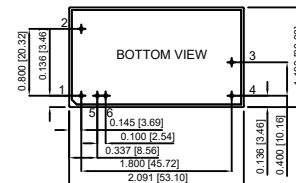
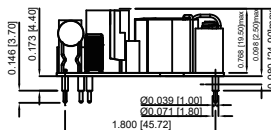
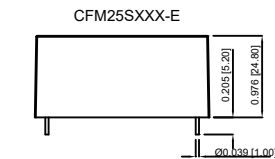
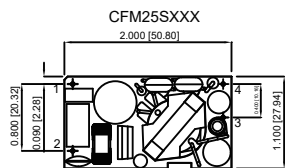
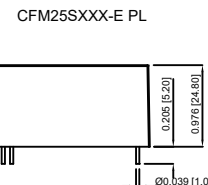
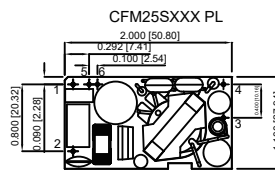
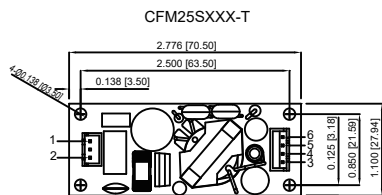

PIN CONNECTION	
Pin	Function
1	ACL
2	ACN
3	+Vout
4	-Vout

PIN CONNECTION	
Pin	Function
1	ACL
2	ACN
3	+Vout
4	-Vout
5	BC+
6	BC-

MODEL	OUTPUT VOLTAGE	OUTPUT CURRENT	RIPPLE (mVp-p) (NOTE 1)	VOLTAGE ACCURACY (NOTE 2)	LINE REGULATION (NOTE 3)	LOAD REGULATION (NOTE 4)	%EFF (typ.) (NOTE 5)
CFM25S050	5 V	4.0 A	50mV	±2%	±1%	±1%	81%
CFM25S120	12 V	2.1 A	120mV	±1%	±1%	±1%	84%
CFM25S150	15 V	1.67 A	150mV	±1%	±1%	±1%	85%
CFM25S240	24 V	1.05A	240mV	±1%	±1%	±1%	86%
CFM25S360	36 V	0.7 A	360mV	±1%	±1%	±1%	87%
CFM25S480	48 V	0.52 A	480mV	±1%	±1%	±1%	87%

## Derating Curve

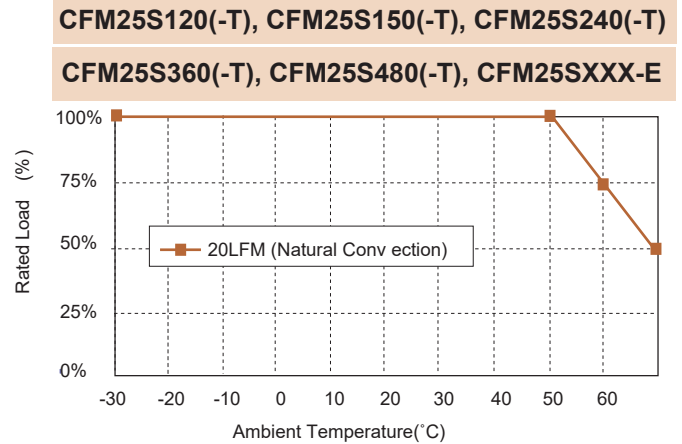
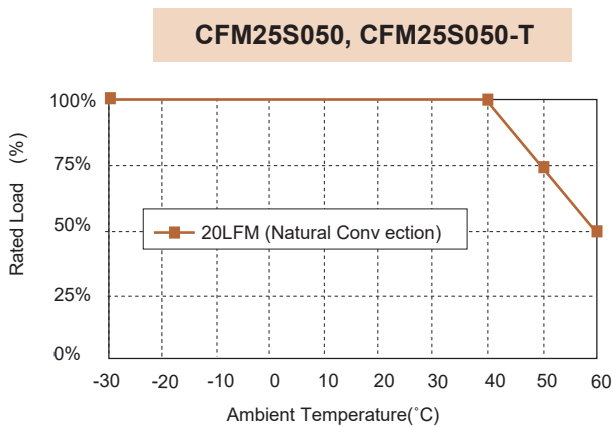

## Specifications

All Specifications Typical At Nominal Line, Full Load, and 25°C Unless Otherwise Noted

### INPUT SPECIFICATIONS

Voltage	90-264Vac, 120-370Vdc
Frequency	47 to 63Hz
Inrush Current	60A max. @240Vac, Cold Start @25°C
Leakage Current	0.25mA max. @ 264Vac
Input Current	0.7A max

### OUTPUT SPECIFICATIONS

Holdup Time	8ms typ. @115Vac
Short Circuit Protection	Hiccup Mode (Auto Recovery)
Temperature Coefficient	±0.05% / °C
Over Voltage Protection	TVS Component to Clamp
Startup time	<3.0s

### SAFETY AND EMISSION

Emission and Immunity	EN55032 Class B, FCC Part 15 Class B EN61000-6-3, EN61000-6-4, EN61000-3-2, EN6100-3-3
Immunity	EN55024, EN61204-3, EN61000-6-1, EN61000-6-2
Safety	IEC/EN/UL60950-1, IEC/EN/UL62368-1

### GENERAL SPECIFICATIONS

Isolation Voltage(Input to Output)	3000VAC:
Operating Temperature	-30°C-70°C (Derating from 50°C to 70°C)
Storage Temperature	-30°C-85°C
Cooling	Natural Convection
Humidity	93% RH max. Non condensing
Switching Frequency	65KHz Typical
MTBF	MIL-HDBK-217F, GB, 25°C/115VAC 500Khrs min
Life time	26000 hours min.@ 75% Load, 40°C 5000m(UL60950-1), 3000m(IEC61558-1)
Altitude	2.000x1.100x0.980Inches (50.80x27.94x24.90mm)
Dimensions	-E: 2.091x1.193x0.976Inches (53.10x30.30x24.80mm) -T: 2.776x1.100x0.906 Inches (70.50x27.94x23.00 mm)
Weight	50g, 105g(-E), 55g(-T)

### NOTE

1. Add a 0.1uF ceramic capacitor and a 10uF E.L. capacitor to output for ripple & noise measuring @20MHz BW.
2. Voltage accuracy is set at 100% rated load and 25°C Ta.
3. Line regulation is measured from high line to low line with full load.
4. Load regulation is measured from 10% to 100% full load.
5. Typical efficiency at 230vac and full load at 25°C.
6. T Version wafer with JST B3B-XH / B4B-XH and mate with JST housing. XH series or equivalent.
7. PL(peak load function) lasting time <10 seconds with a maximum 10% duty cycle and must add external 33uF/400V capacitor to BC+ & BC-

# CFM40, CFM60 SERIES

## 40 WATT, 60 WATT, 2" X 4" OPEN FRAME

### Features

- ◆ Universal Input Range 90-264VAC
- ◆ 2" x 4" Size
- ◆ Industry Standard Pin Out
- ◆ Efficiency to 87%
- ◆ Meets EN55032 Class B and CISPR/FCC Class B
- ◆ Continuous Short Circuit Protection

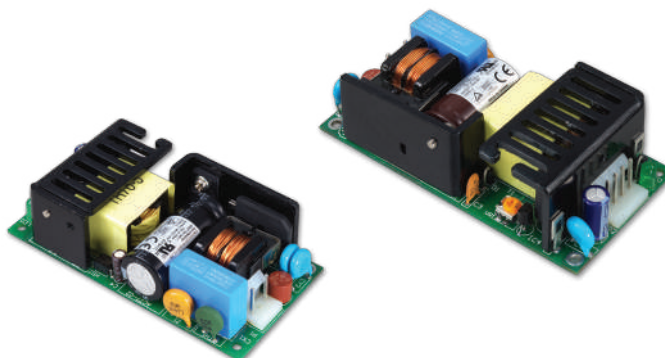

### Mechanical Dimensions

All Dimensions In Inches(mm)  
Tolerance Inches: x.xxx= ±0.02  
Millimeters: x.xx= ±0.5

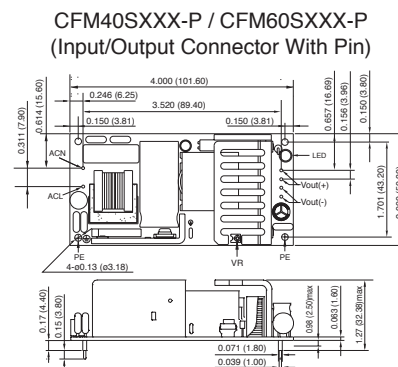
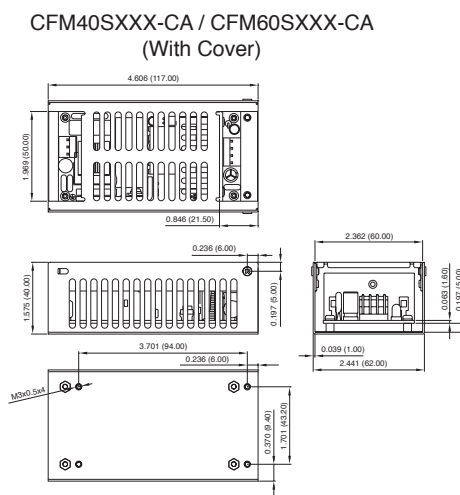
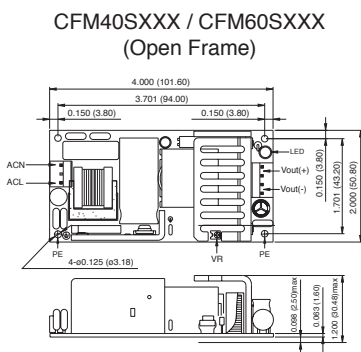

### CFM40 Series

MODEL NUMBER	OUTPUT VOLTAGE	OUTPUT CURRENT	RIPPLE & NOISE	VOLTAGE ACCURACY	LINE REGULATION	LOAD REGULATION	% EFF. (Typ.)
CFM40S033	3.3 V	6 A	50 mV	± 1%	± 0.5%	± 1%	70%
CFM40S050	5 V	6 A	1%	± 1%	± 0.5%	± 1%	76%
CFM40S090	9 V	4.45 A	1%	± 1%	± 0.5%	± 1%	84%
CFM40S120	12 V	3.34 A	1%	± 1%	± 0.5%	± 1%	85%
CFM40S150	15 V	2.67 A	1%	± 1%	± 0.5%	± 1%	85%
CFM40S240	24 V	1.67 A	1%	± 1%	± 0.5%	± 1%	85%
CFM40S300	30 V	1.33 A	1%	± 1%	± 0.5%	± 1%	86%
CFM40S360	36 V	1.11 A	1%	± 1%	± 0.5%	± 1%	87%
CFM40S480	48 V	0.834 A	1%	± 1%	± 0.5%	± 1%	87%

### CFM60 Series

MODEL NUMBER	OUTPUT VOLTAGE	OUTPUT CURRENT	RIPPLE & NOISE	VOLTAGE ACCURACY	LINE REGULATION	LOAD REGULATION	%EFF. (Typ.)
CFM60S033	3.3 V	8 A	50 mV	± 1%	± 0.5%	± 1%	72%
CFM60S050	5 V	8 A	1%	± 1%	± 0.5%	± 1%	77%
CFM60S090	9 V	6.67 A	1%	± 1%	± 0.5%	± 1%	84%
CFM60S120	12 V	5 A	1%	± 1%	± 0.5%	± 1%	85%
CFM60S150	15 V	4 A	1%	± 1%	± 0.5%	± 1%	86%
CFM60S240	24 V	2.5 A	1%	± 1%	± 0.5%	± 1%	86%
CFM60S300	30 V	2 A	1%	± 1%	± 0.5%	± 1%	86%
CFM60S360	36 V	1.67 A	1%	± 1%	± 0.5%	± 1%	88%
CFM60S480	48 V	1.25 A	1%	± 1%	± 0.5%	± 1%	88%

## Derating Curve

### CFM40SXXX / CFM60SXXX (Open Frame)

CFM40S050, 40S090, 60S033, 60S050, 60S090

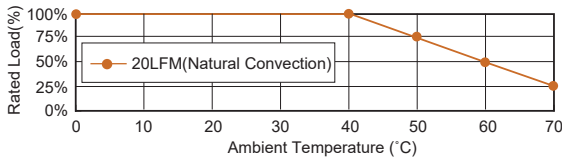

CFM40S120, 40S150, 40S240, 40S300, 40S360, 40S480  
CFM60S120, 60S150, 60S240, 60S300, 60S360, 60S480

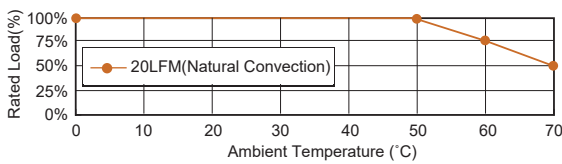

### CFM40SXXX-CA / CFM60SXXX-CA (With Cover)

CFM40S120, 40S150, 40S240, 40S300, 40S360, 40S480

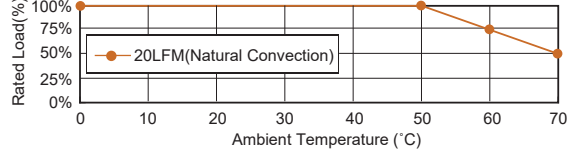

CFM40S033, CFM40S050, CFM60S033, CFM60S050

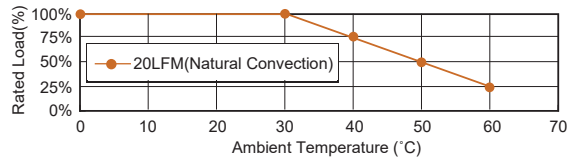

CFM40S090, 60S090, 60S120, 60S150, 60S240, 60S300  
CFM60S360, 60S480

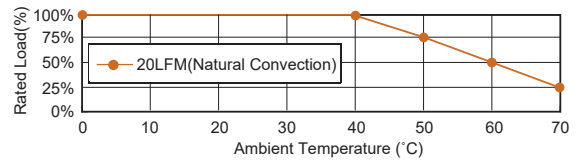

## Specifications

All Specifications Typical At Nominal Line, 75% Load and 25°C Unless Otherwise Noted

### INPUT SPECIFICATIONS

Voltage	90-264Vac, 120-370Vdc
Frequency	47 to 63Hz
Inrush Current	Cold start@25°C 50A max. @240Vac
Leakage Current	1mA max.

### OUTPUT SPECIFICATIONS

Hold-up Time	8ms typ. @115Vac
Short Circuit Protection	Hiccup Mode (Auto Recover)
Over Voltage Protection	TVS Component to Clamp
Temperature Coefficient	±0.05%/°C

### SAFETY AND EMC

Emission and Immunity	EN55032 Class B, FCC Part 15 Class B, EN61000-6-3, EN61000-3-2, EN61000-3-3, EN55024, EN61204-3, EN61000-6-1
Safety	IEC60950-1, EN60950-1, UL60950-1

### GENERAL SPECIFICATIONS

Isolation	Input to Output = 4,242VDC
Operating Temperature	0°C-70°C (see derating curve)
Storage Temperature	-20°C-85°C
Humidity	93% RH max. Non-Condensing
Cooling	Natural Convection
Switching Frequency	66KHz Typical
MTBF ..... MIL-HDBK-217F, GB, 25°C/115VAC	200K hrs min.
Altitude	2000m
Dimensions:	
CFM40/60 Open Frame	4.000 x 2.000 x 1.200 inches (101.60 x 50.80 x 30.48 mm)
-P	4.000 x 2.000 x 1.275 inches (101.60 x 50.80 x 32.38 mm)
CFM40/60 Covered	4.606 x 2.441 x 1.575 inches (117.00 x 62.00 x 40.00 mm)
Weight	CFM40/60: 170g/175g (0.38/0.39 Pounds) CFM40/60 Covered: 210g/215g (0.46/0.47 Pounds)

### NOTE

1. Add a 0.1µF ceramic capacitor and a 10µF E.L. capacitor to output for ripple & noise measuring @20MHz BW.
2. Line regulation is measured from High Line to low Line with full load.
3. Load regulation is measured from Full to 10% load.
4. Input connector mates with molex housing 09-50-3031 and molex 2878 series crimp terminal.
5. Output connector mates with molex housing 09-50-3041 and molex 2878 series crimp terminal.
6. Safety approvals do not apply to the Covered versions, only to the Open-Frame versions.

# CFM41S SERIES

## 40 WATT SINGLE OUTPUT AC-DC OPEN FRAME

### Features

- ◆ Universal Input 90-264VAC
- ◆ EN55032 Class B and CIRSS/FCC Class B
- ◆ IEC62368-1, UL62368-1, EN62368-1
- ◆ Meets IEC/EN60335-1
- ◆ Continuous Short Circuit Protection
- ◆ Over Voltage Protection
- ◆ No Load Power Consumption < 0.15W
- ◆ Peak Load (2 times of rated current)
- ◆ Class II



**PRELIMINARY**

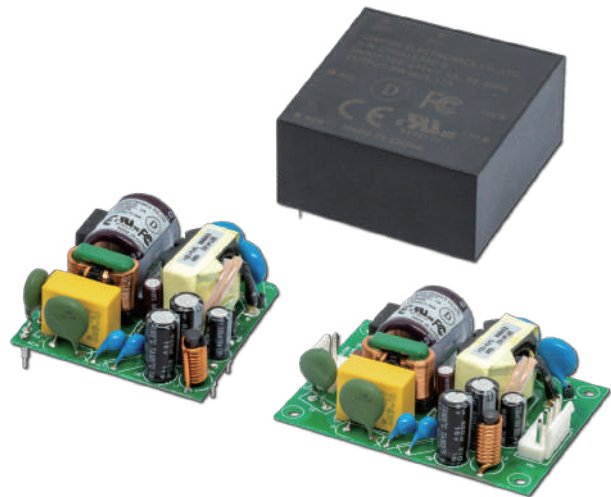

### Mechanical Dimensions

CFM41SXXX - X  
 Blank: PCB mount  
 E: Encapsulated  
 T: WAFER

### Mechanical Dimensions

All Dimensions In Inches[mm]  
 Tolerance:Inches:x.xxx= ± 0.02  
 Millimeters: x.xx = ± 0.5

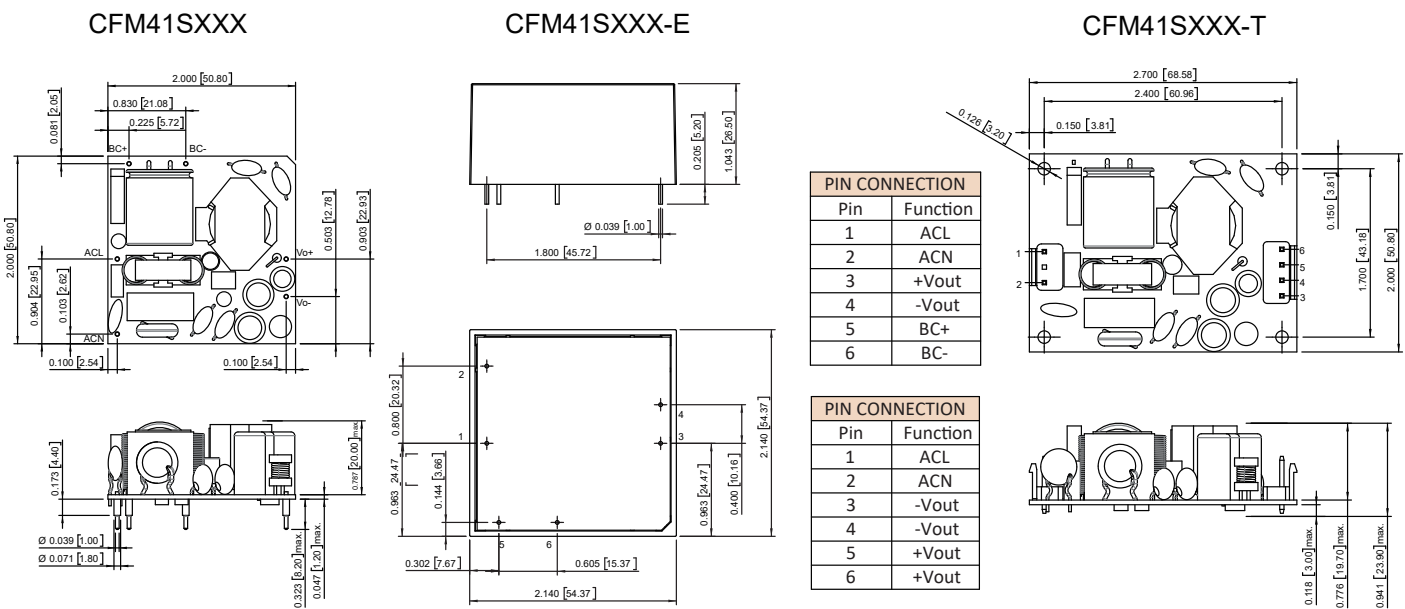

Pin	Function
1	ACL
2	ACN
3	+Vout
4	-Vout
5	BC+
6	BC-

Pin	Function
1	ACL
2	ACN
3	-Vout
4	-Vout
5	+Vout
6	+Vout

MODEL NUMBER	OUTPUT VOLTAGE	OUTPUT CURRENT	PEAK CURRENT (NOTE 6)	RIPPLE NOISE (NOTE 2)	VOLTAGE ACCURACY (NOTE 1)	LINE REGULATION (NOTE 3)	LOAD REGULATION (NOTE 4)	% EFF. (Typ.) (NOTE 5)
CFM41S050	5 V	6 A	12 A	100mV	±2%	±1%	±1%	87%
CFM41S120	12 V	3.34 A	6.66 A	120mV	±1%	±1%	±1%	90%
CFM41S150	15 V	2.67 A	5.34 A	150mV	±1%	±1%	±1%	90%
CFM41S240	24 V	1.67 A	3.34 A	240mV	±1%	±1%	±1%	90%
CFM41S050	36 V	1.11 A	2.22 A	360mV	±1%	±1%	±1%	90%
CFM41S360	48 V	0.83 A	1.66 A	480mV	±1%	±1%	±1%	90%

## Derating Curve

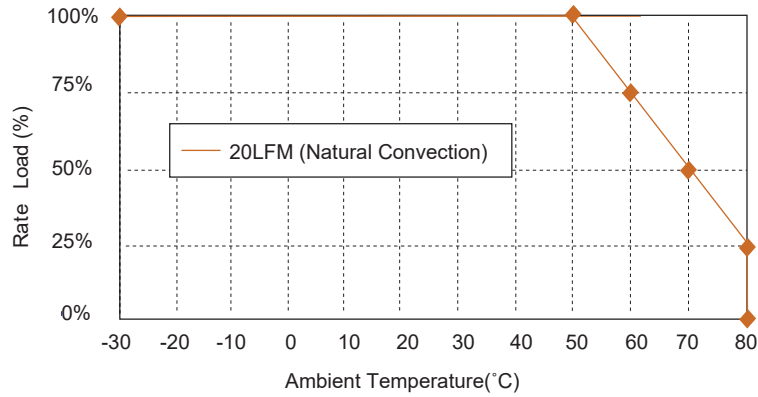

## Specifications

All Specifications Typical At Nominal Line, Full Load, and 25°C Unless Otherwise Noted

### INPUT SPECIFICATIONS

Voltage	90-264Vac, 120-370Vdc
Frequency	47-63Hz
Inrush Current	70A max. @240Vac, Cold Start @25°C
Input Current	100Vac/1A max., 240Vac/0.55A max.
Leakage Current	0.25mA max. @ 264Vac

### OUTPUT SPECIFICATIONS

Holdup Time	10ms typ. @115Vac
Short Circuit Protection	Hiccup Mode (Auto Recovery)
Over Voltage Protection	TVS Component to Clamp
Temperature Coefficient	±0.05%/°C
Startup time	115Vac<2s tpy., 230Vac<1s typ.
Switching Frequency	65KHz Typica.

### SAFETY AND EMISSION

Emission and Immunity	EN55032 CLASS B, FCC Part 15 Class B EN61000-3-2, EN61000-3-3, EN61000-6-3 EN61000-6-4
Immunity	EN55024, EN61204-3, EN61000-6-1, EN61000-6-2
Safety	Class II, IEC/EN/UL 62368-1

### GENERAL SPECIFICATIONS

Isolation Voltage (Input to Output)	3,000VAC
Operating Temperature	-30°C-85°C (Derating from 50°C to 80°C) -40°C can be start up at full load -40-85°C
Storage Temperature	-40-85°C
MTBF	350KHours min.
Altitude	5000m
Life Time	26000 hours min. @ 75% load, 40°C
Dimensions	2.000x2.000x1.01 inches (50.80x50.80x25.6mm) -E: 2.14x2.14x1.035 inches (54.37x54.37x26.5mm) -T: 2.70x2.00x0.941 inches (68.58x50.80x23.9mm)
Weight	61g, 142g(-E), 64g(-T)

### NOTE

1. Voltage accuracy is set of 100% rated load.
2. Add a 0.1uF ceramic capacitor and a 10uF E.L. capacitor to output for Ripple & Noise measuring @20MHz BW.
3. Line regulation is measured from high line to low line with full load.
4. Load regulation is measured from 10% to 100% full load.
5. Typical efficiency at 230VAC and full load at 25°C
6. PL(Peak load function) Lasting time < 10 seconds with a maximum 10% duty cycle And must add external 68uF / 400V capacitor to BC+ & BC-.
7. CFM41SXXX-T input and output connectors (CN1 and CN2) wafer with TAIWAN KING PIN TERMINAL PVHI series and mate with JST housing VHR series or equivalent.

# CFM61S SERIES

## 60 WATT SINGLE OUTPUT AC-DC OPEN FRAME

### Features

- ◆ Universal Input 90-264VAC
- ◆ High Efficiency up to 90%
- ◆ Meets EN55032 Class B and CISRP/FCC Class B
- ◆ Approved IEC62368-1, UL62368-1, EN62368-1
- ◆ Continuous Short Circuit Protection
- ◆ Over Voltage Protection
- ◆ Peak Load (2 times of rated current (note7))
- ◆ No Load Power Consumption < 0.15W
- ◆ Class II



### Ordering information

<b>CFM61SXXX - X</b>	<b>YZ (Optional)</b>
Blank: PCB mount	Blank
E: Encapsulated	PL: PEAK LOAD FUNCTION
T: WAFER	

### Mechanical Dimensions

All Dimensions In Inches[mm]  
 Tolerance Inches:x.xxx= ± 0.02  
 Millimeters: x.xx = ± 0.5

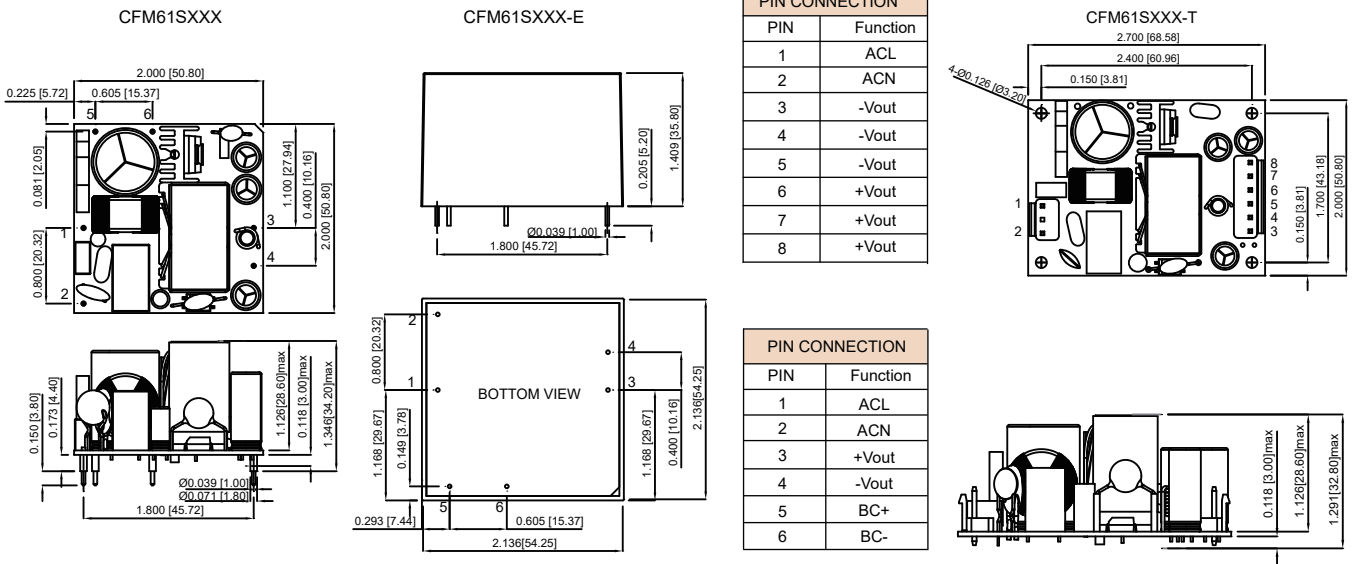

PIN CONNECTION	
PIN	Function
1	ACL
2	ACN
3	-Vout
4	-Vout
5	-Vout
6	+Vout
7	+Vout
8	+Vout

PIN CONNECTION	
PIN	Function
1	ACL
2	ACN
3	+Vout
4	-Vout
5	BC+
6	BC-

MODEL	OUTPUT VOLTAGE	OUTPUT CURRENT	RIPPLE & NOISE (NOTE 1)	VOLTAGE ACCURACY (NOTE 2)	LINE REGULATION (NOTE 3)	LOAD REGULATION (NOTE 4)	% EFF
CFM61S050	5 V	8 A	50mV	±2%	±1%	±1%	86%
CFM61S120	12 V	5 A	120mV	±1%	±1%	±1%	88%
CFM61S150	15 V	4 A	150mV	±1%	±1%	±1%	88%
CFM61S240	24 V	2.5 A	240mV	±1%	±1%	±1%	89%
CFM61S360	36 V	1.67 A	360mV	±1%	±1%	±1%	89%
CFM61S480	48 V	1.25 A	480mV	±1%	±1%	±1%	90%



## Derating Curve

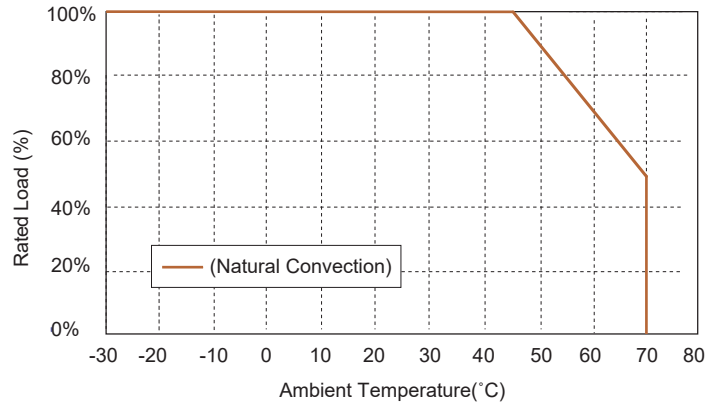

## Specifications

All Specifications Typical At Nominal Line, Full Load, and 25°C Unless Otherwise Noted

### INPUT SPECIFICATIONS

Voltage	90-264Vac, 120-370Vdc
Frequency	47 to 63Hz
Inrush Current	120A max. @240Vac, Cold Start @25°C
Leakage Current	0.25mA max. @ 264Vac
Input Current	100Vac/1.5A max. 240Vac/0.8A max.

### OUTPUT SPECIFICATIONS

Holdup Time	10ms typ. @115Vac
Short Circuit Protection	Hiccup Mode (Auto Recovery)
Temperature Coefficient	±0.05%/°C
Over Voltage Protection	TVS Component to Clamp
Startup time	115Vac <2s typ., 230Vac <1s typ.
Switching Frequency	65KHz Typical

### SAFETY AND EMISSION

Emission and Immunity	EN55032 Class B, FCC Part 15 Class B EN61000-3-2, EN61000-3-3, EN61000-6-3, EN61000-6-4
Immunity	EN55024, EN61204-3, EN61000-6-1, EN61000-6-2
Safety	Class II, IEC/EN/UL 62368-1

### GENERAL SPECIFICATIONS

Isolation Voltage (Input to Output)	3000VAC
Operating Temperature	-30°C-70°C (Derating from 50°C to 70°C)
Storage Temperature	-30°C-85°C
Cooling	Natural Convection
Humidity	93% RH max. Non condensing
Isolation Voltage (Input to Output)	3000VAC
MTBF	MIL-HDBK-217F, GB, 25°C/115VAC 300Khrs min.
Life time	26000 hours min. @ 75% load, 40°C
Dimensions	2.000x2.000x1.346 inches (50.80x50.80x34.20 mm) -E: 2.136x2.136x1.409 inches (54.25x54.25x35.80 mm) -T: 2.700x2.000x1.291 inches (68.58x50.80x32.80 mm)
Weight	93g, 96g(-T), 190g(-E)

### NOTE

- Voltage accuracy is set of 100% rated load.
- Add a 0.1uF ceramic capacitor and a 10uF E.L. capacitor to output for ripple&noise measuring @20MHz BW. (CFM61S050: Add a 0.1uF ceramic capacitor and 47uF E.L. capacitor.)
- Line regulation is measured from high line to low line with full load.
- Load regulation is measured from 10% to 100% full load.
- Typical efficiency at 230 VAC and full load at 25°C.
- T Version wafer with TAIWAN KING PIN TERMINAL PVHI series and mate with JST housing VHR series or equivalent.
- PL(Peak load function) Lasting time < 10 seconds with a maximum 10% duty cycle And must add external 100uF / 400V capacitor to BC+ & BC-

# CFM40D, CFM40T SERIES

## 40 WATT, DUAL / TRIPLE OUTPUTS

### Features

- ◆ Universal Input Range 90-264VAC
- ◆ 2" x 4" Size
- ◆ Industry Standard Pin Out
- ◆ Efficiency to 81%
- ◆ Meets EN61204-3 Class B and CISPR/FCC Class B
- ◆ Short Circuit Protection

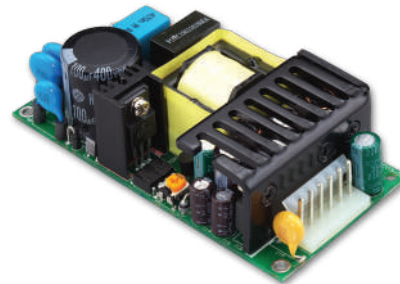

### Mechanical Dimensions

All Dimensions in Inches (mm)  
 Tolerance Inches: X.XXX±0.02  
 Millimeters: X.XX±0.5

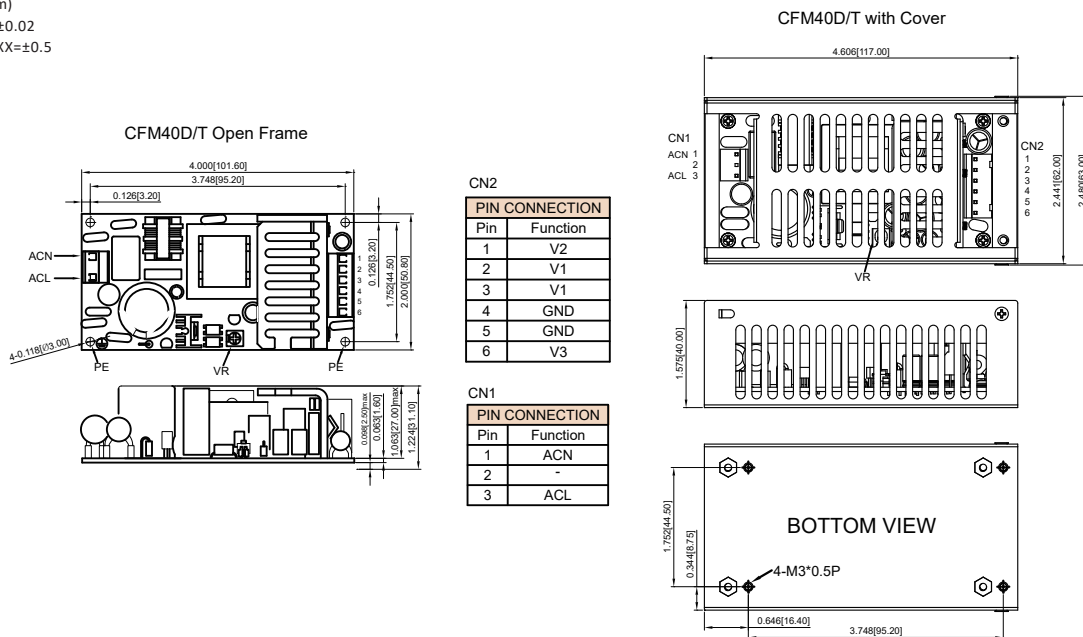

MODEL NUMBER	OUTPUT VOLTAGE	OUTPUT CURRENT			RIPPLE (mVp-p)	VOLTAGE ACCURACY	LINE REG	LOAD REG	O/P POWER MAX.	% EFF. (Typ.)
		MIN.	RATED	MAX.						
CFM40D-01	5V(V1)	0.4	3.2	5.0	50	±3%	±1%	±3%	40.0W	80%
	12V(V2)	0.2	2.0	2.5	120	±4%	±2%	±5%		
CFM40D-02	5V(V1)	0.4	3.2	5.0	50	±3%	±1%	±3%	40.0W	81%
	24V(V2)	0.2	1.0	1.5	240	±4%	±2%	±5%		
CFM40T-01	5V(V1)	0.4	3.0	5.0	50	±3%	±1%	±3%	40.5W	78%
	12V(V2)	0.2	2.0	2.5	120	±4%	±2%	±5%		
	-5V(V3)	0	0.3	0.5	50	±3%	±1%	±1%		
CFM40T-02	5V(V1)	0.4	3.0	5.0	50	±3%	±1%	±3%	42.6W	78%
	12V(V2)	0.2	2.0	2.5	120	±4%	±2%	±5%		
	-12V(V3)	0	0.3	0.5	120	±3%	±1%	±1%		
CFM40T-03	5V(V1)	0.4	3.0	5.0	50	±3%	±1%	±3%	42.0W	78%
	15V(V2)	0.2	1.5	2.3	150	±4%	±2%	±5%		
	-15V(V3)	0	0.3	0.5	150	±3%	±1%	±1%		
CFM40T-04	5V(V1)	0.4	3.0	5.0	50	±3%	±1%	±3%	42.6W	78%
	24V(V2)	0.2	1.0	1.5	240	±4%	±2%	±5%		
	-12V(V3)	0	0.3	0.5	120	±3%	±1%	±1%		
CFM40T-05	5V(V1)	0.4	3.0	5.0	50	±3%	±1%	±3%	40.5W	78%
	24V(V2)	0.2	1.0	1.5	240	±4%	±2%	±5%		
	-5V(V3)	0	0.3	0.5	50	±3%	±1%	±1%		
CFM40T-06	5V(V1)	0.4	3.0	5.0	50	±3%	±1%	±3%	42.6W	78%
	24V(V2)	0.2	1.0	1.5	240	±4%	±2%	±5%		
	12V(V3)	0	0.3	0.5	120	±3%	±1%	±1%		
CFM40T-07	3.3V(V1)	0.4	5.0	7.0	100	±3%	±1%	±3%	30.0W	71%
	5V(V2)	0.2	2.0	3.5	100	±4%	±3%	±5%		
	-12V(V3)	0	0.3	0.5	120	±3%	±1%	±1%		

## Derating Curve

### Open Frame versions

CFM40D-01, 40D-02, 40T-01, 40T-02, 40T-03, 40T-04, 40T-05, 40T-06

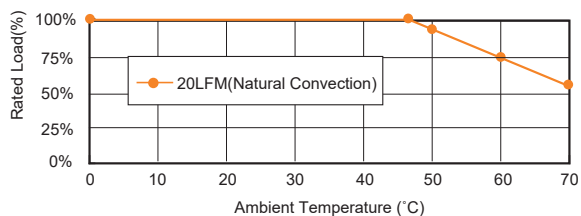

CFM40T-07

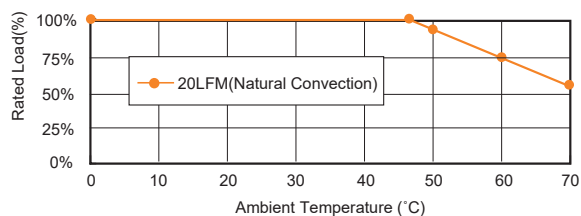

### Covered versions: CFM40D/T-XX-CA

CFM40D-01, 40D-02, 40T-01, 40T-02, 40T-03, 40T-04, 40T-05, 40T-06

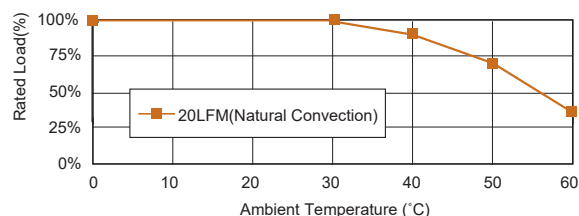

CFM40T-07

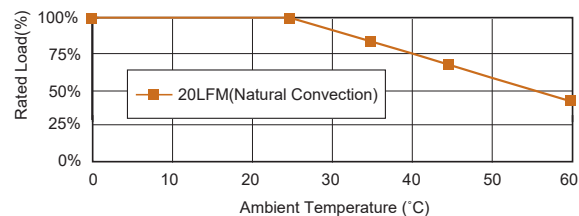

## Specifications

All Specifications Typical At Nominal Line, 75% Load and 25°C Unless Otherwise Noted

### INPUT SPECIFICATIONS

Voltage	90-264Vac, 120-370Vdc
Frequency	47 to 63Hz
Inrush Current	Cold Start@25°C 60A max. @240Vac
Input Current	1A max. (RMS) @115Vac
Leakage Current	3.5mA max.

### OUTPUT SPECIFICATIONS

Rated Power for Convection Cooling	40W (CFM40T-07, 30W)
Maximum Power with 30 CFM Forced Air	50W (CFM40T-07, 40W)
Hold-up Time	20ms typ. @115Vac
Short Circuit	Hiccup Mode (Auto Recover)
Over Voltage Protection CFM40D/T	6V on V1(5V) 16V/20V/30V on V2 (12V/15V/24V)
Over Voltage Protection CFM40T-07	6V on V1 (3.3V), 9V on V2 (5V)
Temperature Coefficient	±0.05%/°C

### SAFETY AND EMISSION

Emission and Immunity	EN55032 Class B, FCC Part 15 Class B, EN61000-6-3, EN61000-3-2, EN61000-3-3 EN55024, EN61204-3, EN61000-6-1
Safety	IEC60950-1, EN60950-1, UL60950-1

### GENERAL SPECIFICATIONS

Isolation		Input to output = 4,242VDC
Operating Temperature		0-70°C (see derating curve)
Storage Temperature		-20-85°C
Humidity		93% RH max. Non-Condensing
Cooling		Natural Convection
Switching Frequency		62.5KHz Typical
MTBF ..... MIL-HDBK-217F, GB, 25°C/115VAC		200Khrs min.
Altitude		2000m
Dimensions		

	Open Frame	4.000 x 2.000 x 1.224 inches (101.60 x 50.80 x 31.10 mm)
	With Cover	4.606 x 2.480 x 1.575 inches (117.00 x 63.00 x 40.00 mm)
Weight	Open Frame	180 g (0.40 Pounds)
	With Cover	220 g (0.49 Pounds)

### NOTE

- Voltage accuracy is set at full load and 25°C Ta.
- Add a 0.1µF ceramic capacitor and a 10µF E.L. capacitor to output for Ripple & Noise measuring @20MHz BW.
- Line regulation is measured from 100Vac to 240Vac with full load.
- Load regulation is measured from 60% to 100% full load and from 60% to 20% full load (60% ±40% full load)
- Input connector mates with Molex housing 09-50-3031 and Molex 2878 series crimp terminal.
- Output connector mates with Molex housing 09-50-3061 and Molex 2878 series crimp terminal.
- Safety approvals do not apply to the covered versions, only to the open-frame versions.

# CFM60T SERIES

## 60 WATT, TRIPLE OUTPUTS

### Features

- ◆ Universal Input: 90-264VAC
- ◆ 2" x 4" Size
- ◆ Industry-Standard Pin Out
- ◆ Efficiency to 83%
- ◆ Meets EN61204-3 Class B and CISPR/FCC Class B
- ◆ Short Circuit Protection



### Mechanical Dimensions

All Dimensions in Inches (mm)  
 Tolerance Inches: X.XXX $\pm$ 0.02  
 Millimeters: X.XX $\pm$ 0.5

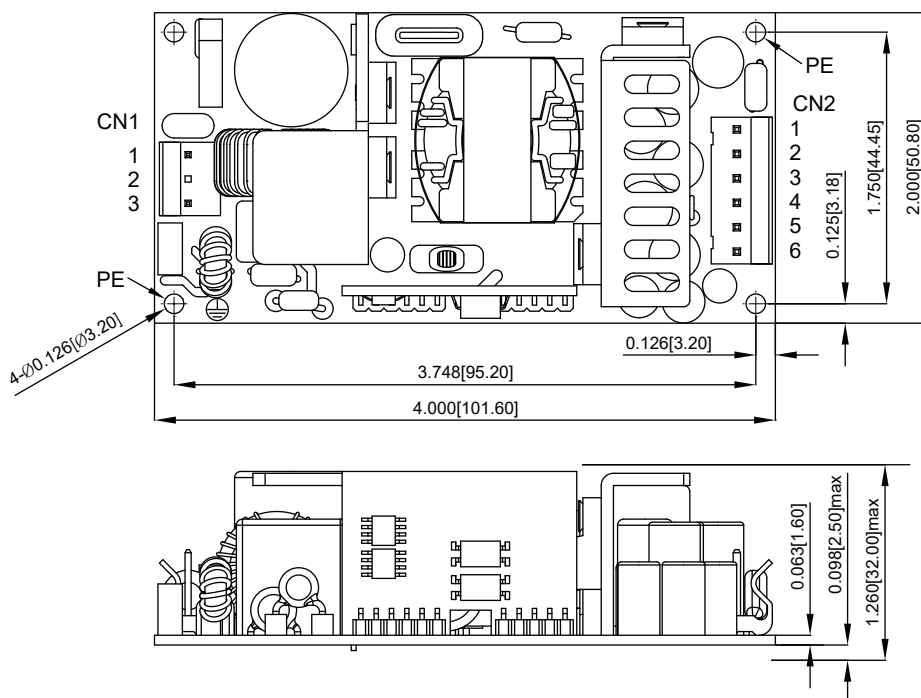

CN1:

PIN CONNECTION	
Pin	Function
1	Neutral
2	Not Fitted
3	Line

CN2:

PIN CONNECTION	
Pin	Function
1	V2
2	V1
3	V1
4	GND
5	GND
6	V3

MODEL NUMBER	OUTPUT VOLTAGE	OUTPUT CURRENT			RIPPLE (mVp-p)	VOLTAGE ACCURACY	LINE REG.	LOAD REG.	O/P POWER MAX.	% EFF. (Typ.)
		MIN.	RATED	MAX.						
CFM60T-01	V1=5 V	0 A	4.0 A	5.0 A	50 mV	$\pm$ 2%	$\pm$ 1%	$\pm$ 4%	62W	83%
	V2=12 V	0 A	3.0 A	3.7 A	120 mV	$\pm$ 5%	$\pm$ 1%	$\pm$ 3%		
	V3=-12 V	0 A	0.5 A	0.65 A	120 mV	$\pm$ 5%	$\pm$ 1%	$\pm$ 5%		
CFM60T-02	V1=5 V	0 A	4.0 A	5.0 A	50 mV	$\pm$ 2%	$\pm$ 1%	$\pm$ 4%	62W	83%
	V2=15 V	0 A	2.5 A	3.1 A	150 mV	$\pm$ 4%	$\pm$ 1%	$\pm$ 3%		
	V3=-15 V	0 A	0.3 A	0.5 A	150 mV	$\pm$ 5%	$\pm$ 1%	$\pm$ 5%		
CFM60T-03	V1=5 V	0 A	4.0 A	5.0 A	50 mV	$\pm$ 2%	$\pm$ 1%	$\pm$ 4%	62W	83%
	V2=24 V	0 A	1.5 A	1.8 A	240 mV	$\pm$ 3%	$\pm$ 1%	$\pm$ 3%		
	V3=-12 V	0 A	0.5 A	0.6 A	120 mV	$\pm$ 5%	$\pm$ 1%	$\pm$ 5%		
CFM60T-04	V1=3.3 V	0 A	6.0 A	7.5 A	50 mV	$\pm$ 4%	$\pm$ 1%	$\pm$ 5%	40.8W	78%
	V2=5 V	0 A	3.0 A	3.7 A	50 mV	$\pm$ 5%	$\pm$ 1%	$\pm$ 4%		
	V3=-12 V	0 A	0.5 A	0.65 A	120 mV	$\pm$ 5%	$\pm$ 2%	$\pm$ 5%		

## Derating Curve

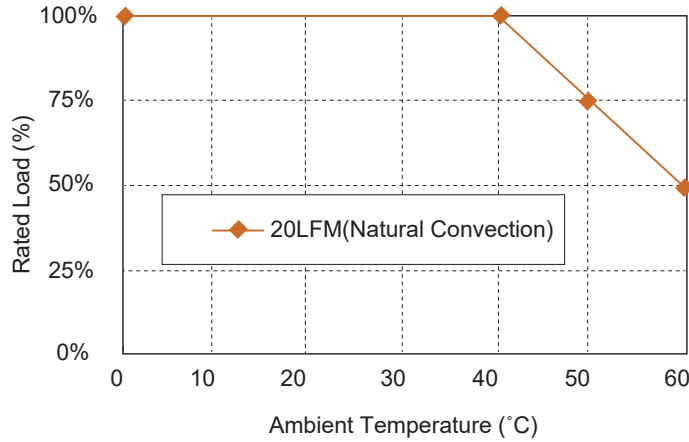

## Specifications

All Specifications Typical At Nominal Line, 75% Load and 25°C Unless Otherwise Noted

### INPUT SPECIFICATIONS

Voltage	90-264Vac, 120-370Vdc
Frequency	47 to 63Hz
Inrush Current	50A max. @240Vac
Leakage Current	3.5mA max.
	Cold Start@25°C

### OUTPUT SPECIFICATIONS

Hold-up Time	8ms typ. @115Vac
Short Circuit	Hiccup Mode (Auto Recover)
Over Voltage Protection	6V/7V on V1(3.3V/5V) 15V/18V/28V on V2 (12V/15V/24V)
Temperature Coefficient	±0.05%/°C

### SAFETY AND EMISSION

Emission and Immunity	EN55032 Class B, FCC Part 15 Class B, EN61000-3-2, EN61000-3-3, EN55024
Safety	IEC60950-1, EN60950-1, UL60950-1

### GENERAL SPECIFICATIONS

Isolation	Input to output = 4,242VDC
Operating Temperature	0-60°C (see derating curve)
Storage Temperature	-20-85°C
Humidity	93% RH max. Non-Condensing
Cooling	Natural Convection
MTBF	MIL-HDBK-217F, GB, 25°C/115VAC 200Khrs min.
Switching Frequency	65KHz Typical
Altitude	2000m
Dimensions	4.000 x 2.000 x 1.260 inches (101.60 x 50.80 x 32.00 mm)
Weight	170 g (0.37 Pounds)

#### NOTE

- Voltage accuracy is set of 60% rated load.
- Add a 0.1µF ceramic capacitor and a 10µF E.L. capacitor to output for ripple & noise measuring @20MHz BW.
- Line regulation is measured from 103VAC-127VAC & 207VAC-253VAC with rated load.
- Load regulation is defined by changing ±40% of measured output load from 60% rated load at other outputs set to 60% rated load.
- Input connector mates with molex housing 09-50-3031 and molex 2878 series crimp terminal.
- Output connector mates with molex housing 09-50-3061 and molex 2878 series crimp terminal.

# CFM80S SERIES

## 80 WATT, 2" X 4" OPEN FRAME

### Features

- ◆ Universal Input Range 90-264VAC
- ◆ Continuous Short Circuit Protection
- ◆ Efficiency to 90% Typical
- ◆ Meets EN55032 Class B and CISPR/FCC Class B
- ◆ Meets EN61000-3-2 Class A
- ◆ No Load Power Consumption < 0.5W
- ◆ 2"x 4" Size

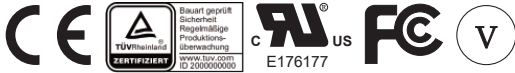

### Mechanical Dimensions

All Dimensions in Inches (mm)  
Tolerance Inches: X.XXX=±0.02  
Millimeters: X.XX=±0.5

CFM80SXXX

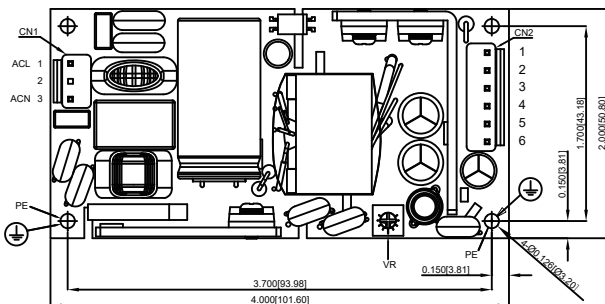

CFM80SXXX-P  
(Input/Output Connector with PIN)

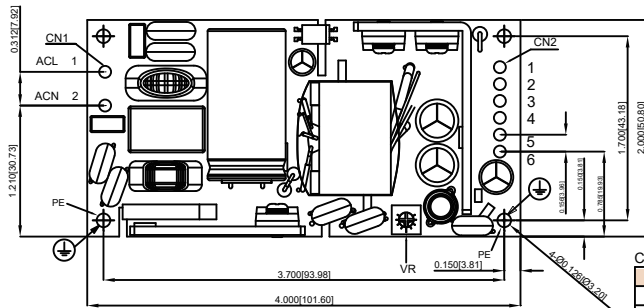

CN1:

PIN CONNECTION	
Pin	Function
1	Line
2	Neutral

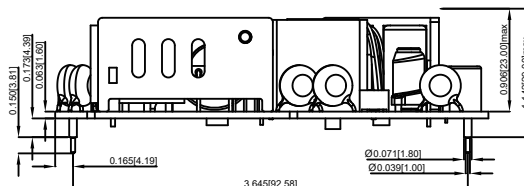
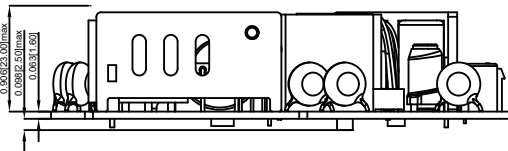

CN2:

PIN CONNECTION	
Pin	Function
1	Vout(+)
2	Vout(+)
3	Vout(+)
4	Vout(-)
5	Vout(-)
6	Vout(-)

MODEL NUMBER	OUTPUT VOLTAGE	OUTPUT CURRENT	RIPPLE & NOISE NOTE 2	VOLTAGE ACCURACY	VOLTAGE ADJ. RANGE NOTE 1	LINE REGULATION NOTE 3	LOAD REGULATION NOTE 4	% EFF (Typ.) NOTE 5
CFM80S050	5 V	12 A	1%	±1%	4.75-5.25 V	±0.5%	±1%	86%
CFM80S120	12 V	6.7 A	1%	±1%	11.4-12.6 V	±0.5%	±1%	89%
CFM80S150	15 V	5.36 A	1%	±1%	14.25-15.75 V	±0.5%	±1%	90%
CFM80S240	24 V	3.35 A	1%	±1%	22.8-25.2 V	±0.5%	±1%	90%
CFM80S480	48 V	1.67 A	1%	±1%	45.6-50.4 V	±0.5%	±1%	90%

## Derating Curve

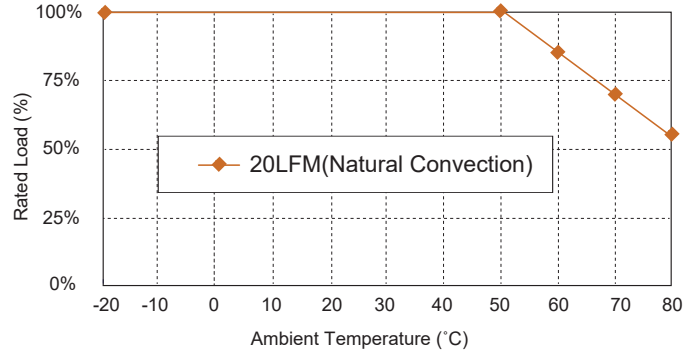

## Specifications

All Specifications Typical At Nominal Line, 75% Load and 25°C Unless Otherwise Noted

### INPUT SPECIFICATIONS

Voltage	90-264Vac, 120-370Vdc
Frequency	47 to 63Hz
Inrush Current	Cold start @25°C 100A max. @240Vac
Input Current	100Vac/1.5A max., 240Vac/0.8A max.
Leakage Current	3.5mA max.

### OUTPUT SPECIFICATIONS

Hold-up Time	12mS typ. @115Vac
Short Circuit Protection	Hiccup Mode (Auto Recover)
Over Voltage Protection	TVS Component to Clamp
Temperature Coefficient	±0.05%/°C

### SAFETY AND EMISSION

Emission and Immunity	EN55032 CLASS B, FCC Part 15 Class B, EN61000-6-3, EN61000-3-2, EN61000-3-3 EN55024, EN61204-3, EN61000-6-1
Safety	Class I, IEC62368-1/60950-1, UL62368-1/60950-1 EN62368-1/60950-1

### GENERAL SPECIFICATIONS

Isolation	Input to output = 3,000VDC
Operating Temperature	-20-80°C (see derating curve)
Storage Temperature	-20°C-85°C
Humidity	93% RH max. Non-Condensing
Cooling	Natural Convection
Switching Frequency	100KHz Typical
Dimensions	4.000 x 2.000 x 1.07 inches (101.6 x 50.8 x 27.1 mm) -P:4.000 x 2.000 x 1.142 inches (101.6 x 50.8 x 29.00 mm)
Weight	155 g

### NOTE

1. Voltage accuracy is set at full load.
2. Add a 0.1µF ceramic capacitor and a 10µF E.L. capacitor to output for ripple & noise measurement @20MHz BW.
3. Line regulation is measured from high line to low line with full load.
4. Load regulation is measured from 10% to 100% full load.
5. Typical efficiency at 230VAC and full load at 25°C.
6. Standard input and output connectors (CN1 and CN2) wafer with TAIWAN KING PIN TERMINAL PVHI series and mate with JST housing VHR series and JST SVH-21/41T-P1.1 series crimp terminal or equivalent.



# CFM81S SERIES

## 80W WATT OPEN FRAME AC-DC MODULES

### Features

- ◆ Universal Input 90-264VAC
- ◆ Continuous Short Circuit Protection
- ◆ High Efficiency up to 90%
- ◆ Meets EN55032 Class B and CISPR/FCC Class B
- ◆ Meets EN60335
- ◆ No load Power <0.3W
- ◆ 2" x 3" Size
- ◆ Peak Load (2 times of rated current (note7))
- ◆ Class I & Class II

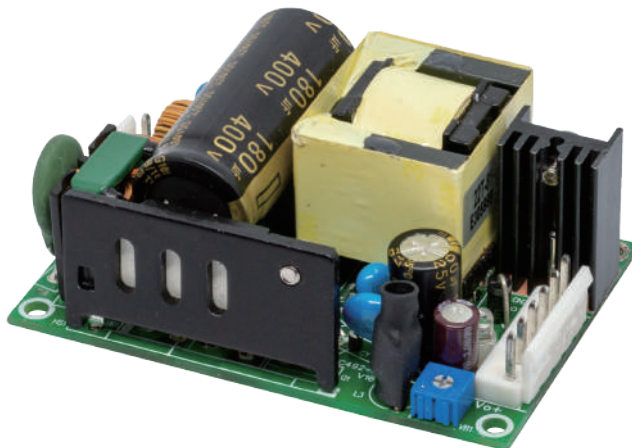

### Mechanical Dimensions

All Dimensions In Inches[mm]  
Tolerance: Inches: x.xxx = ± 0.02  
Millimeters: x.xx = ± 0.5

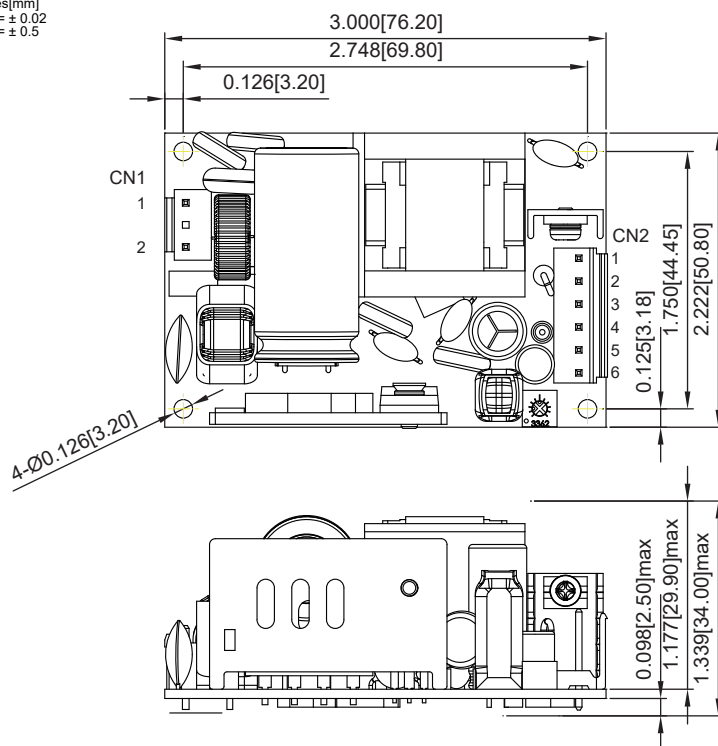

CN1:  
PIN CONNECTION

Pin	Function
1	Line
2	Neutral

CN2:  
PIN CONNECTION

Pin	Function
1	-V Output
2	-V Output
3	-V Output
4	+V Output
5	+V Output
6	+V Output

MODEL NUMBER	OUTPUT VOLTAGE	OUTPUT CURRENT	RIPPLE NOISE (NOTE 2)	VOLTAGE ACCURACY (NOTE 1)	VOLTAGE ADJ. RANGE	LINE REGULATION (NOTE 3)	LOAD REGULATION (NOTE 4)	% EFF. (Typ.) (NOTE 5)
CFM81S120	12 V	6.7 A	1%	±1%	11.4-12.6 V	±0.5%	±1%	89%
CFM81S150	15 V	5.36 A	1%	±1%	14.25-15.75 V	±0.5%	±1%	89%
CFM81S240	24 V	3.35 A	1%	±1%	22.8-25.2 V	±0.5%	±1%	90%
CFM81S480	48 V	1.67 A	1%	±1%	45.6-50.4 V	±0.5%	±1%	90%

## Derating Curve

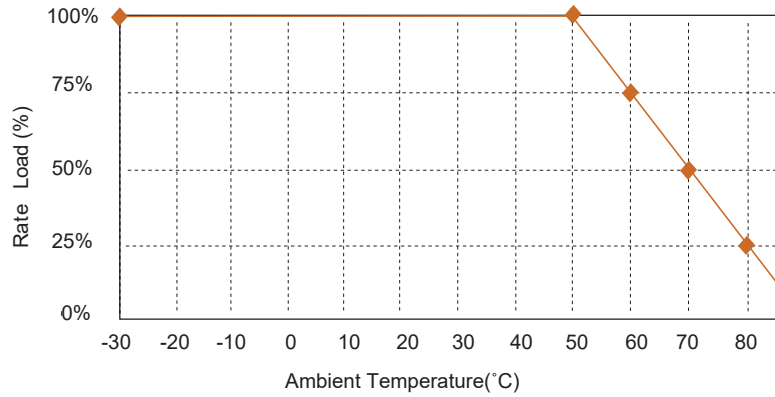

## Specifications

All Specifications Typical At Nominal Line, Full Load, and 25°C Unless Otherwise Noted

### INPUT SPECIFICATIONS

AC Input Voltage	90-264Vac
DC Input Voltage	120-370Vdc
Inrush Current	100A max. @240Vac, Cold Start @25°C
Input Current	100Vac/1.7A max., 240Vac/0.9A max.
Leakage Current	3.5mA max.

### OUTPUT SPECIFICATIONS

Holdup Time	12ms typ. @115Vac
Short Circuit Protection	Hiccup Mode (Auto Recovery)
Over Voltage Protection	TVS Component to Clamp
Temperature Coefficient	±0.05%/°C
Startup time	<2.0s

### SAFETY AND EMISSION

Emission	EN55032 CLASS B, FCC Part 15 Class B EN61000-6-3, EN61000-6-4, EN61000-3-2, EN6100-3-3
Immunity	EN55024, EN61204-3, EN61000-6-1
Safety	IEC62368-1, EN62368-1, UL62368-1

### GENERAL SPECIFICATIONS

Isolation Voltage(Input to Output)	3000VAC
Operating Temperature	-30-85°C (Derating from 50°C to 85°C)
Storage Temperature	-30-85°C
MTBF	MIL-HDBK-217F, GB, 25°C/115VAC 300Khrs max.
Altitude	5000m
Life Time	26000 hours min.@ 75% load, 40°C
Dimensions	2.000x3.000x1.339 inches (50.80x76.20x34.00mm)
Weight	tbd.

### NOTE

1. Voltage accuracy is set at full load.
2. Add a 0.1uF ceramic capacitor and a 10uF E.L. capacitor to output for Ripple & Noise measurement @20MHz BW.
3. Line regulation is measured from high line to low line with full load.
4. Load regulation is measured from 10% to 100% full load.
5. Typical efficiency at 230 VAC and full load at 25°C.
6. Standard input and output connectors (CN1 and CN2) wafer with TAIWAN KING PIN TERMINAL PVHI series and mate with JST housing VHR series and JST SVH-21/41T-P1.1 series crimp terminal
7. PL(Peak load function) Lasting time < 10 seconds with a maximum 10% duty cycle

# CFM101S SERIES

## 100 WATT, 2" X 4" OPEN FRAME

### Features

- ◆ 100W Single Output
- ◆ Universal Input Range 90-264VAC
- ◆ Active PFC Function
- ◆ 2"X4" Size
- ◆ Efficiency at 89% Typical
- ◆ Continuous Short Circuit Protection
- ◆ Meets EN55032 Class B and CISPR/FCC Class B

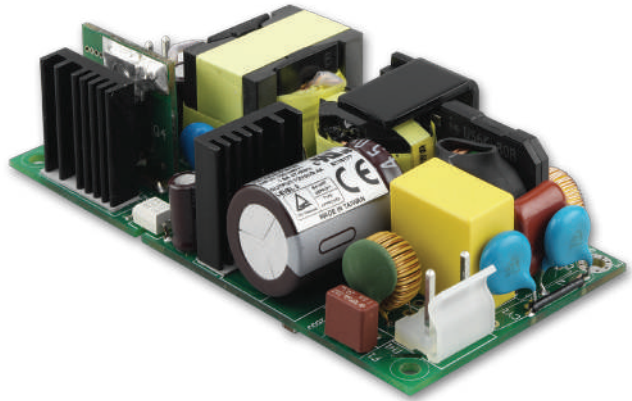

### Mechanical Dimensions

All Dimensions in Inches[mm]  
 Tolerance: Inches:x.xx = ± 0.02 , x.xxx = ± 0.010  
 Millimeters:x.x = ± 0.5 , x.xx = ± 0.25

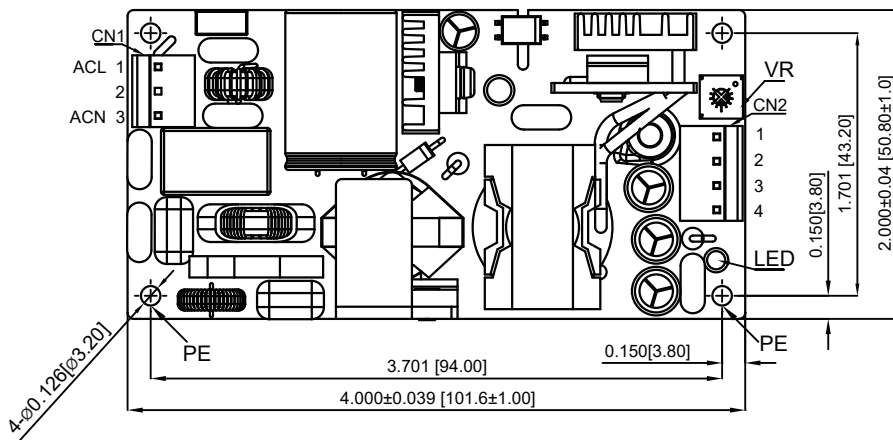

**CN1**

PIN CONNECTION	
Pin	Function
1	Line
2	Not Fitted
3	Neutral

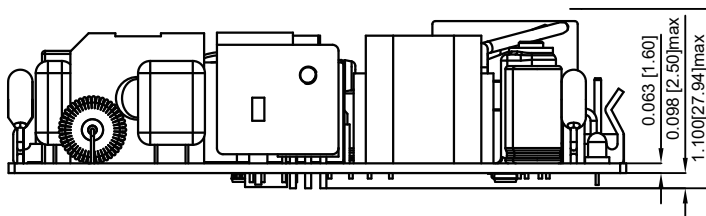

**CN2**

PIN CONNECTION	
Pin	Function
1	Vout(+)
2	Vout(+)
3	Vout(-)
4	Vout(-)

MODEL NUMBER	OUTPUT VOLTAGE	OUTPUT CURRENT	RIPPLE & NOISE (NOTE 1)	VOLTAGE ACCURACY (NOTE 2)	LINE REGULATION (NOTE 3)	VOLTAGE ADJ. RANGE	LOAD REGULATION (NOTE 4)	% EFF (Typ.) (NOTE 5)
CFM101S120	12 V	8.4 A	1%	±1%	±0.5%	11.4-12.6 V	±1%	87%
CFM101S150	15 V	6.7 A	1%	±1%	±0.5%	14.25-15.75 V	±1%	87%
CFM101S200	20 V	5.0 A	1%	±1%	±0.5%	19-21 V	±1%	88%
CFM101S240	24 V	4.2 A	1%	±1%	±0.5%	22.8-25.2 V	±1%	88%
CFM101S480	48 V	2.1 A	1%	±1%	±0.5%	45.6-50.4 V	±1%	89%

## Derating Curve

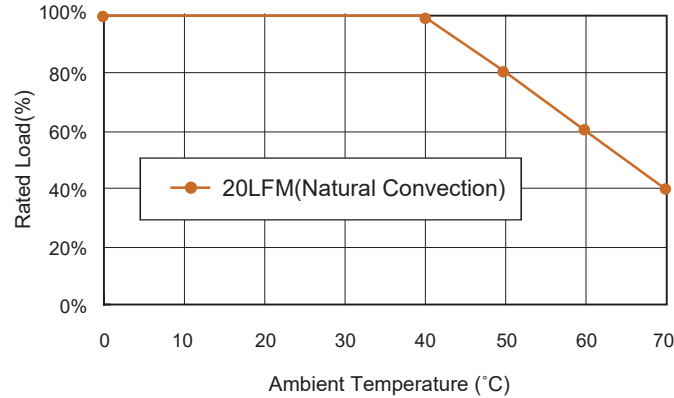

## Specifications

All Specifications Typical At Nominal Line, 75% Load and 25°C Unless Otherwise Noted

### INPUT SPECIFICATIONS

Voltage	90-264Vac, 120-370Vdc
Frequency	47 to 63Hz
Inrush Current	Cold Start @25°C 90A max. @240Vac
Conducted EMI	CISPR/FCC Class B
Leakage Current	3.5mA max.

### OUTPUT SPECIFICATIONS

Hold-up Time	10mS typ. @115Vac
Short Circuit Protection	Continuous
Over Voltage Protection	TVS Component to Clamp
Temperature Coefficient	±0.05%/°C

### SAFETY AND EMISSION

Emission and Immunity	EN55032 Class B FCC Part 15 Subpart B Class B, EN55024, EN61204-3, EN61000-6-3, EN61000-6-1, EN61000-3-2, EN61000-3-3
Safety	Class I, IEC60950-1, EN60950-1, UL60950-1

### GENERAL SPECIFICATIONS

Isolation	Input to output= 4,242VDC
Operating Temperature	0-70°C (see derating curve)
Storage Temperature	-20-85°C
Humidity	93% RH max. Non condensing
Cooling	Natural Convection
Switching Frequency	100KHz Typical
MTBF ..... MIL-HDBK-217F, GB, at 25°C/115VAC	200Khrs min.
Altitude	2000m
Dimensions	102.6 x 50.8 x 27.94 mm (4.100 x 2.000 x 1.100 inches)
Weight	150 g

### NOTE

1. Add a 0.1µF ceramic capacitor and a 10µF E.L. capacitor to output for ripple & noise measurement @20MHz BW.
2. Voltage accuracy is set at 100% full load.
3. Line regulation is measured from high line to low line with full load.
4. Load regulation is measured from 10% to 100% full load.
5. Typical efficiency at 230VAC and full load at 25°C.
6. Input connector mates with molex housing 09-50-3031 and molex 2878 series crimp terminal.
7. Output connector mates with molex housing 09-50-3041 and molex 2878 series crimp terminal.

# CFM150S SERIES

## 150 WATT I.T.E AC-DC POWER SUPPLY

### Features

- ◆ Universal Input 90-264VAC
- ◆ 2" x 4" Open Frame Compact Size
- ◆ 120W with Natural Convection
- ◆ 150W with Base Cooling
- ◆ No Load Input Power Consumption < 150mW
- ◆ Active PFC Function
- ◆ High Efficiency up to 94%
- ◆ Continuous Short Circuit Protection
- ◆ Meets IEC/EN60335-1
- ◆ EMI Safety Meets Class I & Class II
- ◆ Operating Altitude 5000m



### Ordering information

CFM150SXXX - X  
Blank: Wafer  
B: Base Cooling

PRELIMINARY

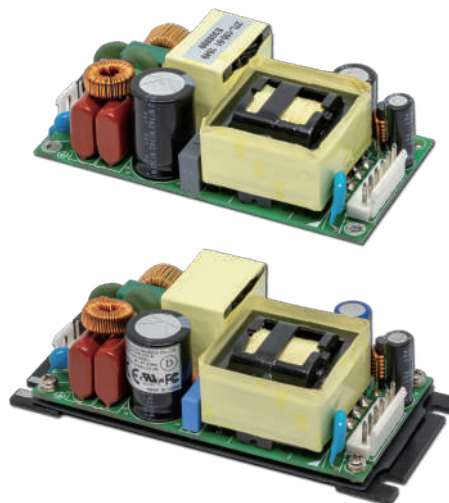

### Mechanical Dimensions

All Dimensions In Inches[mm]  
Tolerance: Inches: x.xxx = ± 0.02  
Millimeters: x.xx = ± 0.5

CFM150SXXX

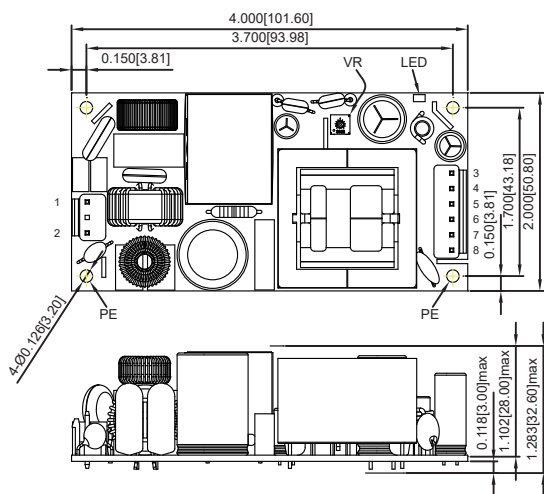

CFM150SXXX-B

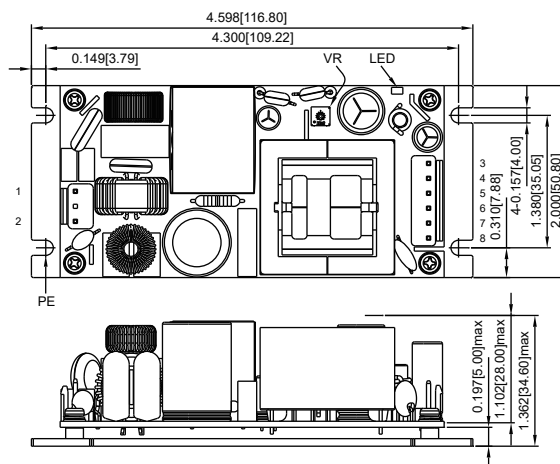

Pin	Function
1	ACL
2	ACN
3	V+
4	V+
5	V+
6	V-
7	V-
8	V-

MODEL NUMBER	OUTPUT VOLTAGE	OUTPUT CURRENT		RIPPLE NOISE (NOTE 2)	VOLTAGE ACCURACY (NOTE 1)	VOLTAGE ADJ. RANGE	LINE REGULATION (NOTE 3)	LOAD REGULATION (NOTE 4)	% EFF. (Typ.) (NOTE 5)
		Natural Convection	Base Cooling						
CFM150S120	12 V	10.0 A	12.5 A	1%	±1%	±8%	±0.5%	±1%	93%
CFM150S240	24 V	5.0 A	6.25 A	1%	±1%	±8%	±0.5%	±1%	94%
CFM150S280	28 V	4.28 A	5.35 A	1%	±1%	±8%	±0.5%	±1%	94%
CFM150S360	36 V	3.33 A	4.16 A	1%	±1%	±8%	±0.5%	±1%	94%
CFM150S480	48 V	2.5 A	3.125 A	1%	±1%	±8%	±0.5%	±1%	94%

## Derating Curve

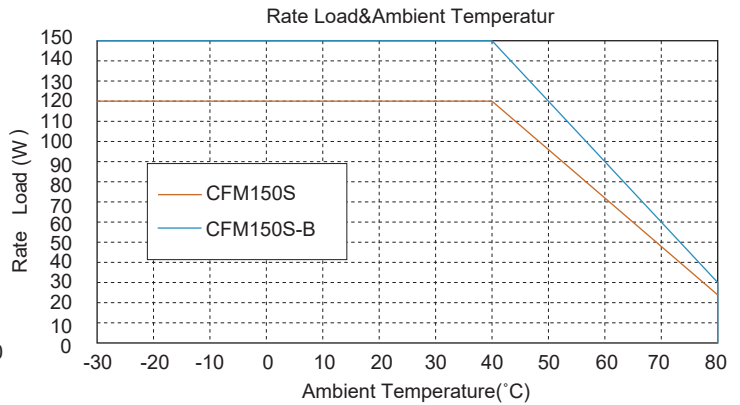
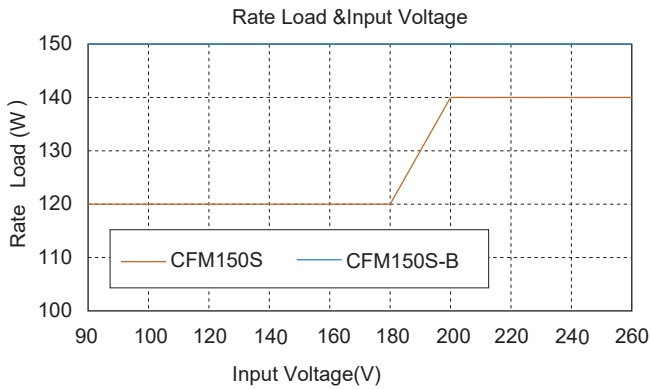

## Specifications

All Specifications Typical At Nominal Line, Full Load, and 25°C Unless Otherwise Noted

### INPUT SPECIFICATIONS

Voltage	90-264Vac
Frequency	47 to 63Hz
Inrush Current	Cold start @25°C 100A max. @240Vac
Input Current	100Vac/2A max., 240Vac/0.8Amax.
Leakage Current	100uA max.

### OUTPUT SPECIFICATIONS

Holdup Time	25mS typ.20mS min. @115Vac
Short Circuit Protection	Hiccup Mode (Auto Recovery)
Over Voltage Protection	Latch
Temperature Coefficient	±0.05%/°C

### SAFETY AND EMISSION

Emission	EN55032 CLASS B, FCC Part 15 Class B EN61000-3-2, EN61000-3-3, EN61000-6-3, EN61000-6-4
Immunity	EN55024, EN61204-3, EN61000-6-1, EN61000-6-2
Safety	Class I & Class II, IEC/EN/UL62368-1

### GENERAL SPECIFICATIONS

Isolation	Input to output = 3,000VAC
Operating Temperature	-30 -80°C (see derating curve) -40°C can be Start-Up
Storage Temperature	-40 -85°C
MTBF	MIL-HDBK-217F, GB, 25°C/115VAC T.B.D 5000m
Altitude	26000 hours min.@ 75% load, 40°C
Life Time	4.00x2.00x1.283 inches (101.6x50.8x32.6mm)
Dimensions	-B:4.598x2.00x1.362 inches (116.8x50.8x34.6mm) CFM150SXXX 200g CFM150SXXX-B 240g
Weight	

### NOTE

1. Voltage accuracy is set at full load.
2. Add a 0.1uF ceramic capacitor and a 10uF E.L. capacitor to output for Ripple & Noise measuring @20MHz BW.
3. Line regulation is measured from 100Vac to 240Vac with full load.
4. Load regulation is measured from 10% to 100% full load.
5. Typical efficiency at 230 VAC and full load at 25°C.
6. Standard input and output connectors (CN1 and CN2) wafer with TAIWAN KING PIN TERMINAL PVHI series and mate with JST

# CFM201S SERIES

## 200 WATT, 3" X 5" OPEN FRAME

### Features

- ◆ Universal Input Range 90-264VAC
- ◆ Active PFC Meets EN61000-3-2
- ◆ Conductive EMI Meets CISPR/FCC Class B
- ◆ High Efficiency up to 92%
- ◆ Remote Voltage Sense
- ◆ Over Temperature Protection



### Mechanical Dimensions

All Dimensions in Inches (mm)  
 Tolerance Inches: X.XXX=±0.02  
 Millimeters: X.XX=±0.5

#### Open Frame

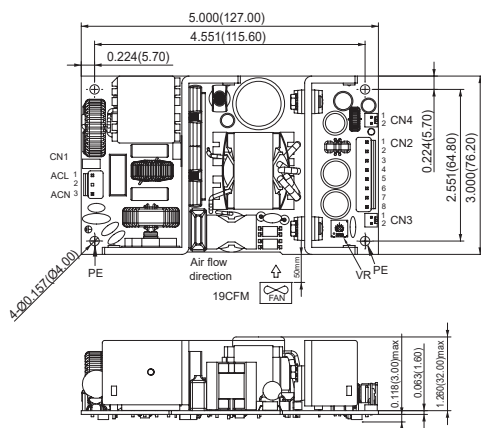

#### With Cover

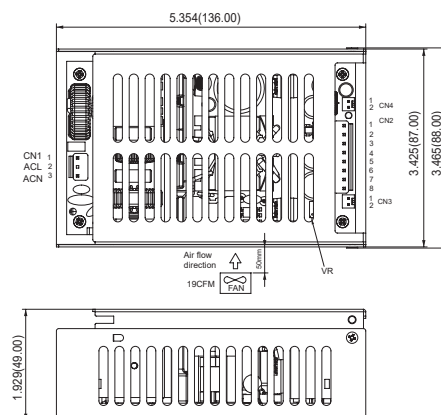

CN1:

PIN CONNECTION	
Pin	Function
1	ACL
2	-
3	ACN

CN2:

PIN CONNECTION			
Pin	Function	Pin	Function
1	Vout(+)	5	Vout(-)
2	Vout(+)	6	Vout(-)
3	Vout(+)	7	Vout(-)
4	Vout(+)	8	Vout(-)

CN3:

PIN CONNECTION	
Pin	Function
1	Rs+
2	Rs-

CN4:

PIN CONNECTION	
Pin	Function
1	FAN V+
2	FAN V-

MODEL NUMBER	OUTPUT VOLTAGE	OUTPUT CURRENT RATED 1	OUTPUT CURRENT RATED 2	RIPPLE & NOISE (NOTE 1)	VOLTAGE ACCURACY (NOTE 2)	LINE REGULATION (NOTE 3)	VOLTAGE ADJ. (RANGE)	LOAD REGULATION (NOTE 4)	% EFF. (Typ.) (NOTE 5)
<b>Main Output Voltage</b>									
CFM201S120	+12 V	16.67 A	12.5 A	120 mV	± 1%	± 0.5%	11.4-12.6	± 1%	89%
CFM201S240	+24 V	8.34 A	6.25 A	150 mV	± 1%	± 0.5%	22.8-25.2	± 1%	90%
CFM201S360	+36 V	5.56 A	4.17 A	150 mV	± 1%	± 0.5%	34.2-37.8	± 1%	91%
CFM201S480	+48 V	4.17 A	3.13 A	150 mV	± 1%	± 0.5%	45.6-50.4	± 1%	92%
<b>Fan Output Voltage</b>									
All	+12 V	0.5 A		120 mV	± 3%	± 1%	--	± 5%	--



## Derating Curve

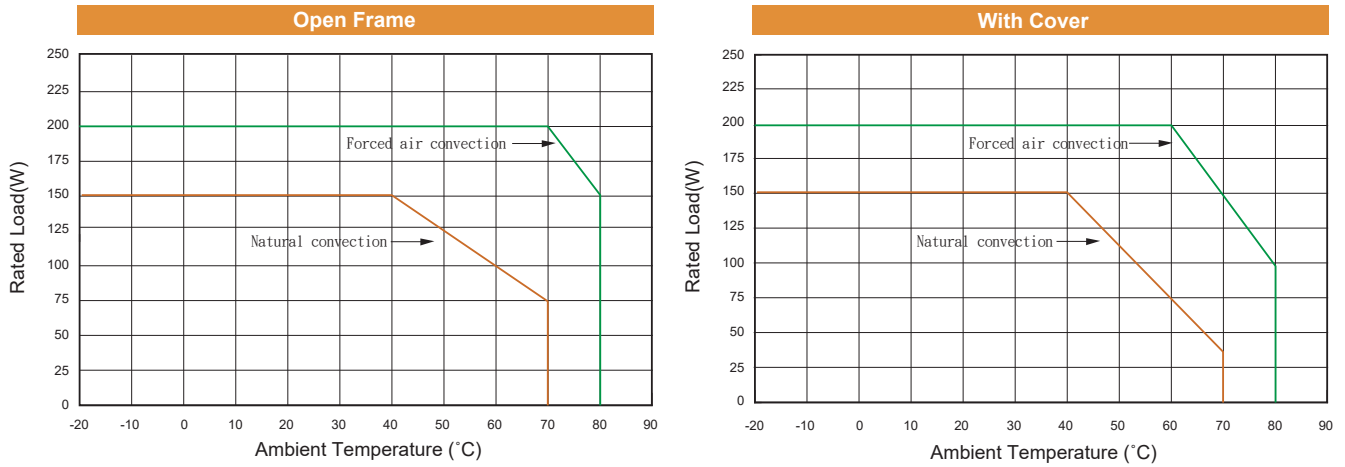

## Specifications

All Specifications Typical At Nominal Line, 75% Load and 25°C Unless Otherwise Noted

### INPUT SPECIFICATIONS

AC Input Voltage	90-264Vac, 120-370Vdc
Input current	100Vac/3A max., 240Vac/1.5A max.
Frequency	47 to 63Hz
Inrush Current	Cold Start@25°C 100A max. @240Vac
EMI	CISPR/FCC Class B
Leakage Current	3.5mA max.

### OUTPUT SPECIFICATIONS

Isolation	Input to Output = 3000VAC (4,242VDC)
Hold-up Time	10ms typ@115Vac
Over Voltage Protection	Hiccup mode (Auto Recovery)
Short Circuit Protection	Hiccup mode (Auto Recovery)
Temperature Coefficient	±0.05%/°C

### SAFETY AND EMISSION

Emission and Immunity	EN55032 Class B, FCC Part15 Class B, EN61000-6-3, EN61000-3-2, EN61000-3-3 EN55024, EN61000-6-1, EN61204-3
Safety	IEC60950-1, EN60950-1, UL60950-1 2 <sup>nd</sup> edition

### GENERAL SPECIFICATIONS

Operating Temperature	-20-80°C (see derating curve)
Storage Temperature	-20-85°C
Over Temperature Protection	Auto Recovery
Humidity	93% RH max. non-condensing
Altitude	2000m
Cooling	Natural convection for 150W and forced air convection (19CFM FAN) for 200W
Switching Frequency	80-100kHz typ.
MTBF	MIL-HDBK-217F, GB, 25 °C/115VAC 120Khrs typ.
Dimensions	
Open frame	5.000 x 3.000 x 1.441 inches (127.00 x 76.20 x 36.60mm)
With Cover	5.354 x 3.465 x 1.929 inches (136.00 x 88.00 x 49.00 mm)
Weight	Open frame 400 g With Cover 500 g

### NOTE

- Add a 0.1µF ceramic capacitor and a 10µF E.L. capacitor to output for ripple & noise measuring @20MHz BW
- Voltage accuracy is set at 60% rated load and 25°C.Ta.
- Line regulation is measured from high line to low line with rated load.
- Load regulation is measured from full to 10% load.
- Typical efficiency at 230VAC and full load at 25°C.
- Standard input and output connectors (CN1 and CN2) wafer with TAIWAN KING PIN TERMINAL PVHI series and mate with JST housing VHR series or equivalent.
- Optional Input and output connectors (CN1 and CN2) wafer with LONG CHU P3060 series and mate with MOLEX housing 5195 series or equivalent.
- Output connector CN3 (Remote voltage sense) mates with molex housing 5051 or equivalent.
- Output connector CN4 (Fan output) mates with MOLEX housing 5051 or equivalent.
- For covered versions add "C" to model number or order part no.  
For example CFM201S120-C, safety approvals do not the covered assembly, only to the open-frame power supply.

# CFM260S SERIES

## 260 WATT AC-DC POWER SUPPLY WITH PFC

### Features

- ◆ Universal Input Range 85-264Vac
- ◆ 2"x 4" Compact Size @CFM260SXXX
- ◆ Active PFC Meets EN61000-3-2
- ◆ EN62368 and EN55032 (Class B Conducted)
- ◆ Complies EN61558-1 and IEC/EN60335-1
- ◆ No Load Power Consumption<0.15W @AC230V
- ◆ IEC Protection Design Meet Class I and Class II
- ◆ High Efficiency up to 93% Typical
- ◆ 12V Fan Output

### Ordering information

CFM260SXXX  
Model No.

X  
Blank: WAFER  
B: Base Cooling  
C: With Cover

PRELIMINARY

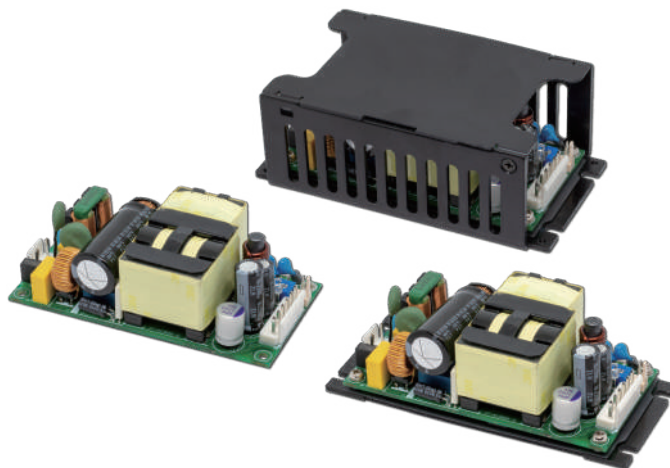

### Mechanical Dimensions

All Dimensions In Inches[mm]  
Tolerance: inches: x.xxx = ± 0.02  
Millimeters: x.xx = ± 0.5

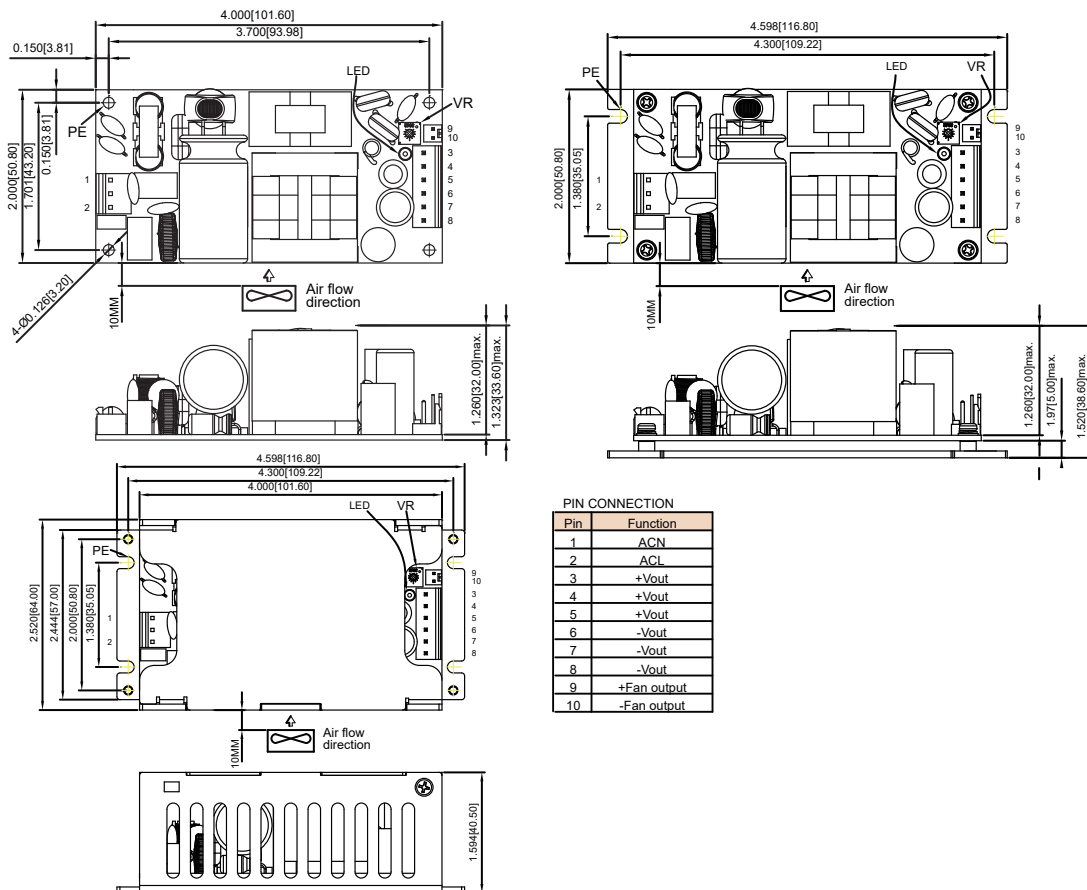

MODEL NUMBER	VOLTAGE OUTPUT	OUTPUT CURRENT			RIPPLE NOISE (NOTE 4)	VOLTAGE ACCURACY (NOTE 5)	VOLTAGE ADJ. RANGE	LINE REGULATION (NOTE 6)	LOAD REGULATION (NOTE 7)	% EFF. (Typ.) (NOTE 8)
		RATED1 (NOTE 1)	RATED2 (NOTE 2)	RATED2 (NOTE 2)						
Main Output Voltage										
CFM260S120	+12 V	10.84 A	14.17 A	21.67 A	120mVp-p	±1%	±5%	±0.5%	±1%	92%
CFM260S240	+24 V	5.42 A	7.08 A	10.83 A	240mVp-p	±1%	±5%	±0.5%	±1%	93%
CFM260S360	+36 V	3.61 A	4.72 A	7.22 A	240mVp-p	±1%	±5%	±0.5%	±1%	93%
CFM260S480	+48 V	2.71 A	3.55 A	5.42 A	480mVp-p	±1%	±5%	±0.5%	±1%	93%
Fan Output Voltage										
ALL	+12 V	0.3 A	0.3 A	0.3 A	—	—	—	—	—	—

## Derating Curve

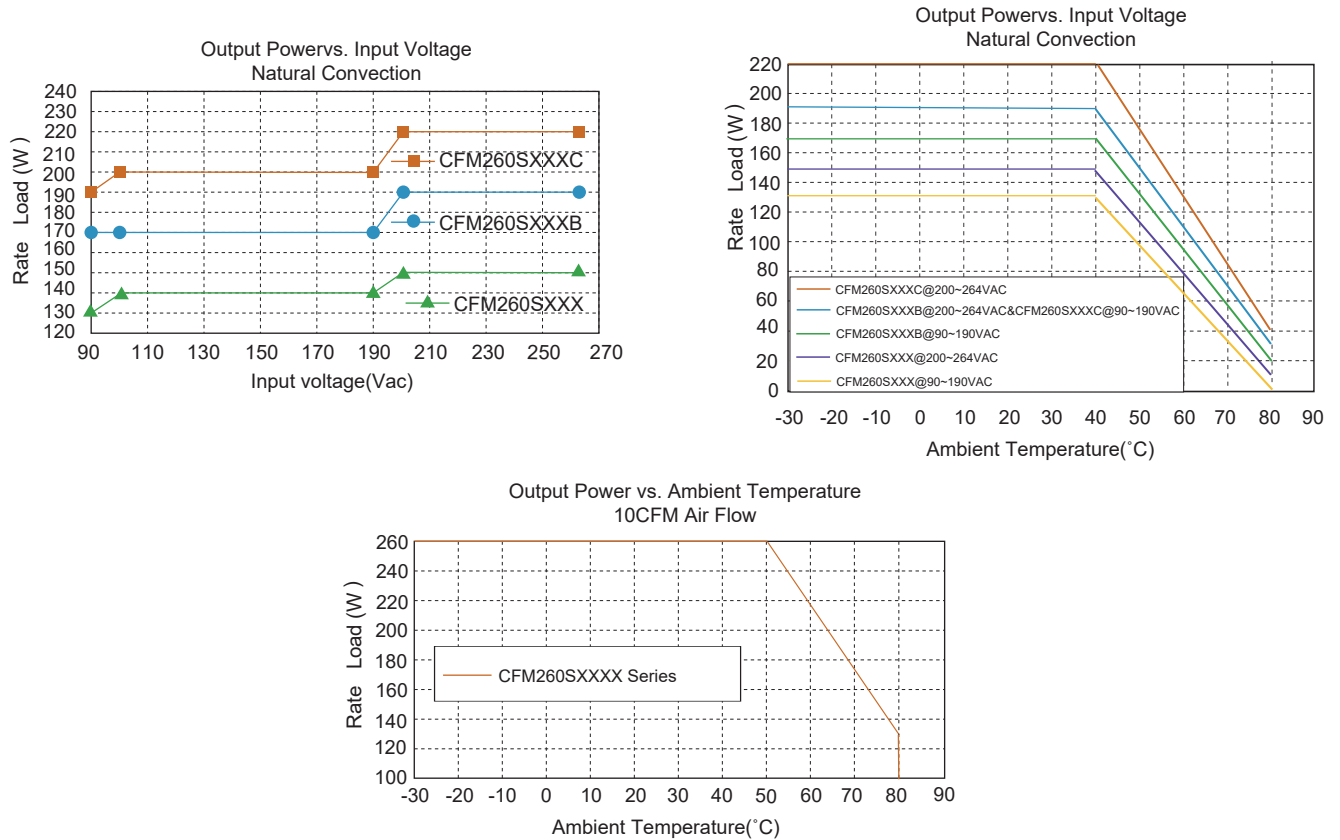

## Specifications

All Specifications Typical At Nominal Line, Full Load, and 25°C Unless Otherwise Noted

### INPUT SPECIFICATIONS

AC Input Voltage	85-264Vac
Frequency	47 to 63Hz
Inrush Current	100A max. @230Vac, 25°C cold start
Leakage Current	0.1mA max.

### OUTPUT SPECIFICATIONS

Holdup Time	20mS typ. @115Vac
Short Circuit Protection	Hiccup Mode (Auto Recovery)
Over Voltage Protection	Recycle AC input to restart
Temperature Coefficient	±0.03%/°C

### SAFETY AND EMC

Emission and Immunity	EN55032 Class B Conducted and Radiated (EN61000-3-2, EN 61000-3-3), EN55024 (EN61204-3, EN61000-6-1, IEC61000-4-2, IEC61000-4-3, IEC61000-4-4, IEC61000-4-5) IEC62368, EN62368, UL62368 IEC/EN61558-1, EN61558-2-16, IEC/EN60335-1
Safety	
Complies with	

### GENERAL SPECIFICATIONS

Isolation	Input to output = 3000VAC
Operating Temperature	-30 - 80°C (see derating curve) -40°C can be Start-Up
Storage Temperature	-40-85°C
Humidity	93% RH max. Non condensing
Switching Frequency	100KHz Typical
MTBF	MIL-HDBK-217F, GB, 25°C/115VAC >300Khrs typ.
Altitude	5000m (Note 9)
Dimensions	
Open frame versions	4.00x2.00x1.323 inches (101.6x50.8x33.6mm)
Baseplate versions	4.598x2.00x1.520 inches (116.8x50.8x38.6mm)
Covered versions	4.598x2.52x1.594 inches (116.8x64.0x40.5mm)
Weight	
Open frame versions	230 g (0.507 Pounds)
Baseplate versions	276 g (0.608 Pounds)
Covered versions	332 g (0.732 Pounds)

### NOTE

- 1.RATED1: Natural Convection without Baseplate. (CFM260SXXX).
- 2.RATED2: Natural Convection with Baseplate. (CFM260SXXXB)
- 3.RATED3: Forced air Convection.
- 4.Add a 0.1uF ceramic capacitor and a 10uF E.L. capacitor to output for Ripple & Noise measuring @20MHz BW.
- 5.Voltage accuracy is set at 60% rated load and 25°C Ta.
- 6.Line regulation is measured from High Line to Low Line with rated load.
- 7.Load regulation is measured from full to 10% rated.
- 8.Typical efficiency at 230 VAC and full load at 25°C.
- 9.Safety - (EN61558-1) altitude of 3000 meters.
- 10.Input and Output connectors (CN1&CN2) wafer with TAIWAN KING PIN TERMINAL PVHI series and mate with JST Housing VHR series or equivalent.
- 11.Fan output connector(CN3) wafer with Chyao shiunn JS-6001 series and mate with Chyao shiunn Housing JS-8001 series or equivalent.

# CFM300S SERIES

## 300 WATT AC-DC POWER SUPPLY WITH PFC

### Features

- ◆ Universal Input Range 90-264Vac
- ◆ Active PFC Meets EN61000-3-2 Class C&D
- ◆ High Efficiency up to 94%
- ◆ High Power Density up to 14.1W/Inch<sup>3</sup>
- ◆ Meets EN55032 Class B and CISPR/FCC CLASS B
- ◆ Over Temperature Protection
- ◆ Continuous Short Circuit Protection
- ◆ Remote Voltage Sense
- ◆ PS On/Off Remote Control
- ◆ Power Good & Power Fail Signal
- ◆ +5V Stand-by Output Power
- ◆ 12V Fan Output
- ◆ No Load Power Consumption<0.3W NOTE6
- ◆ 3"x 5" Size

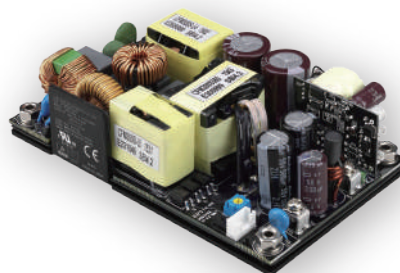

### Mechanical Dimensions

All Dimensions in Inches[mm]  
Tolerance Inches:x.xxx±0.02  
Millimeters:x.xx±0.5

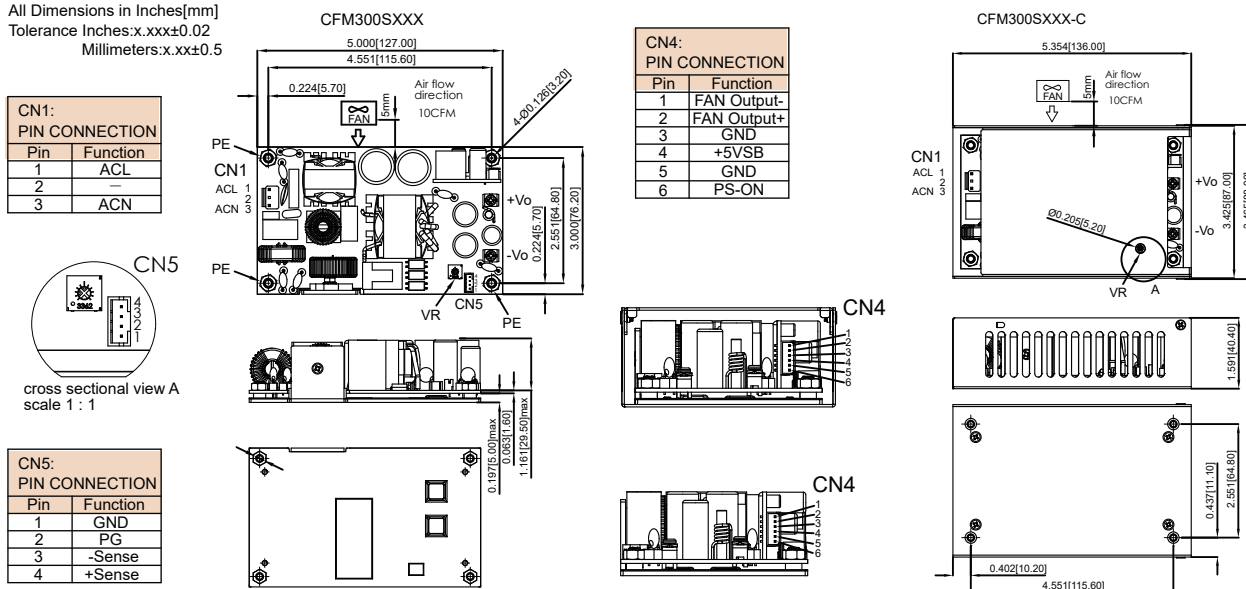

MODEL	OUTPUT VOLTAGE	OUTPUT CURRENT		RIPPLE (mVp-p) (NOTE 1)	VOLTAGE ACCURACY (NOTE 2)	LINE REGULATION (NOTE 3)	Voltage ADJ. Rang	LOAD REGULATION (NOTE 4)	%EFF Typ. (NOTE 5)
		Rated1	Rated2						
<b>Main Output Voltage</b>									
CFM300S120	±12 V	25 A	16.67 A	120mV	±1%	±0.5%	11.4~12.6	±1%	92.5%
CFM300S240	±24 V	12.5 A	8.34 A	150mV	±1%	±0.5%	22.8~25.2	±1%	93.5%
CFM300S360	±36 V	8.34 A	5.65 A	150mV	±1%	±0.5%	34.2~37.8	±1%	93.5%
CFM300S480	±48 V	6.25 A	4.17 A	150mV	±1%	±0.5%	45.6~50.4	±1%	94.0%
<b>Stand-by Output Voltage</b>									
All	+5 V	1 A	0.6 A	100mV	±3%	±1%	--	±5%	--
<b>Fan Output Voltage</b>									
All	+12 V	0.5 A	0.5 A	--	--	--	--	--	--

Note:  
Rated 1: Forced Air Convection  
Rated 2: Natural Convection  
For Covered Versions Add "C" to Model Number or Order Part No. For example CFM300S120C

## Derating Curve

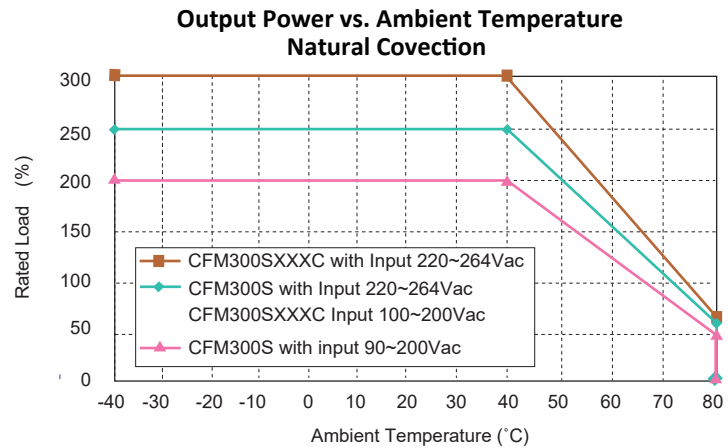
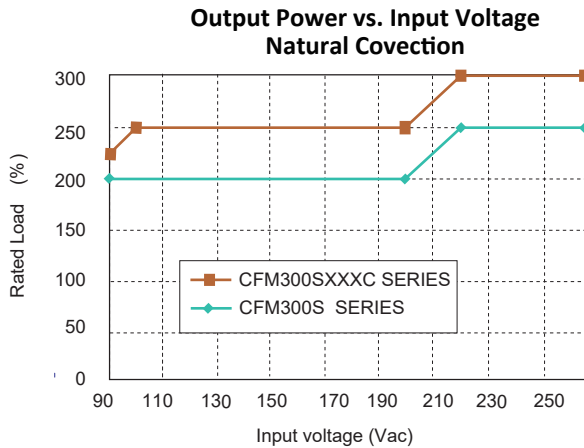

## Specifications

All Specifications Typical At Nominal Line, Full Load, and 25°C Unless Otherwise Noted

### INPUT SPECIFICATIONS

Input Voltage	90-264Vac, 120-370Vdc
Input Current	100Vac/4A max., 240Vac/1.8A max.
Frequency	47 to 63Hz
Inrush Current	Cold start@25°C 30A max. @240Vac
Leakage Current	260uA typ., 3.5mA max.

### OUTPUT SPECIFICATIONS

Isolation	Input to Output = 3000VAC.
Hold-up Time	20ms typ. @115Vac
Over Voltage Protection	Latch off
Short Circuit Protection	Hiccup mode(Auto Recovery)
Temperature Coefficient	±0.05%/°C

### SAFETY AND EMISSION

Emission and Immunity	EN55032 CLASS B ,EN55024 EN61000-3-2, EN61000-3-3 FCC CFR 47 Part 15 Subpart B IEC61000-2, IEC61000-3 IEC61000-4, IEC61000-5 IEC61000-6, IEC61000-8, IEC61000-11
Safety	Class I, IEC60950-1, EN60950-1 UL60950-1 2 <sup>nd</sup> edition

### GENERAL SPECIFICATIONS

Operating Temperature	-40~80°C (see derating curve)
Storage Temperature	-40~85°C
Over Temperature Protection	Auto Recovery
PS-On Signal	Power On: PS-On ≤ 2V (note 12) Power Off: PS-ON=11-16V, Open Circuit
Power Good/Power Fail(PG)	250ms>PG>50ms The TTL goes high with 50ms to 250ms after power set up The TTL goes low at least 5ms before Vo below 90% rated value
Humidity	93% RH max. Non-Condensing
Altitude	5000m
Cooling	Natural convection for 200W-250W(see derating curve) Forced Air Flow Convection(10CFM) for 300W
Switching Frequency	60-80KHz typ. @ Full load
MTBF	160Khrs. typ.
MIL-HDBK-217F, GB, 25°C/115VAC	
Dimensions	
Open Frame Versions	5.000 x 3.000 x 1.421 Inches (127.00x76.20x36.1mm)
-C Covered Versions	5.355 x 3.425 x 1.591 Inches (136.00x87.00x40.40mm)
Weight	
Open Frame Versions	420g (0.925 Pounds)
-C Covered Versions	550g (1.21 Pounds)

### NOTE

- Add a 0.1uF ceramic capacitor and a 10uF E.L. capacitor to output for ripple&noise measuring @20MHz BW.
- Voltage accuracy is set at 100% rated load and 25°C.Ta.
- Line regulation is measured from High Line to Low Line with rated load.
- Load regulation is measured from Full to 10% load.
- Typical efficiency at 230 VAC and full load at 25°C.
- No load power consumption<0.3W by PS on/off remote control.
- Input connector (CN1) wafer with TAIWAN KING PIN TERMINAL PVHI series and mate with JST housing VHR series or equivalent.
- Optional Input connector (CN1) wafer with LONG CHU P3060 series and mate with MOLEX housing 5195 series or equivalent.
- Output connector CN4 wafer with JST PH series and mate with JST housing PH series or equivalent.
- Output connector CN5 wafer with TAIWAN KING PIN TERMINAL P110I series and mate with JST housing PH series or equivalent.
- Output connectors (Vo+ & Vo- with M3 screw) mate with round terminal, and round terminal of the max outer diameter is 6.75mm, max inner diameter is 3.9mm.
- PS-ON and GND short, IPS-ON =4.5 mA typical.

# CFM361S SERIES

## 360 WATT, 3" X 5" WITH PFC

### Features

- ◆ Universal Input Range 90-264VAC
- ◆ 3"x 5" Compact Size/CFM361S
- ◆ 300W with Natural Convection @ 220Vac/CFM361S
- ◆ 360W with Natural Convection @ 220Vac/CFM361SXXXC
- ◆ 360W with Baseplate Cooled -40-85°C/CFM361SXXXC
- ◆ Meets EN60950 and EN55022 Class B
- ◆ Active PFC Meets EN61000-3-2
- ◆ High Efficiency up to 93.5% Typical
- ◆ High Power Density up to 15W/inch<sup>3</sup> /CFM361S
- ◆ Remote Voltage Sense
- ◆ PS On/Off Remote Control
- ◆ +5V Stand-by Output Power
- ◆ 12V Fan Output
- ◆ Structure Patented

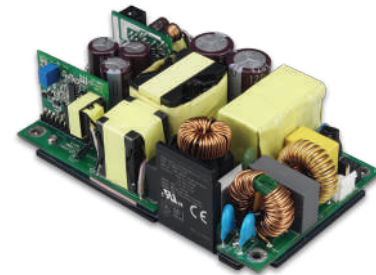

### Mechanical Dimensions

All Dimensions in Inches (mm)  
Tolerance Inches: X.XXX=±0.02  
Millimeters: X.XX=±0.5

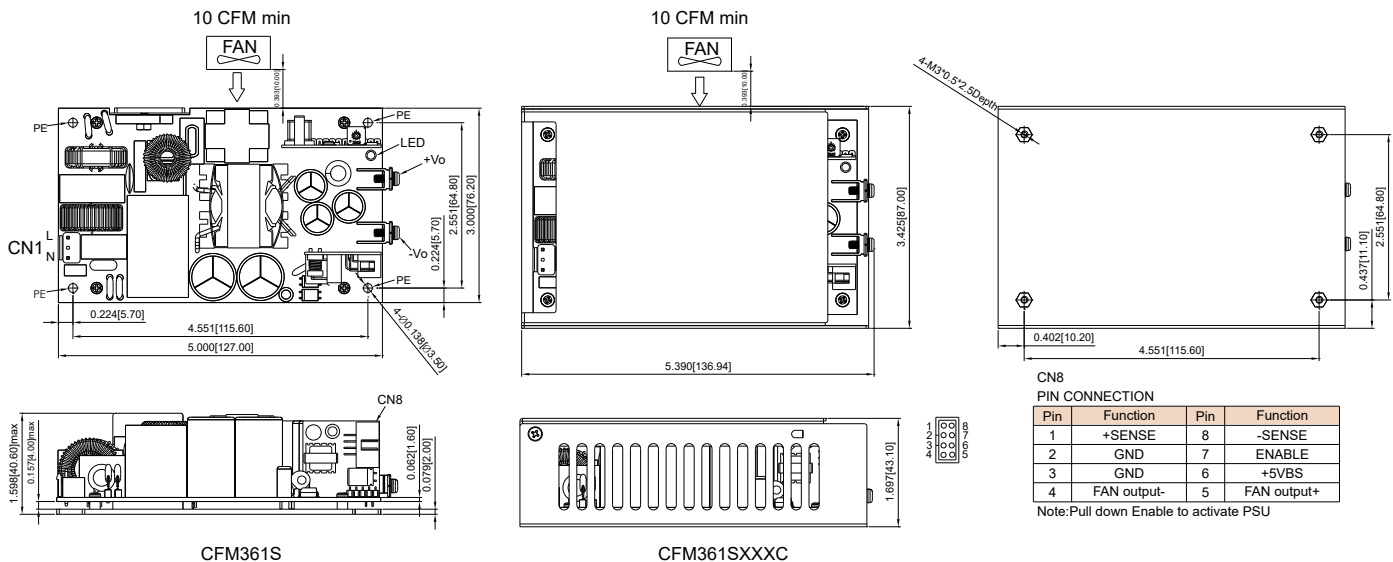

MODEL NUMBER	OUTPUT VOLTAGE	OUTPUT CURRENT	RIPPLE & NOISE (NOTE 1)	VOLTAGE ADJ. RANGE (NOTE 2)	VOLTAGE ACCURACY (NOTE 3)	LINE REGULATION (RANGE)	LOAD REGULATION (NOTE 4)	% EFF. (Typ.) (NOTE 5)
<b>Main Output Voltage</b>								
CFM361S120	+12 V	29.6 A	120 mVp-p	11.4-12.6V	±1.0%	±0.5%	±1%	92.5%
CFM361S240	+24 V	14.8 A	150 mVp-p	22.8-25.2V	±1.0%	±0.5%	±1%	93.5%
CFM361S480	+48 V	7.4 A	150 mVp-p	45.6-50.4V	±1.0%	±0.5%	±1%	93.5%
<b>Stand-by Output Voltage</b>								
All	+5.0 V	0.5	---	---	---	---	---	---
<b>Fan Output Voltage</b>								
All	+12.0 V	0.3	---	---	---	---	---	---



## Derating Curve

### CFM361SXXX (Open Frame)

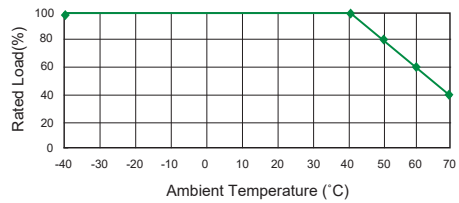
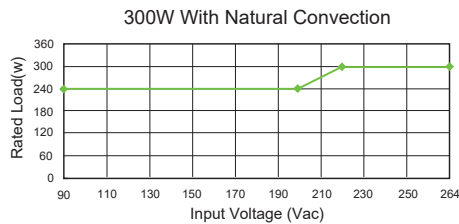
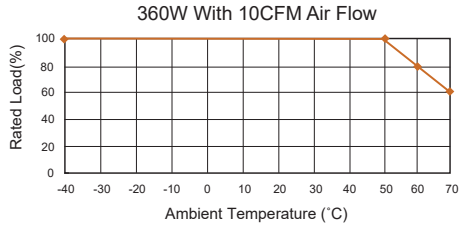

### CFM361SXXXC (With Cover)

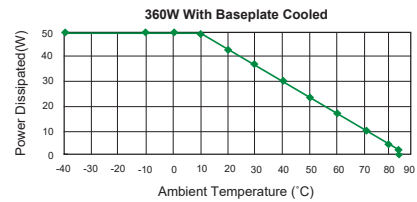
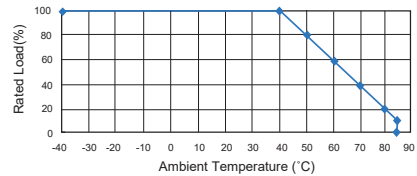
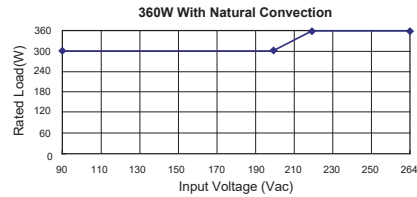
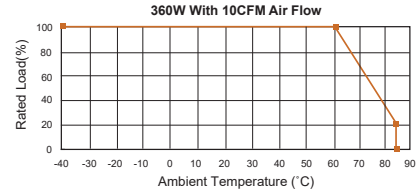

## Specifications

All Specifications Typical At Nominal Line, 75% Load and 25°C Unless Otherwise Noted

### INPUT SPECIFICATIONS

AC Input Voltage	90-264Vac, 120-370Vdc
Frequency	47 to 63Hz
Inrush Current	50A max. @240Vac
Leakage Current @ 264Vac	3.5mA max.

### OUTPUT SPECIFICATIONS

Total Rated Output Power	360W
Remote Voltage Sense	Compensates for wire Voltage drop
Adjustment Range on Vout	±5%
Hold-up Time	12ms typ.
Over Voltage Protection	Recycle AC input to restart
Short Circuit Protection	Hiccup mode(Auto Recovery)
Over Temperature Protection	Auto Recovery
Temperature Coefficient	±0.05%/°C

### SAFETY AND EMISSION

Emission and Immunity	EN55032 Class B, FCC Part 15 Class B EN61000-6-3, EN61000-3-2, EN61000-3-3, EN55024, EN61000-6-1, EN61204-3
Safety	IEC60950-1, EN60950-1, UL60950-1

### GENERAL SPECIFICATIONS

Isolation	Input to output = 4,242VDC
Operating Temperature	see derating curve
Storage Temperature	-40-85°C
Humidity	93% RH max. Non condensing
Switching Frequency	55KHz Typical
MTBF ..... MIL-HDBK-217F, GB, 25°C/115VAC	100Khrs min.
Altitude	2000m
Dimensions:	
Open frame versions	5.000 x 3.000 x 1.598 inches (127.00 x 76.20 x 40.60 mm)
Covered versions	5.391 x 3.425 x 1.697 inches (136.94 x 87.00 x 43.10 mm)
Weight:	
Open frame versions	470g (1.04 Pounds)
Covered versions	550g (1.21 Pounds)

### NOTE

- Add a 0.1µF ceramic capacitor and a 47µF E.L. capacitor to output for ripple & noise measuring @20MHz BW.
- Voltage accuracy is set at 60% rated load and 25°C Ta.
- Line regulation is measured from high line to low line with rated load.
- Load regulation is measured at 60%±40% rated.
- Typical efficiency at 230VAC and full Load at 25°C.
- Power dissipation (Pd):  $Pd = Pi - Po = Po(1-\eta)/\eta$
- Input connectors (CN1) wafer with TAIWAN KING PIN TERMINAL PVHI series and mate with JST housing VHR series or equivalent. Output connectors (CN8) wafer with TAIWAN KING PIN TERMINAL PIDC254M1L series and mate with Molex housing 70450 series or equivalent.



# CFM40C, CFM60C, CFM101C SERIES

## 40 WATT, 60 WATT, 100 WATT

### Features

- ◆ Universal Input Range 90-264VAC
- ◆ Efficiency up to 90%
- ◆ Meets EN55032 and CISPR/FCC Class B
- ◆ Continuous Short Circuit Protection
- ◆ LED Indicator for Power ON
- ◆ Can be Installed on DIN rail TS-35/7.5 or 15



### Mechanical Dimensions

All Dimensions in Inches (mm)  
 Tolerance Inches: X.XX=±0.02, X.XXX=±0.010  
 Millimeters: X.X=±0.5, X.XX=±0.25

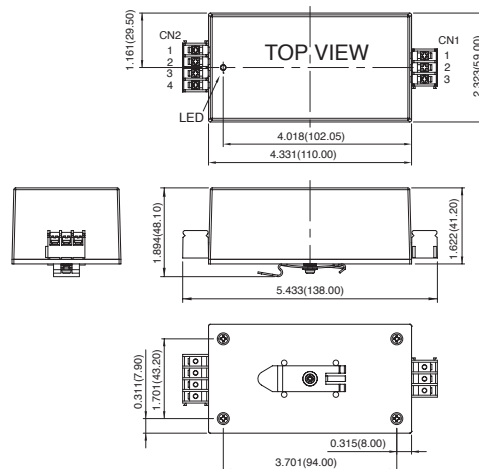

#### CN1 PIN CONNECTION

Pin	Function
Pin 1	ACN
Pin 2	ACL
Pin 3	⏏

#### CN2 PIN CONNECTION

Pin	Function
Pin 1	+ Vout
Pin 2	+ Vout
Pin 3	- Vout
Pin 4	- Vout

#### CFM40CXXX-DR Series

MODEL NUMBER	OUTPUT VOLTAGE	OUTPUT CURRENT	RIPPLE & NOISE	VOLTAGE ACCURACY	LINE REGULATION	LOAD REGULATION	% EFF. (Typ.)
CFM40C033-DR	3.3 V	6 A	50mV	±1%	±0.5%	±1%	70%
CFM40C050-DR	5 V	6 A	1%	±1%	±0.5%	±1%	76%
CFM40C090-DR	9 V	4.45 A	1%	±1%	±0.5%	±1%	84%
CFM40C120-DR	12 V	3.34 A	1%	±1%	±0.5%	±1%	85%
CFM40C150-DR	15 V	2.67 A	1%	±1%	±0.5%	±1%	85%
CFM40C240-DR	24 V	1.67 A	1%	±1%	±0.5%	±1%	85%
CFM40C300-DR	30 V	1.33 A	1%	±1%	±0.5%	±1%	86%
CFM40C360-DR	36 V	1.11 A	1%	±1%	±0.5%	±1%	87%
CFM40C480-DR	48 V	0.834 A	1%	±1%	±0.5%	±1%	87%

#### CFM60CXXX-DR Series

MODEL NUMBER	OUTPUT VOLTAGE	OUTPUT CURRENT	RIPPLE & NOISE	VOLTAGE ACCURACY	LINE REGULATION	LOAD REGULATION	% EFF. (Typ.)
CFM60C033-DR	3.3 V	8 A	50mV	±1%	±0.5%	±1%	72%
CFM60C050-DR	5 V	8 A	1%	±1%	±0.5%	±1%	77%
CFM60C090-DR	9 V	6.67 A	1%	±1%	±0.5%	±1%	84%
CFM60C120-DR	12 V	5 A	1%	±1%	±0.5%	±1%	85%
CFM60C150-DR	15 V	4 A	1%	±1%	±0.5%	±1%	86%
CFM60C240-DR	24 V	2.5 A	1%	±1%	±0.5%	±1%	86%
CFM60C300-DR	30 V	2 A	1%	±1%	±0.5%	±1%	86%
CFM60C360-DR	36 V	1.67 A	1%	±1%	±0.5%	±1%	88%
CFM60C480-DR	48 V	1.25 A	1%	±1%	±0.5%	±1%	88%

#### CFM101CXXX-DR Series

MODEL NUMBER	OUTPUT VOLTAGE	OUTPUT CURRENT	RIPPLE & NOISE	VOLTAGE ACCURACY	LINE REGULATION	LOAD REGULATION	% EFF. (Typ.)	PF (Typ.)
CFM101C120-DR	12 V	8.4 A	1%	±1%	±0.5%	±1%	87%	0.9
CFM101C150-DR	15 V	6.7 A	1%	±1%	±0.5%	±1%	87%	0.9
CFM101C200-DR	20 V	5 A	1%	±1%	±0.5%	±1%	88%	0.9
CFM101C240-DR	24 V	4.2 A	1%	±1%	±0.5%	±1%	88%	0.9
CFM101C480-DR	48 V	2.1 A	1%	±1%	±0.5%	±1%	90%	0.9

## Derating Curve

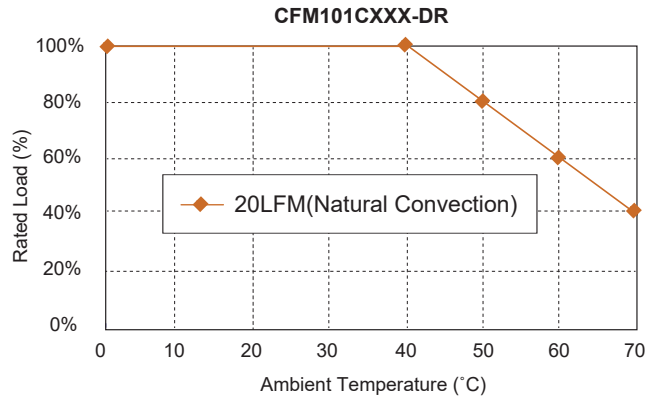
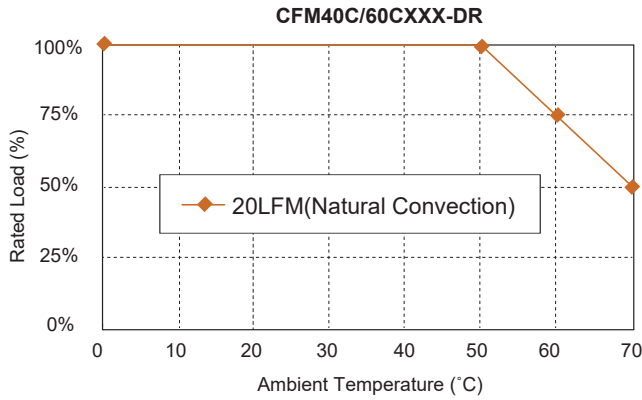

## Specifications

All Specifications Typical At Nominal Line, 75% Load and 25°C Unless Otherwise Noted

### INPUT SPECIFICATIONS

Voltage		90-264Vac, 120-370Vdc
Frequency		47 to 63Hz
Inrush Current	CFM40C/60CXXX-DR	50A max. @240Vac
	CFM101CXXX-DR	90A max. @240Vac
Conducted EMI		CISPR/FCC Class B
Leakage Current		3.5mA max.

### OUTPUT SPECIFICATIONS

Hold-up Time	CFM40C/60CXXX-DR	8ms typ. @115Vac
	CFM101CXXX-DR	10ms typ. @115Vac
Short Circuit Protection		Hiccup Mode (Auto Recover)
Over Voltage Protection		TVS Component to Clamp
Temperature Coefficient		±0.05%/°C

### SAFETY AND EMISSION

Emission and Immunity	EN55032 Class B, FCC Part 15 Class B EN61000-6-3, EN61000-3-2, EN61000-3-3, EN55024, EN61204-3, EN61000-6-1
Safety	IEC60950-1, EN60950-1, UL60950-1

### GENERAL SPECIFICATIONS

Isolation		Input to output= 4,242VDC
Operating Temperature	CFM40C/60CXXX-DR	0-70°C
	CFM101CXXX-DR	0-70°C
Storage Temperature		-20-85°C
Humidity		93% RH max. Non-Condensing
Cooling		Natural Convection
Switching Frequency	CFM40C/60CXXX-DR	66KHz Typical
	CFM101CXXX-DR	100KHz Typical
MTBF		MIL-HDBK-217F, GB, 25°C/115VAC 200Khrs min.
Altitude		2000m
Dimensions		5.433 x 2.323 x 1.894 inches (138.00 x 59.00 x 48.10 mm)
Weight		475 g

### NOTE

1. Voltage accuracy is set at full load and 25°C Ta.
2. Add a 0.1µF ceramic capacitor and a 10µF E.L. capacitor to output for ripple & noise measuring @20MHz BW.
3. Line regulation is measured from high line to low line with full load.
4. Load regulation is measured from full to 10% load.
5. CFM40C/60C/101C input connector mates with DECA T40MBB27-03 (Pitch 6.35mm) 3pin positions terminal blocks.
6. CFM40C/60C/101C Output connector mates with DECA T40MBB27-04 (Pitch 6.35mm) 4pin positions terminal blocks

# CBM100S Series

## 100 WATT, AC-DC FULL BRICK POWER MODULE

### Features

- ◆ Universal Input Range 90-264VAC
- ◆ Full Load with Baseplate Cooled and No Fan Required
- ◆ Wide Operating Temperature Range
- ◆ 17mm Ultra Low Profile
- ◆ Safety Meets EN60950-1
- ◆ Built-in EN55032 Class B Filter
- ◆ Active PFC Meets EN61000-3-2
- ◆ High Efficiency up to 91% Typical
- ◆ No Load Input Power Consumption < 0.5W
- ◆ Over Temperature Protection
- ◆ Over Voltage Protection
- ◆ Over Current Protection



### Mechanical Dimensions

All Dimensions In Inches(mm)

Tolerance Inches: x.xx= ±0.02, x.xxx= ±0.010  
 Millimeters: x.x= ±0.5, x.xx= ±0.25

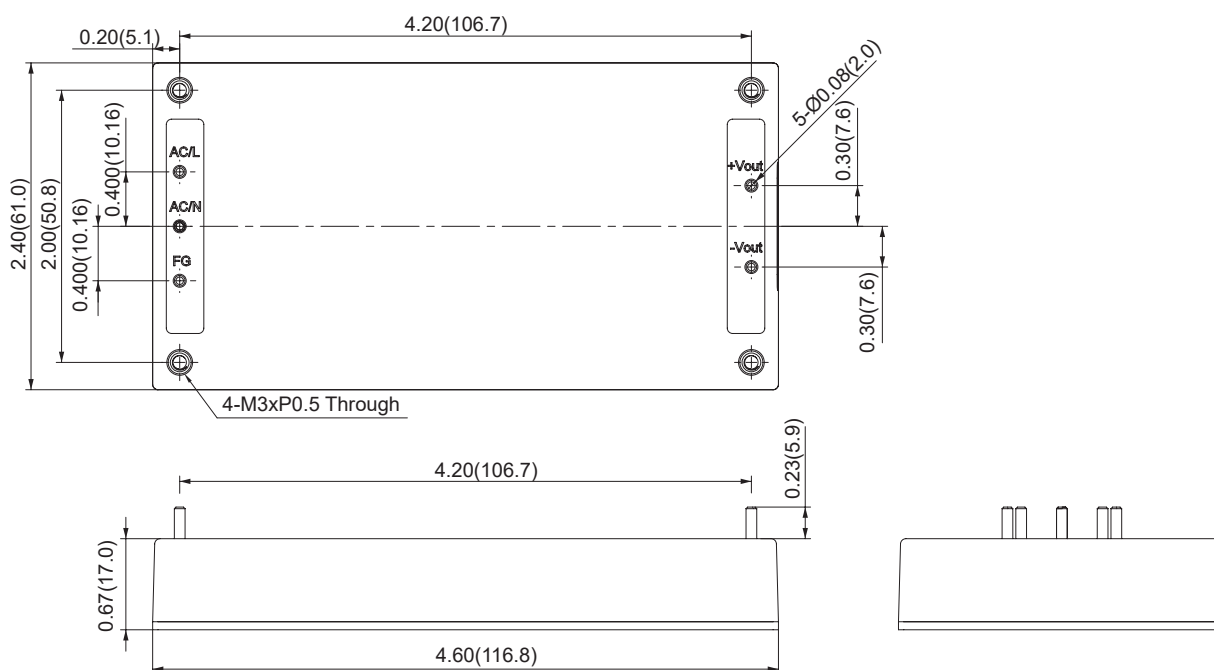

MODEL NUMBER	OUTPUT VOLTAGE	OUTPUT CURRENT	RIPPLE & NOISE (NOTE 1)	VOLTAGE ACCURACY (NOTE 2)	LINE REGULATION (NOTE 3)	LOAD REGULATION (NOTE 4)	% EFF. (Typ.) (NOTE 5)
CBM100S120	+12 V	8.4 A	1.0%	±1.0%	±0.5%	±1%	90%
CBM100S240	+24 V	4.2 A	1.0%	±1.0%	±0.5%	±1%	91%
CBM100S280	+28 V	3.6 A	1.0%	±1.0%	±0.5%	±1%	91%
CBM100S360	+36 V	2.8 A	1.0%	±1.0%	±0.5%	±1%	91%
CBM100S480	+48 V	2.1 A	1.0%	±1.0%	±0.5%	±1%	90.5%

## Derating Curve

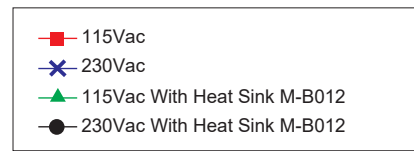
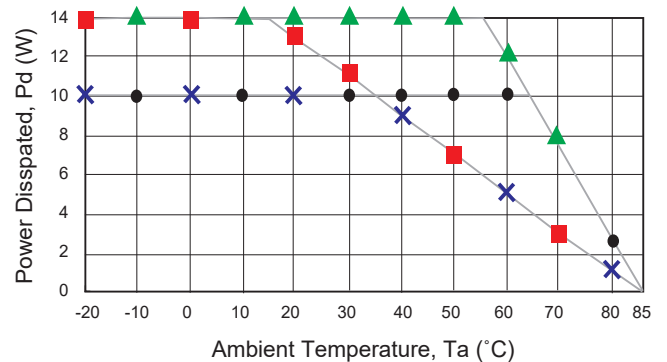
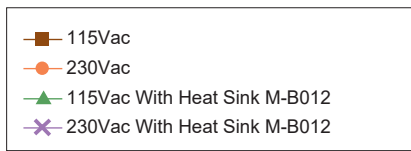
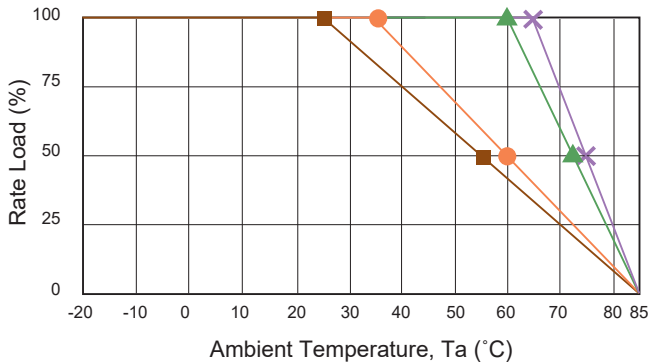

## Specifications

All Specifications Typical At Nominal Line, 75% Load and 25°C Unless Otherwise Noted

### INPUT SPECIFICATIONS

AC Input Voltage	90-264Vac, 120-370Vdc
Frequency	47 to 63Hz
Inrush Current	100A max. @240Vac
Leakage Current @ 264Vac	3.5mA max.

### OUTPUT SPECIFICATIONS

Isolation	Input to output= 4242VDC
Total Rated Output Power	100W
Hold-up Time	12ms typ.
Over Voltage Protection	Recycle AC input to restart
Short Circuit Protection	Hiccup mode (Auto Recovery)
Over Current Protection	Auto Recovery
Over Temperature Protection	Auto Recovery
Temperature Coefficient	±0.05%/°C

### SAFETY AND EMISSION

Emission and Immunity	EN55032 Class B, FCC Part 15 Class B, EN61000-6-3, EN61000-3-2, EN61000-3-3 EN55024, EN61000-6-1, EN61204-3
Safety	IEC60950-1, EN60950-1, UL60950-1

### GENERAL SPECIFICATIONS

Operating Ambient Temperature	-20 -85° C (see derating curve)
Operating Case Temperature	+85°C max.
Storage Temperature	-40-100°C
Humidity	93% RH max. Non condensing
Switching Frequency	130KHz Typical
MTBF ... MIL-HDBK-217F, GB, 25°C/115VAC	100Khrs min.
No Load Input Power Consumption	< 0.5W
Altitude	2000m
Dimensions	4.60 x 2.40 x 0.67 inches (116.8 x 61.0 x 17.0 mm)
Weight	236 g (0.52 Pounds)

### NOTE

- 1.CBM100S series: Add a 0.1µF ceramic capacitor and a 10µF E.L. capacitor to output for ripple & noise measuring @20MHz BW.
2. Voltage accuracy is set at 60% rated load.
3. Line regulation is measured from high line to low line with rated load.
4. Load regulation is measured at 60%±40% rated.
5. Typical efficiency with 230VAC and full load at 25°C.
6. Power dissipation (Pd):  $Pd = Pi - Po = Po(1-\eta)/\eta$ .

# TRE06S SERIES

## 6W SWITCHING ADAPTER

### Features

- ◆ Miniature Size
- ◆ Universal Input: 90-264Vac
- ◆ Meets EN55032 Class B and CISPR/FCC Class B
- ◆ Continuous Short Circuit Protection
- ◆ Meet CoC Tier 2 & DoE Level VI (Output Cable Length  $\leq$  1800mm)
- ◆ No Load Power Consumption < 75mW
- ◆ Constant Current (Optional)
- ◆ Class II
- ◆ Optional US&EU AC Plugs



### Ordering information

TRE06SXXX	X	XX	X	XX
Model No.	AC Plug Type	DC Plug Type	OVP	DC Cable Length and Type
	A:USA 2 Pin	E:Europe 2 pin	A: Without OVP	01: 720mm
				02: 1220mm
				03: 1800mm
				11: 720mm with Ferrite Core
				12: 1220mm with Ferrite Core
				13: 1800mm with Ferrite Core
				* 22AWG for 5V, UL2468
				* 24AWG for 9V 12V 15V, UL2468

### Mechanical Dimensions

All Dimensions are in inches[mm]  
Tolerance:Inches:X.XXX±0.02  
Millimeters:X.XX±0.5  
UNIT: inches[mm]

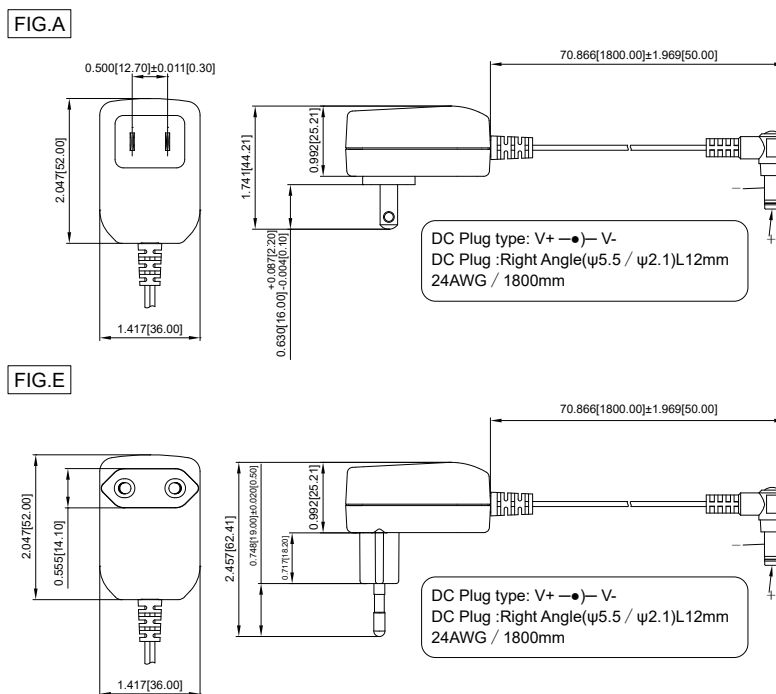

MODEL NUMBER	OUTPUT VOLTAGE	OUTPUT CURRENT	RIPPLE NOISE (NOTE 1)	VOLTAGE ACCURACY (NOTE 2)	LINE REGULATION (NOTE 3)	LOAD REGULATION (NOTE 4)	% EFF. (Typ.) (NOTE 5)
TRE06S050	5 V	1200mA	100mVp-p	±4%	±1%	±3%	77.79%
TRE06S090	9 V	650mA	100mVp-p	±3%	±1%	±2%	81.39%
TRE06S120	12 V	500mA	120mVp-p	±3%	±1%	±2%	81.57%
TRE06S150	15 V	400mA	120mVp-p	±3%	±1%	±2%	82.61%

## Derating Curve

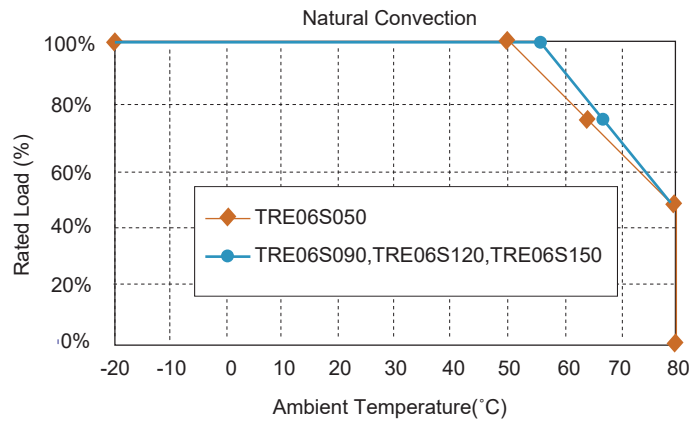

## Specifications

All Specifications Typical At Nominal Line, Full Load, and 25°C Unless Otherwise Noted

### INPUT SPECIFICATIONS

Voltage	90-264Vac, 120-370Vdc
Frequency	47 to 63Hz
Inrush Current	Cold Start @25°C 90A max. @ 240Vac
Leakage Current	0.25mA max.
Input Current	0.25A max.

### OUTPUT SPECIFICATIONS

Holdup Time	10ms typ. @115Vac
Short Circuit Protection	Hiccup Mode Continuous(Auto Recovery)
Temperature Coefficient	±0.05%/°C

### SAFETY AND EMISSION

Emission and Immunity	EN55032 Class B, FCC Part 15 Class B EN61000-6-3, EN61000-3-2, EN61000-3-3 EN55024, EN61204-3, EN61000-6-1
Safety	Class II, IEC62368-1/60950-1 UL62368-1/60950-1

### GENERAL SPECIFICATIONS

Isolation	Input to output 3,000VAC
Operating Temperature	-20-80°C(see derating curve)
Storage Temperature	-20-85°C
Humidity	93% RH max. Non condensing
Cooling	Natural Convection
Switching Frequency	30-70KHz typ.
MTBF	MIL-HDBK-217F, GB, 25°C/115VAC 900khrs min.
Altitude	4000m
Dimensions	2.047x1.417x0.992inches (52.00x36.00x25.21mm)
Weight	55g(0.12 Pounds)

### NOTE

1. Add a 0.1uF ceramic capacitor and a 10uF E.L. capacitor to output for ripple&noise measuring @20MHz BW.
2. Voltage setpoint at 60% load.
3. Line regulation measured from 100Vac to 240Vac, full load.
4. Load regulation measured from 60% to full load and from 60% to 20% load (60% +/- 40% load).
5. Efficiency with 230 VAC and 75% load 25°C.

# TRG10R SERIES

## 10 WATT, LEVEL VI EFFICIENCY

### Features

- ◆ Universal Input: 90-264VAC
- ◆ Continuous Short Circuit Protection
- ◆ Interchangeable AC Plugs
- ◆ EMI Meets EN55032 Class "B" and CISPR/FCC Class B
- ◆ Over Voltage Protection
- ◆ No Load Power Consumption < 75mW
- ◆ Approved IEC62368-1, EN62368-1, EN62368-1
- ◆ Meet CoC V5 Tier 2 & DoE Level VI  
(Output cable length  $\geq$  1800mm)



### Ordering information

TRG10RXXX - Model No.	XX DC Plug Type	E OVP	XX DC Cable Length and Type
			01: 720mm
			02: 1220mm
			03: 1800mm
			11: 720mm with Ferrite Core
			12: 1220mm with Ferrite Core
			13: 1800mm with Ferrite Core
			* 18AWG / UL1185 for Vo: 5V, 5.9V, 6V, 7.5V, 9V
			* 20AWG / UL1185 for Vo: 12V, 13.6V
			* 22AWG / UL1185 for Vo: 15V, 18V
			* 24AWG / UL1185 for Vo: 24V

### Mechanical Dimensions

All Dimensions in Inches (mm)  
 Tolerance Inches: X.XXX=±0.02  
 Millimeters: X.XX=±0.5

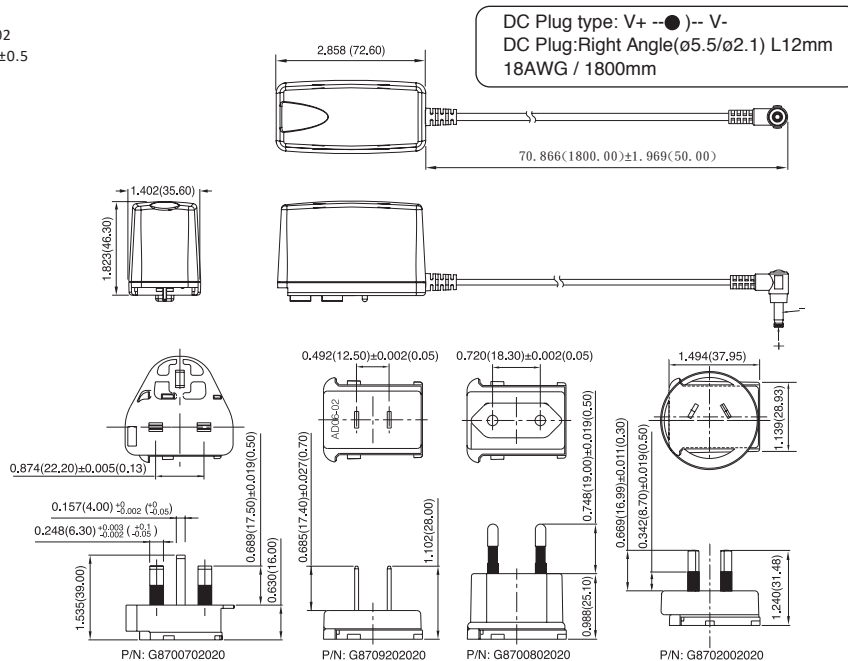

MODEL NUMBER	OUTPUT VOLTAGE	OUTPUT CURRENT	RIPPLE & NOISE (NOTE 1)	VOLTAGE ACCURACY (NOTE 2)	LINE REGULATION (NOTE 3)	CURRENT REGULATION (NOTE 4)	AVERAGE EFFICIENCY MIN. (NOTE 5)
TRG10R050	5 V	1.6 A	50mVp-p	±2%	±1%	±4%	77.37%
TRG10R059	5.9 V	1.5 A	1%	±2%	±1%	±3%	78.12%
TRG10R060	6 V	1.5 A	1%	±2%	±1%	±3%	81.57%
TRG10R075	7.5 V	1.2 A	1%	±2%	±1%	±3%	81.57%
TRG10R090	9 V	1.1 A	1%	±2%	±1%	±2%	82.14%
TRG10R120	12 V	0.85 A	1%	±2%	±1%	±2%	82.32%
TRG10R136	13.6 V	0.75 A	1%	±2%	±1%	±2%	82.32%
TRG10R150	15 V	0.7 A	1%	±2%	±1%	±2%	82.49%
TRG10R180	18 V	0.55 A	1%	±2%	±1%	±2%	82.14%
TRG10R240	24 V	0.4 A	1%	±2%	±1%	±2%	81.96%



## Derating Curve

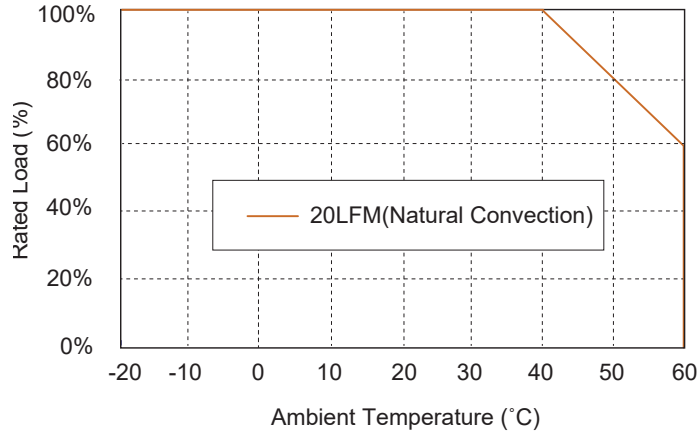

## Specifications

All Specifications Typical At Nominal Line, 75% Load and 25°C Unless Otherwise Noted

### INPUT SPECIFICATIONS

Voltage	90-264Vac, 120-270Vdc
Frequency	47 to 63Hz
Input Current	0.4A max.
Inrush Current	Cold Start @25°C 40A max. @ 240Vac
Conducted EMI	CISPR/FCC Class B
Leakage Current	0.25mA max

### OUTPUT SPECIFICATIONS

Hold-up Time	10mS typ. @115Vac
Short Circuit Protection	Continuous (Auto Recovery) TVS
Over Voltage Protection	Component to Clamp
Temperature Coefficient	±0.05%/°C

### SAFETY AND EMISSION

Emission and Immunity	EN55032 Class B, FCC Part 15 Class B EN61000-6-3, EN61000-3-2, EN61000-3-3, EN55024, EN61204-3, EN61000-6-1 Class II,
Safety	Class II, IEC62368-1/609501-1, EN62368-1/60950-1, UL62368-1/60950-1

### GENERAL SPECIFICATIONS

Isolation	Input to output= 4,242VDC
Operating Temperature	-20-60°C (see derating curve)
Storage Temperature	-20-85°C
Humidity	93% RH max. Non condensing
Cooling	Natural Convection
Switching Frequency	67KHz typ.
MTBF (MIL-HDBK-217F, GB, 25°C/115VAC)	200K hrs min.
Altitude	2000m
Dimensions	2.858 x 1.823 x 1.402 inches (72.6 x 46.3 x 35.6 mm)
Weight	130 g (0.29 Pounds)

### NOTE

1. Add a 0.1µF ceramic capacitor and a 10µF E.L. capacitor to output for Ripple & noise measuring @20MHz BW.
2. Voltage setpoint at 60% full load.
3. Line regulation measured from 100Vac to 240VAC full load.
4. Load regulation measured from 60% to full load and from 60% to 20% load (60% +/- 40% load).

# TRE15 SERIES

## 1.5W SWITCHING ADAPTER

### Features

- ◆ Universal Input Range 90-264Vac
- ◆ Meets EN55032 Class B and CISPR/FCC Class B
- ◆ Continuous Short Circuit Protection
- ◆ Over Voltage Protection
- ◆ No Load Power Consumption<75mW
- ◆ Approved IEC62368-1, UL62368-1, EN62368-1
- ◆ Meet CoC Tier 2 & DoE Level VI  
(Output Cable Length  $\leq$  1800mm)



### Ordering information

Model No.	AC Plug Type	DC Plug Type	UL1571 WITH OVP	DC Cable Length and Type
TRE15XX - x	-XX	G	XX	
A: USA 2 Pin				01: 720mm
E: Europe 2 Pin				02: 1220mm
U: British 3 Pin				03: 1800mm
				11: 720mm with Ferrite Core
				12: 1220mm with Ferrite Core
				13: 1800mm with Ferrite Core
				* 20AWG for 5V, UL1571 or Equivalent
				* 18AWG for 9V, UL1571 or Equivalent
				* 24AWG for 12V, 15V, 24V, UL1571 or Equivalent

### Mechanical Dimensions

All Dimensions are in inches[mm]  
Tolerance: Inches:X.XXX±0.02  
Millimeters:X.XX±0.5

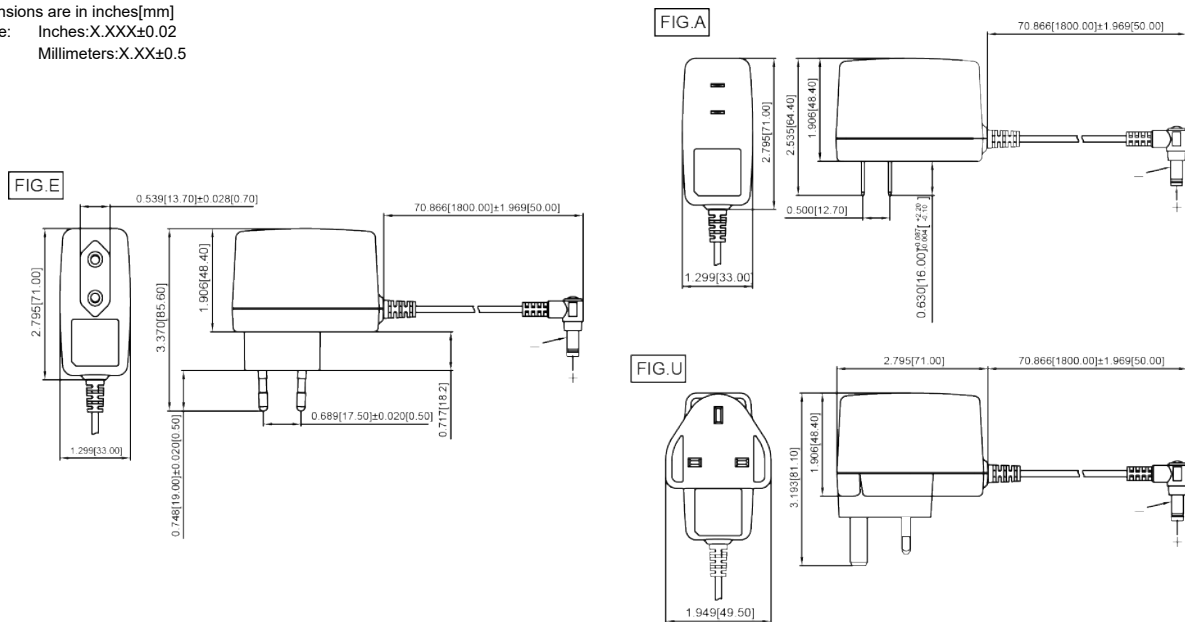

MODEL	OUTPUT VOLTAGE	OUTPUT CURRENT	RIPPLE & NOISE (NOTE 1)	VOLTAGE ACCURACY (NOTE 2)	LINE REGULATION (NOTE 3)	LOAD REGULATION (NOTE 4)	AVERAGE EFFICIENCY min (NOTE 5)
TRE15050	5 V	2.0 A	50mVp-p	±2%	±1%	±4%	79.0%
TRE15090	9 V	1.4 A	90mVp-p	±2%	±1%	±2%	83.5%
TRE15120	12 V	1.0 A	100mVp-p	±2%	±1%	±2%	83.5%
TRE15150	15 V	1.0 A	100mVp-p	±2%	±1%	±2%	84.5%
TRE15240	24 V	0.63 A	100mVp-p	±2%	±1%	±2%	84.5%

## Derating Curve

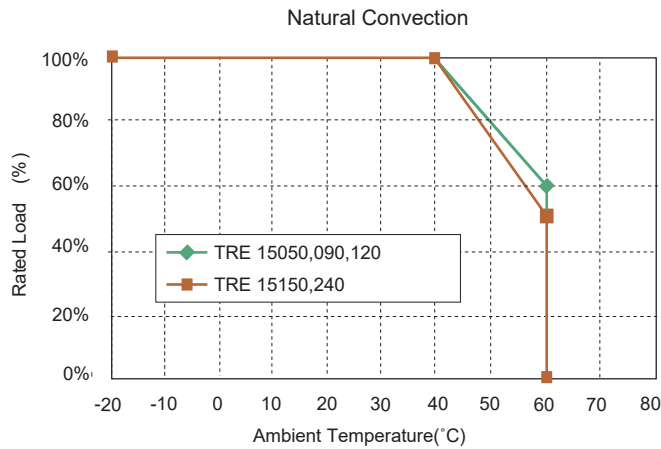

## Specifications

All Specifications Typical At Nominal Line, Full Load, and 25°C Unless Otherwise Noted

### INPUT SPECIFICATIONS

Voltage	90-264Vac
Frequency	47 to 63Hz
Input Current	0.5A max
Inrush Current	Cold Start @25°C 50A max. @ 240Vac
Leakage Current	0.25mA max.

### OUTPUT SPECIFICATIONS

Holdup Time	10ms typ. @115Vac
Short Circuit Protection	Continuous(Auto Recovery)
Over Voltage Protection	IC Component to Clamp
Temperature Coefficient	±0.05% / °C

### SAFETY AND EMISSION

Emission and Immunity	EN55032 Class B, FCC Part 15 Class B EN61000-6-3, EN61000-3-2, EN61000-3-3 EN55024, EN61204-3, EN61000-6-1
Safety	Class II, IEC62368-1/60950-1, UL62368-1/60950-1 EN62368-1/60950-1

### GENERAL SPECIFICATIONS

Isolation	Input to output = 3,000VAC
Operating Temperature	-20-60°C(see derating curve)
Storage Temperature	-20-85°C
Humidity	93% RH max. Non condensing
Cooling	Natural Convection
Switching Frequency	Full Load 115V/85KHz typ 230V/65KHz typ MIL-HDBK-217F, GB, at 25°C/115VAC 330Khrs min.
MTBF	5000m
Altitude	2.795x1.906x1.299 inches (71.00x48.4x33.00mm)
Dimensions	
Weight	100g(0.22 Pounds)

### NOTE

1. Add a 0.1uF ceramic capacitor and a 10uF E.L. capacitor to output for ripple & noise measuring @20MHz BW.
2. Voltage setpoint at 60% full load.
3. Line regulation measured from 100Vac to 240Vac full load.
4. Load regulation measured from 60% to full load and from 60% to 20% load (60% +/- 40% load).
5. Average Efficiency measured at 25%,50%,75%,100% load and input voltage is 115Vac/230Vac.

# TRE15R SERIES

## 15W SWITCHING ADAPTER

### Features

- ◆ Universal Input Range 90-264Vac
- ◆ Interchangeable AC Plugs
- ◆ Meets EN55032 Class B and CISPR/FCC Class B
- ◆ Continuous Short Circuit Protection
- ◆ Over Voltage Protection
- ◆ No Load Power Consumption<75mW
- ◆ Approved IEC62368-1, UL62368-1, EN62368-1
- ◆ Meet CoC Tier 2 & DoE Level VI  
(Output Cable Length  $\leq$  1800mm)



### Ordering information

TRE15RXX - XX	G	XX
Model No.	DC Plug Type	UL1571 WITH OVP
		DC Cable Length and Type
		01: 720mm
		02: 1220mm
		03: 1800mm
		11: 720mm with Ferrite Core
		12: 1220mm with Ferrite Core
		13: 1800mm with Ferrite Core
		* 20AWG for 5V, UL1571 or Equivalent
		* 18AWG for 9V, UL1571 or Equivalent
		* 24AWG for 12V, 15V, 24V, UL1571 or Equivalent



### Mechanical Dimensions

All Dimensions are in inches(mm)  
 Tolerance: Inches:X.XXX±0.02  
 Millimeters:X.XX±0.5

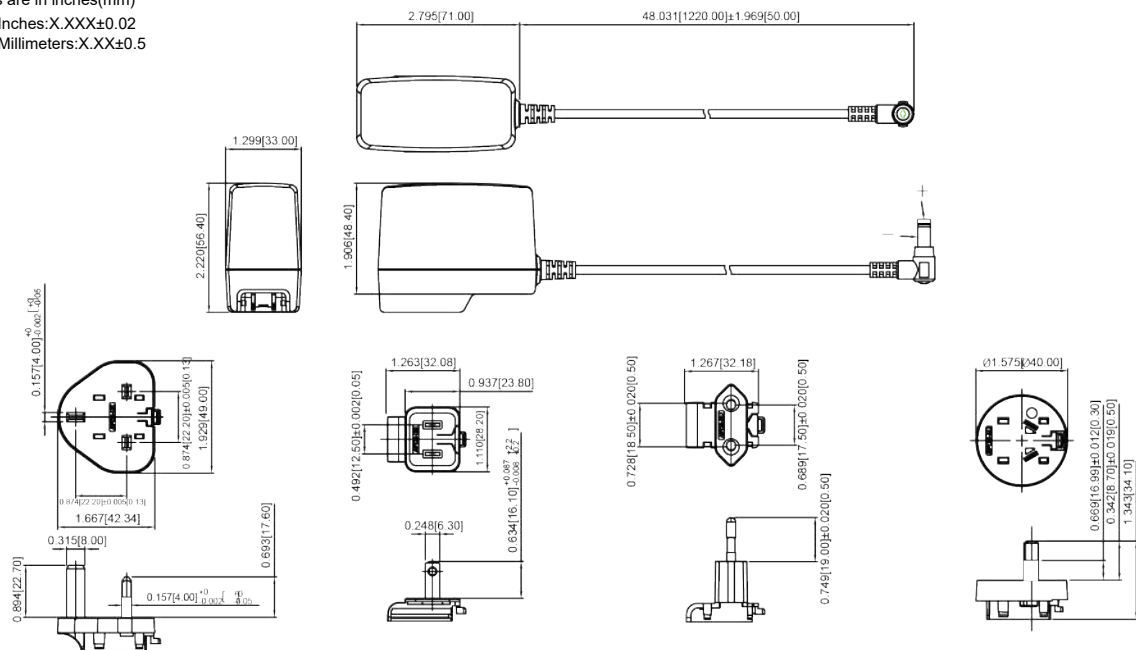

MODEL	OUTPUT VOLTAGE	OUTPUT CURRENT	RIPPLE & NOISE (NOTE 1)	VOLTAGE ACCURACY (NOTE 2)	LINE REGULATION (NOTE 3)	LOAD REGULATION (NOTE 4)	AVERAGE EFFICIENCY min (NOTE 5)
TRE15R050	5 V	2.0 A	50mVp-p	±2%	±1%	±4%	79.0%
TRE15R090	9 V	1.4 A	90mVp-p	±2%	±1%	±2%	83.5%
TRE15R120	12 V	1.0 A	100mVp-p	±2%	±1%	±2%	83.5%
TRE15R150	15 V	1.0 A	100mVp-p	±2%	±1%	±2%	84.5%
TRE15R240	24 V	0.63 A	100mVp-p	±2%	±1%	±2%	84.5%

## Derating Curve

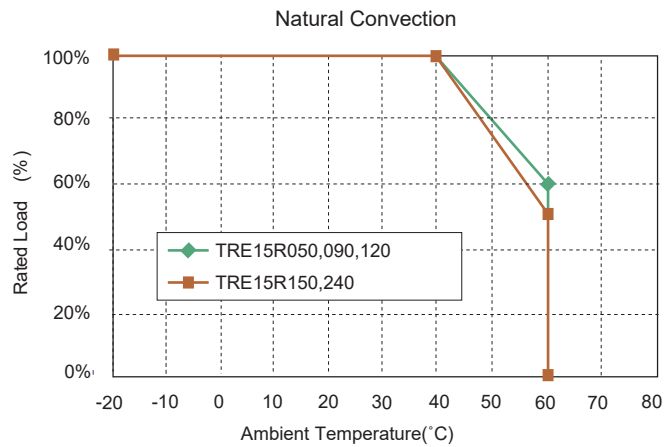

## Specifications

All Specifications Typical At Nominal Line, Full Load, and 25°C Unless Otherwise Noted

### INPUT SPECIFICATIONS

Voltage	90-264Vac
Frequency	47 to 63Hz
Input Current	0.5A max
Inrush Current	Cold Start @25°C 50A max. @ 240Vac
Leakage Current	0.25mA max.

### OUTPUT SPECIFICATIONS

Holdup Time	10ms typ. @115Vac
Short Circuit Protection	Continuous(Auto Recovery)
Over Voltage Protection	IC Component to Clamp
Temperature Coefficient	±0.05% / °C

### SAFETY AND EMISSION

Emission and Immunity	EN55032 Class B, FCC Part 15 Class B EN61000-6-3, EN61000-3-2, EN61000-3-3 EN55024, EN61204-3, EN61000-6-1
Safety	Class II, IEC62368-1/60950-1, UL62368-1/60950-1 EN62368-1/60950-1

### GENERAL SPECIFICATIONS

Isolation	Input to output = 3,000VAC
Operating Temperature	-20-60°C(see derating curve)
Storage Temperature	-20-85°C
Humidity	93% RH max. Non condensing
Cooling	Natural Convection
Switching Frequency	Full Load 115V/ 5KHz typ 230V/65KHz typ MIL-HDBK-217F, GB, at 25° C/115VAC 330Khrs min. 5000m
MTBF	2.795 x 2.220 x 1.299 inches (71.00 x 56.4 x 33.00mm)
Altitude	100g(0.22 Pounds)
Dimensions	
Weight	

### NOTE

1. Add a 0.1uF ceramic capacitor and a 10uF E.L. capacitor to output for ripple & noise measuring @20MHz BW.
2. Voltage setpoint at 60% full load.
3. Line regulation measured from 100Vac to 240Vac full load.
4. Load regulation measured from 60% to full load and from 60% to 20% load (60% +/- 40% load).
5. Average Efficiency measured at 25%,50%,75%,100% load and input voltage is 115Vac/230Vac.

# TRE15RD SERIES

## 1.5W SWITCHING ADAPTER

### Features

- ◆ Universal Input Range 90-264Vac
- ◆ Interchangeable AC Plugs
- ◆ Meets EN55032 Class B and CISPR/FCC Class B
- ◆ Continuous Short Circuit Protection
- ◆ Over Voltage Protection
- ◆ No Load Power Consumption < 75mW
- ◆ Approved IEC62368-1, UL62368-1, EN62368-1
- ◆ Meet CoC Tier 2 & DoE Level VI  
(Output Cable Length  $\leq$  1800mm)



### Ordering information

TRE15RDXX - XX	G	XX
Model No.	DC Plug Type	UL1571 WITH OVP
		DC Cable Length and Type
		01: 720mm
		02: 1220mm
		03: 1800mm
		11: 720mm with Ferrite Core
		12: 1220mm with Ferrite Core
		13: 1800mm with Ferrite Core
		* 20AWG for 5V, UL1571 or Equivalent
		* 18AWG for 9V, UL1571 or Equivalent
		* 24AWG for 12V, 15V, 24V, UL1571 or Equivalent



### Mechanical Dimensions

All Dimensions are in inches(mm)  
Tolerance: Inches: X.XXX $\pm$ 0.02  
Millimeters: X.XX $\pm$ 0.5  
UNIT: inches(mm)

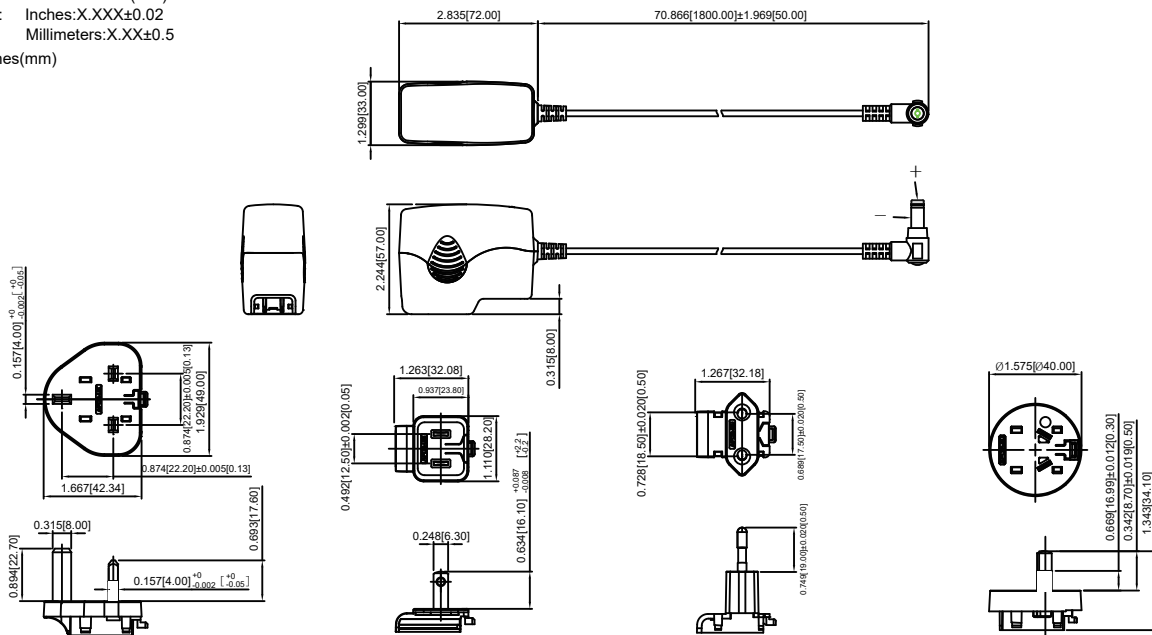

MODEL	OUTPUT VOLTAGE	OUTPUT CURRENT	RIPPLE & NOISE (NOTE 1)	VOLTAGE ACCURACY (NOTE 2)	LINE REGULATION (NOTE 3)	LOAD REGULATION (NOTE 4)	AVERAGE EFFICIENCY min (NOTE 5)
TRE15RD050	5 V	2.0 A	50mVp-p	$\pm$ 2%	$\pm$ 1%	$\pm$ 4%	79.0%
TRE15RD090	9 V	1.4 A	90mVp-p	$\pm$ 2%	$\pm$ 1%	$\pm$ 2%	83.5%
TRE15RD120	12 V	1.0 A	100mVp-p	$\pm$ 2%	$\pm$ 1%	$\pm$ 2%	83.5%
TRE15RD150	15 V	1.0 A	100mVp-p	$\pm$ 2%	$\pm$ 1%	$\pm$ 2%	84.5%
TRE15RD240	24 V	0.63 A	100mVp-p	$\pm$ 2%	$\pm$ 1%	$\pm$ 2%	84.5%

## Derating Curve

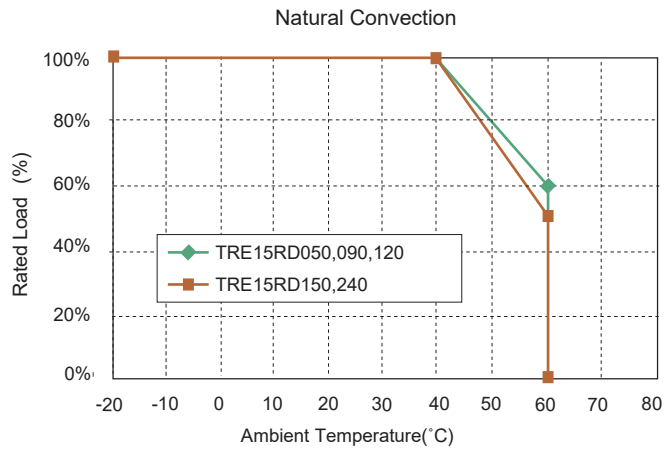

## Specifications

All Specifications Typical At Nominal Line, Full Load, and 25°C Unless Otherwise Noted

### INPUT SPECIFICATIONS

Voltage	90-264Vac
Frequency	47 to 63Hz
Input Current	0.5A max
Inrush Current	Cold Start @25°C 50A max. @ 240Vac
Leakage Current	0.25mA max.

### OUTPUT SPECIFICATIONS

Holdup Time	10ms typ. @115Vac
Short Circuit Protection	Continuous(Auto Recovery)
Over Voltage Protection	IC Component to Clamp
Temperature Coefficient	±0.05% / °C

### SAFETY AND EMISSION

Emission and Immunity	EN55032 Class B, FCC Part 15 Class B EN61000-6-3, EN61000-3-2, EN61000-3-3 EN55024, EN61204-3, EN61000-6-1
Safety	Class II, IEC62368-1/60950-1, UL62368-1/60950-1 EN62368-1/60950-1

### GENERAL SPECIFICATIONS

Isolation	Input to output = 3,000VAC
Operating Temperature	-20-60°C(see derating curve)
Storage Temperature	-20-85°C
Humidity	93% RH max. Non condensing
Cooling	Natural Convection
Switching Frequency	Full Load 115V/ 85KHz typ 230V/65KHz typ MIL-HDBK-217F, GB, at 25°C/115VAC 330Khrs min.
MTBF	5000m
Altitude	2.835 x 2.244 x 1.299 inches (72.00 x 57.0 x 33.00mm)
Dimensions	
Weight	100g(0.22 Pounds)

### NOTE

1. Add a 0.1uF ceramic capacitor and a 10uF E.L. capacitor to output for ripple & noise measuring @20MHz BW.
2. Voltage setpoint at 60% full load.
3. Line regulation measured from 100Vac to 240Vac full load.
4. Load regulation measured from 60% to full load and from 60% to 20% load (60% +/- 40% load).
5. Average Efficiency measured at 25%,50%,75%,100% load and input voltage is 115Vac/230Vac.



# TRG15 SERIES

## 15 WATT, LEVEL VI EFFICIENCY

### Features

- ◆ Universal Input Range 90-264VAC
- ◆ Meets EN55032 Class B and CISPR/FCC Class B
- ◆ Continuous Short Circuit Protection
- ◆ Over Voltage Protection
- ◆ No Load Power Consumption < 75mW
- ◆ Approved IEC62368-1, EN62368-1, EN62368-1
- ◆ Meets CoC Tier 2 & DoE Level VI  
(Output cable length  $\leq$  1800mm)  
(TRG1506: Output Cable Length  $\leq$  1220mm)



### Ordering information

TRG15XX - Model No.	x AC Plug Type A: USA 2 Pin E: Europe 2 Pin U: British 3 Pin S: Australia 2 Pin	-XX DC Plug Type	E OVP	XX DC Cable Length and Type 01: 720mm 02: 1220mm 03: 1800mm 11: 720mm with Ferrite Core 12: 1220mm with Ferrite Core 13: 1800mm with Ferrite Core * 18AWG / UL1185 FOR 5V,7.5V,9V * 16AWG / UL1185 FOR 6V * 20AWG/UL1185FOR12V,13.6V,15V,18V,24V
---------------------	---	------------------	-------	---



### Mechanical Dimensions

All Dimensions in Inches (mm)

Tolerance Inches: X.XXX $\pm$ 0.02

Millimeters: X.XX $\pm$ 0.5

FIG.A

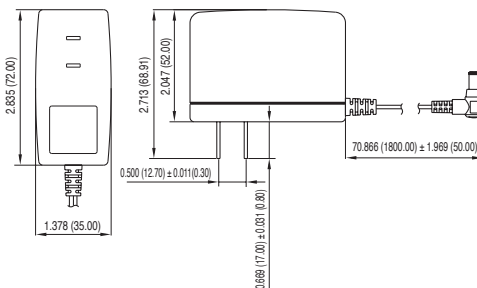

FIG.E

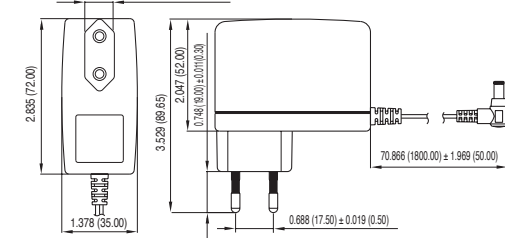

FIG.S

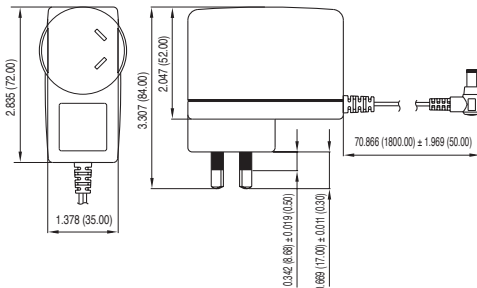
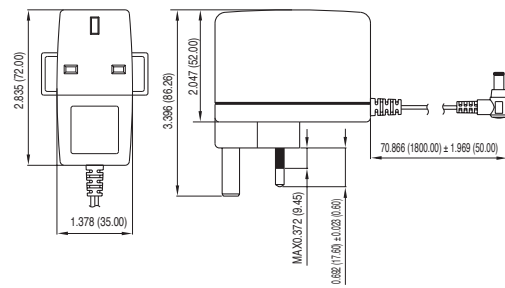
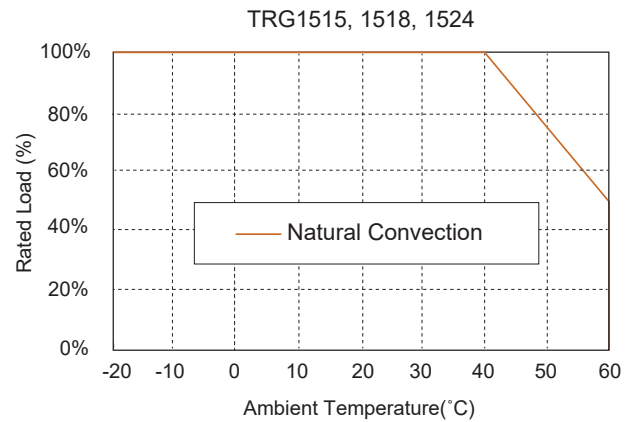
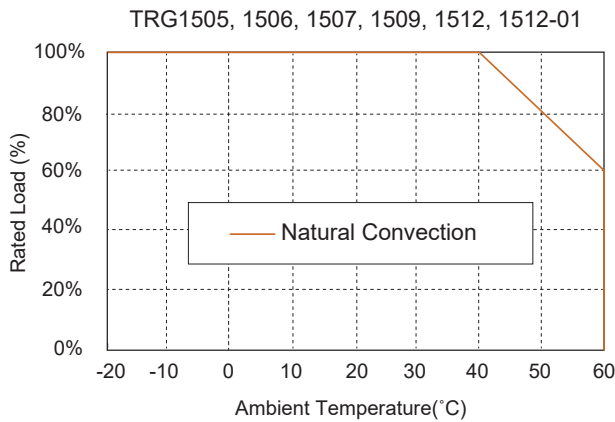

FIG.U



MODEL NUMBER	OUTPUT VOLTAGE	OUTPUT CURRENT	RIPPLE & NOISE (NOTE 1)	VOLTAGE ACCURACY (NOTE 2)	LINE REGULATION (NOTE 3)	CURRENT REGULATION (NOTE 4)	AVERAGE EFFICIENCY MIN. (NOTE 5)
TRG1505	5 V	2.0 A	50mVp-p	±2%	±1%	±4%	79%
TRG1506	6 V	1.5 A	60mVp-p	±2%	±1%	±3%	81.57%
TRG1507	7.5 V	1.6 A	75mVp-p	±2%	±1%	±3%	83.26%
TRG1509	9 V	1.4 A	90mVp-p	±2%	±1%	±2%	83.54%
TRG1512	12 V	1.0 A	100mVp-p	±2%	±1%	±2%	83.26%
TRG1512-01	13.6 V	1.0 A	100mVp-p	±2%	±1%	±2%	83.97%
TRG1515	15 V	1.0 A	100mVp-p	±2%	±1%	±2%	84.5%
TRG1518	18 V	0.83 A	100mVp-p	±2%	±1%	±2%	84.48%
TRG1524	24 V	0.63 A	100mVp-p	±2%	±1%	±2%	84.54%

## Derating Curve



## Specifications

All Specifications Typical At Nominal Line, 75% Load and 25°C Unless Otherwise Noted

### INPUT SPECIFICATIONS

Voltage	90-264Vac
Frequency	47 to 63Hz
Input Current	0.5A max.
Inrush Current	Cold Start @25°C 50A max. @ 240Vac
Leakage Current	0.25mA max.

### OUTPUT SPECIFICATIONS

Hold-up Time	10ms typ. @115Vac
Short Circuit Protection	Hiccup Mode (Auto Recovery)
Over Voltage Protection	Hiccup Mode (Auto Recovery)
Temperature Coefficient	±0.05% / °C

### SAFETY AND EMISSION

Emission and Immunity	EN55032 Class B, FCC Part 15 Class B EN61000-6-3, EN61000-3-2, EN61000-3-3, EN55024, EN61204-3, EN61000-6-1
Safety	Class II, IEC60950-1, EN60950-1, UL60950-1

### GENERAL SPECIFICATIONS

Isolation	Input to output= 4,242VDC
Operating Temperature	-20-60°C (see derating curve)
Storage Temperature	-20-85°C
Humidity	93% RH max. Non condensing
Cooling	Natural Convection
Switching Frequency	Full Load, 115V / 85KHz Typical 230V / 65KHz Typical
MTBF ... MIL-HDBK-217F, GB, at 25°C/115VAC	200Khrs min.
Altitude	5000m
Dimensions	2.835 x 2.047 x 1.378 inches (72.00 x 52.00 x 35.00 mm))
Weight	140 g (0.33 Pounds)

### NOTE

1. Add a 0.1µF ceramic capacitor and a 10µF E.L. capacitor to output for ripple & noise measuring @20MHz BW.
2. Voltage setpoint at 60% full load.
3. Line regulation measured from 100Vac to 240VAC full load.
4. Load regulation measured from 60% to full load and from 60% to 20% load (60% +/- 40% load).
5. Average Efficiency measured at 25%, 50%, 75%, 100% load and input voltage is 115VAC / 230VAC.

# TR15RA SERIES

## 15 WATT, LEVEL VI EFFICIENCY

### Features

- ◆ Universal Input Range 90-264VAC
- ◆ Two Color Case
- ◆ Meets EN55032 Class “B”
- ◆ Continuous Short Circuit Protection
- ◆ Interchangeable AC Plugs
- ◆ Over Voltage Protection
- ◆ Meets CoC V5 Tier 2 & DoE Level VI (Output Cable Length  $\leq$  1800mm)



### Ordering information

TR15RAXXX	-XX	E	XX	-XX	-BK
Model No.	DC Plug Type	OVP	DC Cable Length and Type	Color of Overmold Case	
			01: 720mm	BE: Blue	
			02: 1220mm	GY: Gray	
			03: 1800mm	RD: Red	
			11: 720mm with Ferrite Core	PE: Purple	
			12: 1220mm with Ferrite Core	OE: Orange	
			13: 1800mm with Ferrite Core		
			* 18AWG / UL1185		

### Mechanical Dimensions

All Dimensions in Inches (mm)

Tolerance Inches: X.XXX $\pm$ 0.02  
Millimeters: X.XX $\pm$ 0.5

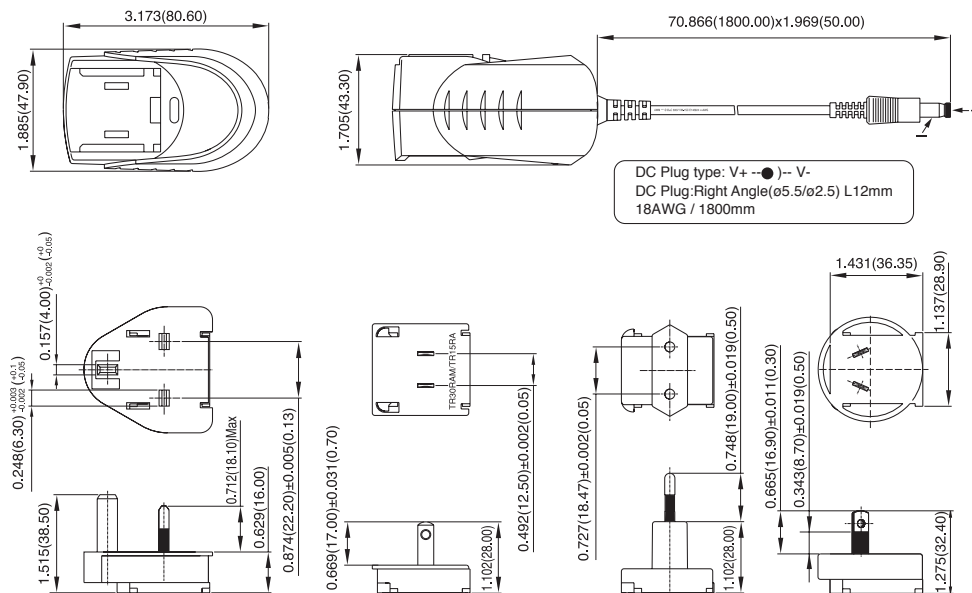

MODEL NUMBER	OUTPUT VOLTAGE	OUTPUT CURRENT	RIPPLE & NOISE (NOTE 1)	VOLTAGE ACCURACY (NOTE 2)	LINE REGULATION (NOTE 3)	CURRENT REGULATION (NOTE 4)	AVERAGE EFFICIENCY MIN. (NOTE 5)
TR15RA050	5 V	2.0 A	1%	$\pm$ 3%	$\pm$ 1%	$\pm$ 4%	79.01%
TR15RA059	5.9 V	1.7 A	1%	$\pm$ 2%	$\pm$ 1%	$\pm$ 3%	79.03%
TR15RA090	9 V	1.4 A	1%	$\pm$ 2%	$\pm$ 1%	$\pm$ 2%	83.55%
TR15RA120	12 V	1.1 A	1%	$\pm$ 2%	$\pm$ 1%	$\pm$ 2%	83.81%
TR15RA150	15 V	1.0 A	1%	$\pm$ 2%	$\pm$ 1%	$\pm$ 2%	84.51%
TR15RA180	18 V	0.83 A	1%	$\pm$ 2%	$\pm$ 1%	$\pm$ 2%	84.49%
TR15RA240	24 V	0.625 A	1%	$\pm$ 2%	$\pm$ 1%	$\pm$ 2%	84.51%

## Derating Curve

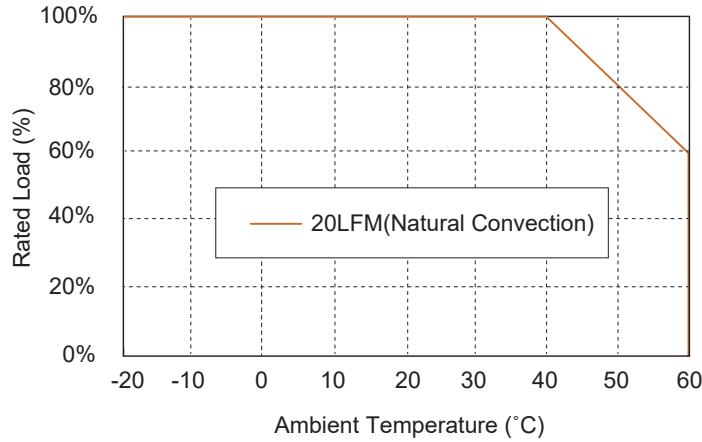

## Specifications

All Specifications Typical At Nominal Line, 75% Load and 25°C Unless Otherwise Noted

### INPUT SPECIFICATIONS

Voltage	90-264Vac, 120-370Vdc
Frequency	47 to 63Hz
Inrush Current	Cold Start @25°C 90A max. @ 240Vac
Leakage Current	0.25mA max.

### OUTPUT SPECIFICATIONS

Hold-up Time	10ms typ. @115Vac
Short Circuit Protection	Continuous (Auto Recovery) TVS
Over Voltage Protection	Component to Clamp
Temperature Coefficient	±0.05% / °C

### SAFETY AND EMISSION

Emission and Immunity	EN55032 Class B, EN61000-6-3, EN61000-3-2, EN61000-3-3, EN55024, EN61204-3, EN61000-6-1
Safety	Class II, IEC60950-1, EN60950-1, UL60950-1

### GENERAL SPECIFICATIONS

Isolation	Input to output= 4,242VDC
Operating Temperature	-20-60°C (see derating curve)
Storage Temperature	-20-85°C
Humidity	93% RH max. Non condensing
Cooling	Natural Convection
Switching Frequency	65KHz Typical
MTBF (MIL-HDBK-217F, GB, at 25°C /115VAC)	200Khrs min.
Altitude	2000m
Dimensions	3.173 x 1.885 x 1.705 inches (80.60 x 47.90 x 43.30 mm)
Weight	150 g (0.33 Pounds)

### NOTE

1. Add a 0.1µF ceramic capacitor and a 10µF E.L. capacitor to output for ripple & noise measuring @20MHz BW.
2. Voltage setpoint at 60% full load.
3. Line regulation measured from 100VAC to 240VAC full load.
4. Load regulation measured from 60% to full load and from 60% to 20% load (60% +/- 40% load).
5. "Various TR Series adapters are PSE certified. PSE certification alone is not sufficient for importation into Japan. A valid PSE mark must contain the name of the importer as shown in the example below. If PSE mark is required, the name of the registered importer must be supplied to Cincon on order placement. Product labels will not contain PSE mark if importer name is not supplied. Consult factory or local representative for details".



# TRH21A SERIES

## 20 WATT, LEVEL VI EFFICIENCY

### Features

- ◆ Universal Input Range 90-264VAC
  - ◆ Efficiency to 88%
  - ◆ Continuous Short Circuit Protection
  - ◆ Over Voltage Protection
  - ◆ No Load Input Power < 0.075W
  - ◆ Leakage Current < 0.25mA
  - ◆ IEC60950-1/EN60950-1/UL60950-1 ITE Approved
  - ◆ AC Inlet IEC320/C8
  - ◆ Meet CoC Tier 2 & DoE Level VI
- (TRH21A050: Length  $\leq$  1220mm 18AWG)  
 (TRH21A090, TRH21A120: Length  $\leq$  1800mm 18AWG)  
 (TRH21A150: Length  $\leq$  1800mm 20AWG)  
 (TRH21A180, TRH21A240: Length  $\leq$  1800mm 22AWG)



### Mechanical Dimensions

All Dimensions in Inches (mm)  
 Tolerance Inches: X.XXX $\pm$ 0.02  
 Millimeters: X.XX $\pm$ 0.5

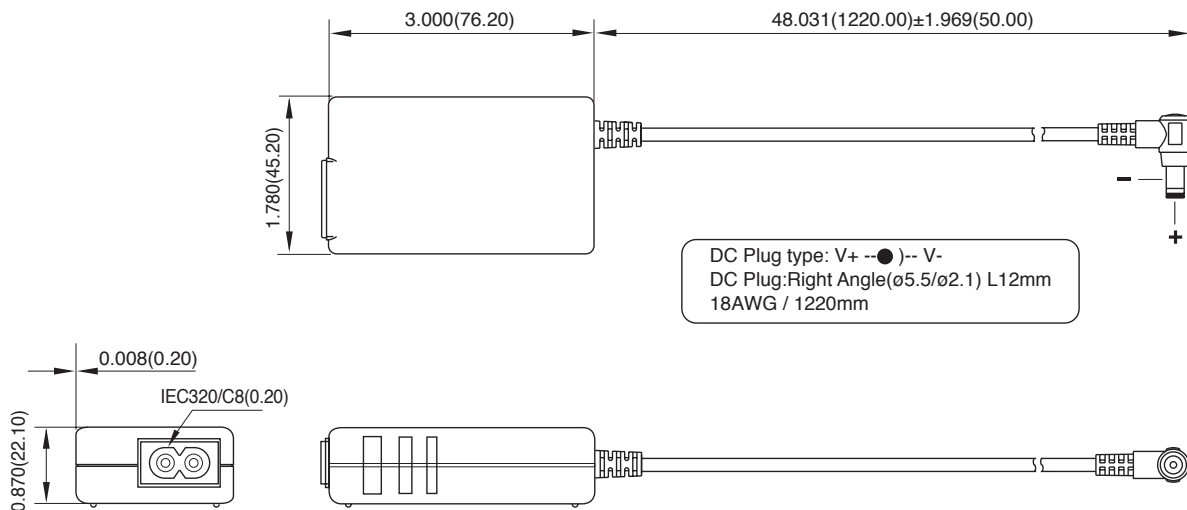

MODEL NUMBER	OUTPUT VOLTAGE	OUTPUT CURRENT	RIPPLE & NOISE (NOTE 2)	VOLTAGE ACCURACY (NOTE 1)	LINE REGULATION (NOTE 3)	LOAD REGULATION (NOTE 4)	EFFICIENCY (typ.) (NOTE 5)
TRH21A050	5 V	3.0 A	50 mV	$\pm$ 2%	$\pm$ 1%	$\pm$ 5%	82%
TRH21A090	9 V	2.3 A	50 mV	$\pm$ 2%	$\pm$ 1%	$\pm$ 4%	86.5%
TRH21A120	12 V	1.8 A	90 mV	$\pm$ 2%	$\pm$ 1%	$\pm$ 3%	86.5%
TRH21A150	15 V	1.4 A	100 mV	$\pm$ 2%	$\pm$ 1%	$\pm$ 3%	86.5%
TRH21A180	18 V	1.2 A	100 mV	$\pm$ 2%	$\pm$ 1%	$\pm$ 2%	87%
TRH21A240	24 V	0.9 A	100 mV	$\pm$ 2%	$\pm$ 1%	$\pm$ 2%	88%

## Derating Curve

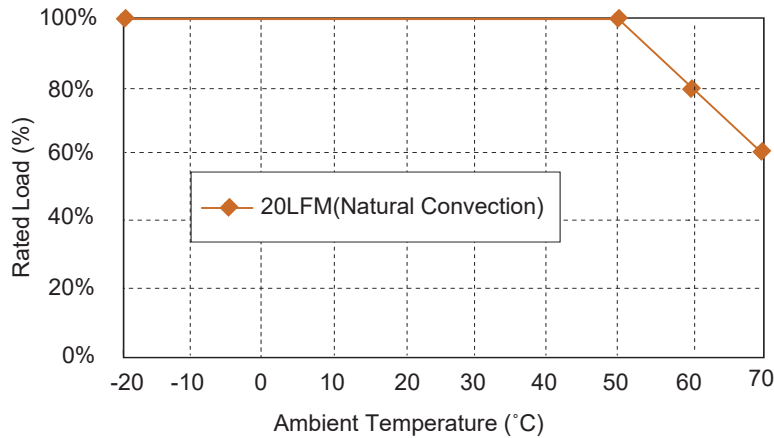

## Specifications

All Specifications Typical At Nominal Line, 75% Load and 25°C Unless Otherwise Noted

### INPUT SPECIFICATIONS

Voltage	90-264Vac
Frequency	47 to 63Hz
Input Current	0.3 to 0.5A
Inrush Current	Cold Start@25°C 50A max.@240Vac
Leakage Current	0.25mA max.

### OUTPUT SPECIFICATIONS

Voltage Accuracy	±2.0% max.
Line Regulation (note 3)	±1.0% max.
Load Regulation (note 4)	see table
Hold-up Time	8ms typ. @115Vac
Short Circuit Protection	Continuous
Over Voltage Protection(TVS)	115%-140% of nominal output voltage

### SAFETY AND EMISSION

Emissions	EN55032/CISPR Class B,
Safety Approvals	EN55024 IEC60950-1, EN60950-1, UL60950-1

### GENERAL SPECIFICATIONS

Isolation	Input to output= 4,000VAC
Efficiency	see table
Switching Frequency	65KHz typ.
Operating Temperature	-20-70°C (see derating curve)
Storage Temperature	-25-85°C
Cooling	Natural Convection
Humidity	93% RH max. Non condensing
MTBF .... MIL-STD-217F, GB, at 25°C/115VAC	400Khrs min.
Dimensions	3.000 x 1.780 x 0.870 inches (76.20 x 45.20 x 22.10 mm)
Weight	140 g (0.31Pounds)

### NOTE

1. Voltage accuracy is set of 60% rated load.
2. Add a 0.1μF ceramic capacitor and a 10μF E.L. capacitor to output for ripple & noise measuring @20MHz BW.
3. Line regulation is measured from high line to low line with full load.
4. Load regulation is measured from 60% to full load and from 60% to 20% load (60% +/- 40% load).
5. Typical efficiency at 230VAC and 75% load at 25°C.

# TRE25 SERIES

## 25W SWITCHING ADAPTER

### Features

- ◆ Miniature Size
- ◆ Universal Input: 90-264Vac
- ◆ Meets EN55032 Class B and CISPR/FCC Class B
- ◆ Continuous Short Circuit Protection
- ◆ Over Voltage Protection
- ◆ No Load Power Consumption<75mW
- ◆ Approved IEC62368-1, UL62368-1, EN62368-1
- ◆ Meet CoC V5 Tier 2 & DoE Level VI (Output Cable Length  $\leq$  1800mm) (TRE25050: Output Cable Length  $\leq$  1220mm)



### Ordering information

TRE25XXX - X	XX	G	XX
<b>Model No.</b>	<b>AC Plug Type</b>	<b>DC Plug Type</b>	<b>UL 1571 WITH OVP</b>
	A: USA 2 Pin E: Europe 2 Pin U: British 3 Pin		
			<b>DC Cable Length and Type</b>
			01: 720mm 02: 1220mm 03: 1800mm 11: 720mm with Ferrite Core 12: 1220mm with Ferrite Core 13: 1800mm with Ferrite Core * 20AWG / UL1571 or Equivalent * 16AWG / UL1571 for Vo:5V or Equivalent

### Mechanical Dimensions

All Dimensions are in inches[mm]  
Tolerance: Inches:X.XXX±0.02  
Millimeters:X.XX±0.5

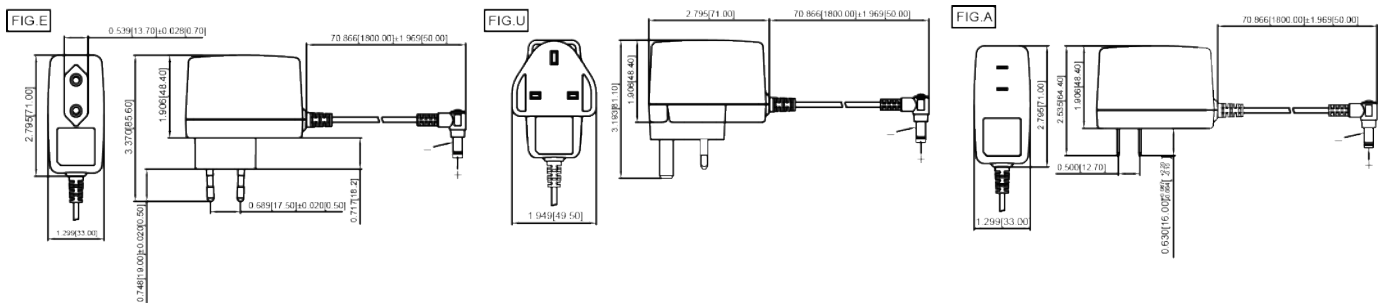

MODEL	OUTPUT VOLTAGE	OUTPUT CURRENT	RIPPLE & NOISE (NOTE 1)	VOLTAGE ACCURACY (NOTE 2)	LINE REGULATION (NOTE 3)	LOAD REGULATION (NOTE 4)	AVG.ERAGE EFF.min
TRE25050	5 V	4 A	50mVp-p	±2%	±1%	±6%	83.7%
TRE25120	12 V	2.1 A	1%	±2%	±1%	±5%	87.0%
TRE25150	15 V	1.67 A	1%	±2%	±1%	±3%	87.0%
TRE25180	18 V	1.4 A	1%	±2%	±1%	±2%	87.0%
TRE25240	24 V	1.05A	1%	±2%	±1%	±2%	87.0%



## Derating Curve

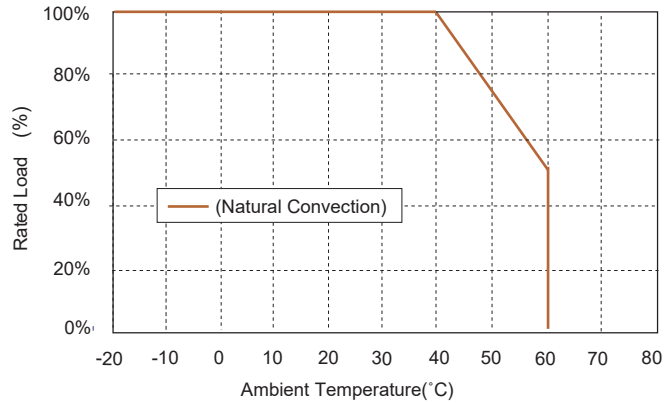

## Specifications

All Specifications Typical At Nominal Line, Full Load, and 25°C Unless Otherwise Noted

### INPUT SPECIFICATIONS

Voltage	90-264Vac, 120-370Vdc
Frequency	47 to 63Hz
Input Current	0.7A max
Inrush Current	60A max. @240Vac
Conducted EMI	CISPR/FCC Class B
Leakage Current	0.25mA max.

### OUTPUT SPECIFICATIONS

Holdup Time	10ms typ. @115Vac
Short Circuit Protection	Continuous(Auto Recovery)
Over Voltage Protection	IC Component to Clamp
Temperature Coefficient	±0.05% / °C

### SAFETY AND EMISSION

Emission and Immunity	EN55032 Class B, FCC Part 15 Class B EN61000-6-3, EN61000-3-2, EN61000-3-3 EN55024, EN61204-3, EN61000-6-1
Safety	Class II, IEC62368-1/60950-1, UL62368-1/60950-1 EN62368-1/60950-1

### GENERAL SPECIFICATIONS

Isolation	Input to output = 3,000VAC
Operating Temperature	-20-60°C(see derating curve)
Storage Temperature	-20-85°C
Humidity	93% RH max. Non condensing
Cooling	Natural Convection
Switching Frequency	65KHz typ
MTBF	MIL-HDBK-217F, GB, 25°C/115VAC 330K hrs min.
Altitude	3000m
Life time	Ambient 40degC 75% Load >3years
Dimensions	2.795x1.906x1.299Inches (71.00x48.4x33.00mm)
Weight	140g(0.31 Pounds)

### NOTE

1. Add a 0.1uF ceramic capacitor and a 10uF E.L. capacitor to output for ripple & noise measuring @20MHz BW.
2. Voltage setpoint at 60% full load.
3. Line regulation measured from 100Vac to 240Vac, full load.
4. Load regulation measured from 60% to 100% full load and from 60% to 20% load (60% +/- 40% full load).

# TRE25R SERIES

## 25W SWITCHING ADAPTER

### Features

- ◆ Miniature Size
- ◆ Universal Input: 90-264Vac
- ◆ Interchangeable AC Plugs
- ◆ Meets EN55032 Class B and CISPR/FCC Class B
- ◆ Continuous Short Circuit Protection
- ◆ Over Voltage Protection
- ◆ No Load Power Consumption < 75mW
- ◆ Approved IEC62368-1, UL62368-1, EN62368-1
- ◆ Meet CoC V5 Tier 2 & DoE Level VI  
(Output Cable Length  $\leq$  1800mm)  
(TRE25R050: Output Cable Length  $\leq$  1220mm)



### Ordering information

TRE25RXXX XX G XX  
 Model No. DC Plug Type UL 1571 WITH OVP. DC Cable Length and Type  
 01: 720mm  
 02: 1220mm  
 03: 1800mm  
 11: 720mm with Ferrite Core  
 12: 1220mm with Ferrite Core  
 13: 1800mm with Ferrite Core  
 \* 20AWG / UL1571 or Equivalent  
 \* 16AWG / UL1571 for Vo:5V or Equivalent

### Mechanical Dimensions

All Dimensions are in inches(mm)  
 Tolerance: Inches: X.XXX $\pm$ 0.02  
 Millimeters: X.XX $\pm$ 0.5

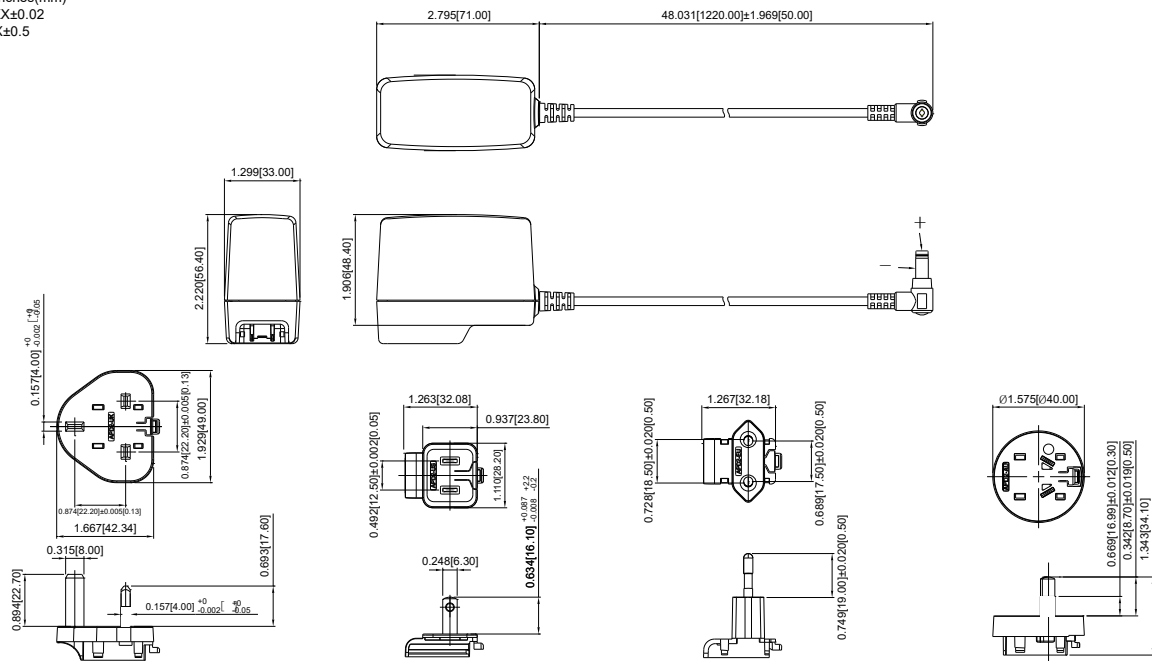

MODEL NUMBER	OUTPUT VOLTAGE	OUTPUT CURRENT	RIPPLE & NOISE (NOTE 1)	VOLTAGE ACCURACY (NOTE 2)	LINE REGULATION (NOTE 3)	LOAD REGULATION (NOTE 4)	AVG. ERAGE EFF. min
TRE25R050	5 V	4 A	50mVp-p	$\pm$ 2%	$\pm$ 1%	$\pm$ 6%	83.7%
TRE25R120	12 V	2.1 A	1%	$\pm$ 2%	$\pm$ 1%	$\pm$ 5%	87.0%
TRE25R150	15 V	1.67 A	1%	$\pm$ 2%	$\pm$ 1%	$\pm$ 3%	87.0%
TRE25R180	18 V	1.4 A	1%	$\pm$ 2%	$\pm$ 1%	$\pm$ 2%	87.0%
TRE25R240	24 V	1.05 A	1%	$\pm$ 2%	$\pm$ 1%	$\pm$ 2%	87.0%

## Derating Curve

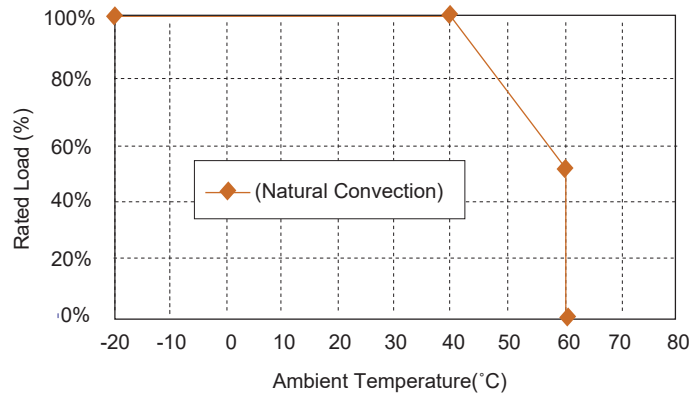

## Specifications

All Specifications Typical At Nominal Line, Full Load, and 25°C Unless Otherwise Noted

### INPUT SPECIFICATIONS

Voltage	90-264Vac, 120-370Vdc
Frequency	47 to 63Hz
Input Current	0.7A max.
Inrush Current	60A max. @240Vac
Conducted EMI	CISPR/FCC Class B
Leakage Current	0.25mA max.

### OUTPUT SPECIFICATIONS

Holdup Time	10ms typ. @115Vac
Short Circuit Protection	Hiccup Mode (Auto Recovery)
Over Voltage Protection	IC Component to Clamp
Temperature Coefficient	±0.05%/°C

### SAFETY AND EMISSION

Emission and Immunity	EN55032 Class B, FCC Part 15 Class B EN61000-6-3, EN61000-3-2, EN61000-3-3 EN55024, EN61204-3, EN61000-6-1 Class II, IEC62368-1/60950-1 UL62368-1/60950-1 EN62368-1/60950-1
Safety	

### GENERAL SPECIFICATIONS

Isolation	Input to output 3,000VAC
Operating Temperature	-20-60 °C(see derating curve)
Storage Temperature	-20-85 °C
Humidity	93% RH max. Non condensing
Cooling	Natural Convection
Switching Frequency	65KHz typ.
MTBF	MIL-HDBK-217F, GB, 25°C/115VAC 300Khrs min.
Altitude	3000m
Life time	Ambient 40degC 75% Load >3years
Dimensions	2.835x2.244x1.299Inches (72.00x57.0x33.00mm)
Weight	140g(0.31 Pounds)

### NOTE

1. Add a 0.1uF ceramic capacitor and a 10uF E.L. capacitor to output for ripple & noise measuring @20MHz BW.
2. Voltage setpoint at 60% full load.
3. Line regulation measured from 100Vac to 240Vac, full load.
4. Load regulation measured from 60% to 100% full load and from 60% to 20% load (60% +/- 40% full load).

# TRE25RD SERIES

## 25W SWITCHING ADAPTER

### Features

- ◆ Miniature Size
- ◆ Universal Input: 90-264Vac
- ◆ Interchangeable AC Plugs
- ◆ Meets EN55032 Class B and CISPR/FCC Class B
- ◆ Continuous Short Circuit Protection
- ◆ Over Voltage Protection
- ◆ No Load Power Consumption < 75mW
- ◆ Approved IEC62368-1, UL62368-1, EN62368-1
- ◆ Meet CoC V5 Tier 2 & DoE Level VI  
(Output Cable Length  $\leq$  1800mm)  
(TRE25RD050: Output Cable Length  $\leq$  1220mm)



### Ordering information

TRE25RXXX	XX	G	XX
Model No.	DC Plug Type	UL 1571 WITH OVP.	DC Cable Length and Type
			01: 720mm
			02: 1220mm
			03: 1800mm
			11: 720mm with Ferrite Core
			12: 1220mm with Ferrite Core
			13: 1800mm with Ferrite Core
			* 20AWG / UL1571 or Equivalent
			* 16AWG / UL1571 for Vo:5V or Equivalent

### Mechanical Dimensions

All Dimensions are in inches(mm)  
Tolerance: Inches: X.XXX $\pm$ 0.02  
Millimeters: X.XX $\pm$ 0.5  
UNIT: inches(mm)

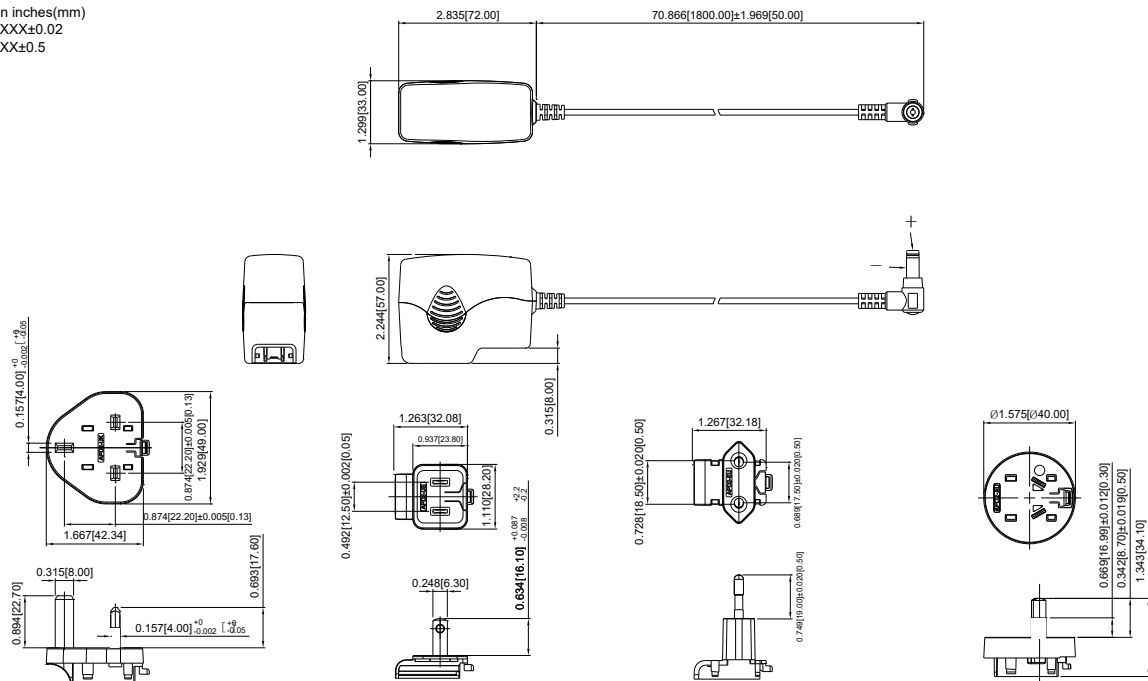

MODEL NUMBER	OUTPUT VOLTAGE	OUTPUT CURRENT	RIPPLE & NOISE (NOTE 1)	VOLTAGE ACCURACY (NOTE 2)	LINE REGULATION (NOTE 3)	LOAD REGULATION (NOTE 4)	AVG. ERAGE EFF. min
TRE25R050	5 V	4 A	50mVp-p	$\pm$ 2%	$\pm$ 1%	$\pm$ 6%	83.7%
TRE25R120	12 V	2.1 A	1%	$\pm$ 2%	$\pm$ 1%	$\pm$ 5%	87.0%
TRE25R150	15 V	1.67 A	1%	$\pm$ 2%	$\pm$ 1%	$\pm$ 3%	87.0%
TRE25R180	18 V	1.4 A	1%	$\pm$ 2%	$\pm$ 1%	$\pm$ 2%	87.0%
TRE25R240	24 V	1.05 A	1%	$\pm$ 2%	$\pm$ 1%	$\pm$ 2%	87.0%

## Derating Curve

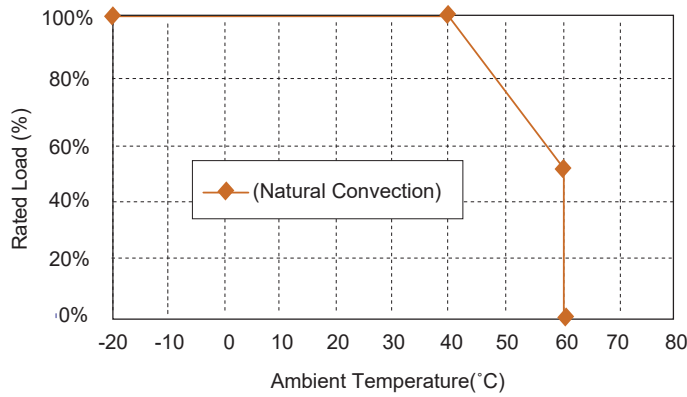

## Specifications

All Specifications Typical At Nominal Line, Full Load, and 25°C Unless Otherwise Noted

### INPUT SPECIFICATIONS

Voltage	90-264Vac, 120-370Vdc
Frequency	47 to 63Hz
Input Current	0.7A max.
Inrush Current	60A max. @240Vac
Conducted EMI	CISPR/FCC Class B
Leakage Current	0.25mA max.

### OUTPUT SPECIFICATIONS

Holdup Time	10ms typ. @115Vac
Short Circuit Protection	Continuous(Auto Recovery)
Over Voltage Protection	IC Component to Clamp
Temperature Coefficient	±0.05%/°C

### SAFETY AND EMISSION

Emission and Immunity	EN55032 Class B, FCC Part 15 Class B EN61000-6-3, EN61000-3-2, EN61000-3-3 EN55024, EN61204-3, EN61000-6-1
Safety	Class II, IEC62368-1/60950-1 UL62368-1/60950-1 EN62368-1/60950-1

### GENERAL SPECIFICATIONS

Isolation	Input to output 3000VAC
Operating Temperature	-20-60°C(see derating curve)
Storage Temperature	-20-85°C
Humidity	93% RH max. Non condensing
Cooling	Natural Convection
Switching Frequency	65KHz typ.
MTBF	MIL-HDBK-217F, GB, 25°C/115VAC 300Khrs min.
Altitude	3000m
Life time	Ambient 40degC 75% Load >3years
Dimensions	2.835x2.244x1.299Inches (72.00x57.0x33.00mm)
Weight	140g(0.31 Pounds)

### NOTE

1. Add a 0.1uF ceramic capacitor and a 10uF E.L. capacitor to output for ripple & noise measuring @20MHz BW.
2. Voltage setpoint at 60% full load.
3. Line regulation measured from 100Vac to 240Vac, full load.
4. Load regulation measured from 60% to 100% full load and from 60% to 20% load (60% +/- 40% full load).

# TRH25 SERIES

## 25 WATT, LEVEL VI EFFICIENCY

### Features

- ◆ Miniature Size
- ◆ Universal Input: 90-264VAC
- ◆ EMI Meets EN55032 Class B and CISPR/FCC Class B
- ◆ Continuous Short Circuit Protection
- ◆ Over Voltage Protection
- ◆ No Load Power Consumption < 75mW
- ◆ Meet CoC V5 Tier 2 & DoE Level VI  
(Output Cable Length  $\leq$  1800mm)  
(TRH25033: Output Cable Length  $\leq$  720mm)  
(TRH25050: Output Cable Length  $\leq$  1220mm)

### Ordering information

TRH25 XXX - Model No.	X AC Plug Type A: USA 2 Pin E: Europe 2 Pin U: British 3 Pin S: Australia 2 Pin	-X DC Plug Type	E OVP	XX DC Cable Length and Type 01: 720mm 02: 1220mm 03: 1800mm 11: 720mm with Ferrite Core 12: 1220mm with Ferrite Core 13: 1800mm with Ferrite Core * 18AWG / UL1185 * 16AWG / UL1185 for Vo:5V,3.3V * 20AWG / UL1185 for Vo:15V * 22AWG / UL1185 for Vo:18V * 24AWG / UL1185 for 24V
-----------------------	---	-----------------	-------	--



### Mechanical Dimensions

All Dimensions in Inches (mm)  
Tolerance Inches: X.XXX $\pm$ 0.02  
Millimeters: X.XX $\pm$ 0.5

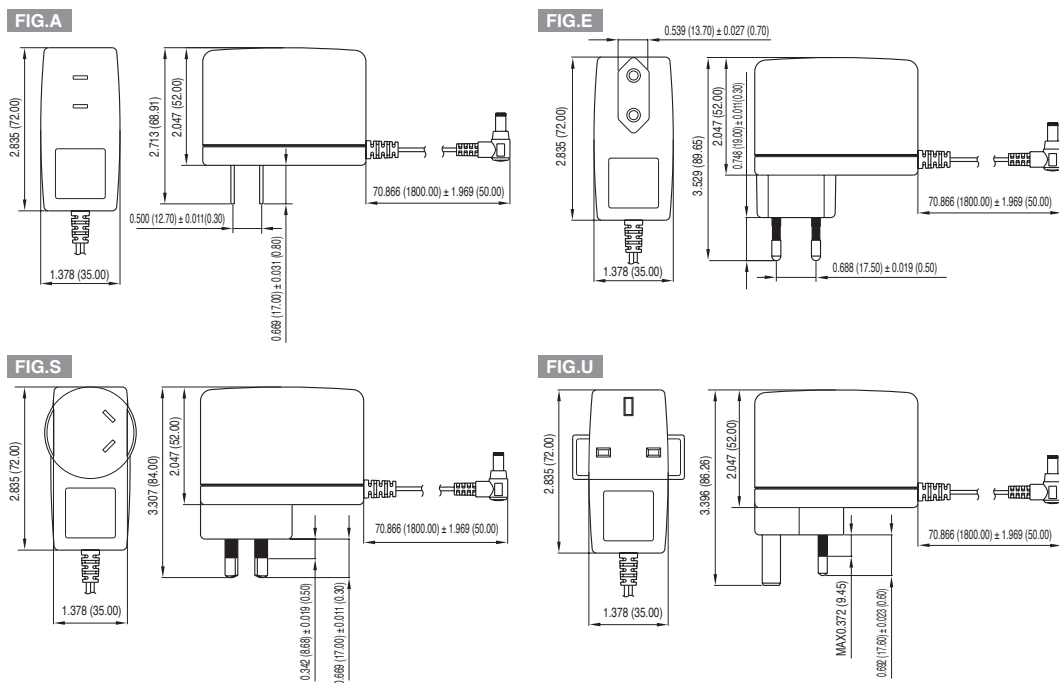

MODEL NUMBER	OUTPUT VOLTAGE	OUTPUT CURRENT	RIPPLE & NOISE (NOTE 1)	VOLTAGE ACCURACY (NOTE 2)	LINE REGULATION (NOTE 3)	CURRENT REGULATION (NOTE 4)	AVERAGE EFFICIENCY MIN. (NOTE 5)
TRH25033	3.3 V	4.0 A	50mVp-p	$\pm$ 2%	$\pm$ 1%	$\pm$ 6%	80.97%
TRH25050	5 V	4.0 A	1%	$\pm$ 2%	$\pm$ 1%	$\pm$ 6%	83.69%
TRH25120	12 V	2.1 A	1%	$\pm$ 2%	$\pm$ 1%	$\pm$ 5%	87.02%
TRH25150	15 V	1.67 A	1%	$\pm$ 2%	$\pm$ 1%	$\pm$ 3%	86.99%
TRH25180	18 V	1.4 A	1%	$\pm$ 2%	$\pm$ 1%	$\pm$ 2%	87.02%
TRH25240	24 V	1.05 A	1%	$\pm$ 2%	$\pm$ 1%	$\pm$ 2%	87.02%

## Derating Curve

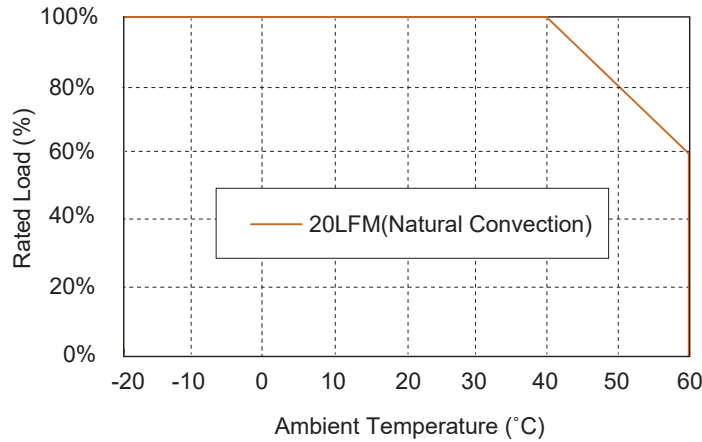

## Specifications

All Specifications Typical At Nominal Line, 75% Load and 25°C Unless Otherwise Noted

### INPUT SPECIFICATIONS

Voltage	90-264Vac, 120-270Vdc
Frequency	47 to 63Hz
Input Current	0.7A max
Inrush Current	Cold Start @25°C 60A max. @ 240Vac
Leakage Current	0.25mA max.
Conducted EMI	CISPR/FCC Class B

### OUTPUT SPECIFICATIONS

Hold-up Time	10ms typ. @115Vac
Short Circuit Protection	Continuous (Auto Recovery)
Over Voltage Protection	TVS Component to Clamp
Temperature Coefficient	±0.05% / °C

### SAFETY AND EMISSION

Emission and Immunity	EN55032 Class B, FCC Part 15 Class B EN61000-6-3, EN61000-3-2, EN61000-3-3, EN55024, EN61204-3, EN61000-6-1
Safety	Class II, IEC60950-1, EN60950-1, UL60950-1

### GENERAL SPECIFICATIONS

Isolation	Input to output= 4,242VDC
Operating Temperature	-20-60°C (see derating curve)
Storage Temperature	-20-85°C
Humidity	93% RH max. Non condensing
Cooling	Natural Convection
Switching Frequency	67KHz Typical
MTBF	MIL-HDBK-217F, GB,25°C /115VAC 425Khrs min.
Altitude	2000m
Dimensions	2.835 x2.047 x 1.378 inches (72.00 x 52.00 x 35.00 mm)
Weight	140 g (0.31 Pounds)

### NOTE

1. Add a 0.1µF ceramic capacitor and a 10µF E.L. capacitor to output for ripple & noise measuring @20MHz BW.
2. Voltage setpoint at 60% full load.
3. Line regulation measured from 100VAC to 240VAC full load.
4. Load regulation measured from 60% to full load and from 60% to 20% load (60% +/- 40% load).



# TRG30RV SERIES

## 30 WATT, LEVEL VI EFFICIENCY

### Features

- ◆ Universal Input Range 90-264VAC
- ◆ Interchangeable AC Plugs
- ◆ Meets EN61204-3 Class B and CISPR/FCC Class B
- ◆ Continuous Short Circuit Protection
- ◆ Over Voltage Protection
- ◆ Meets CoC Tier 2 & DoE Level VI  
(Output Cable Length  $\leq$  1800mm)
- ◆ No Load Power Consumption < 75mW

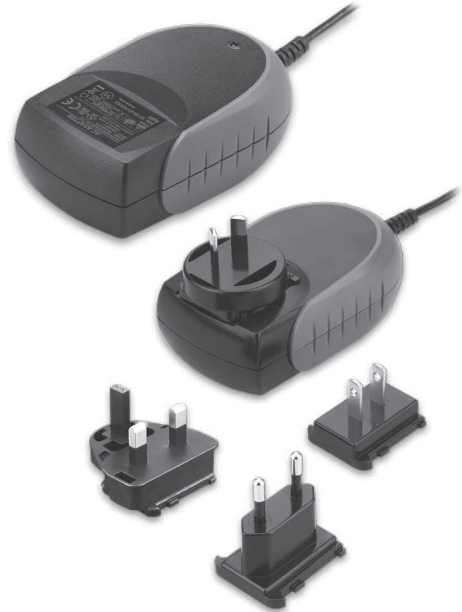

### Ordering information

TRG30RXXXV Model No.	-XX DC Plug Type	E OVP	XX DC Cable Length and Type 01: 720mm 02: 1220mm 03: 1800mm 11: 720mm with Ferrite Core 12: 1220mm with Ferrite Core 13: 1800mm with Ferrite Core * 18AWG / UL1185 * 16AWG / UL1185 for 5V - 9V	-XX Color of Overmold Case BE: Blue GY: Gray RD: Red PE: Purple OR: Orange	-BK
-------------------------	---------------------	----------	--	--	-----

### Mechanical Dimensions

All Dimensions in Inches (mm)  
Tolerance Inches: X.XXX $\pm$ 0.02  
Millimeters: X.XX $\pm$ 0.5

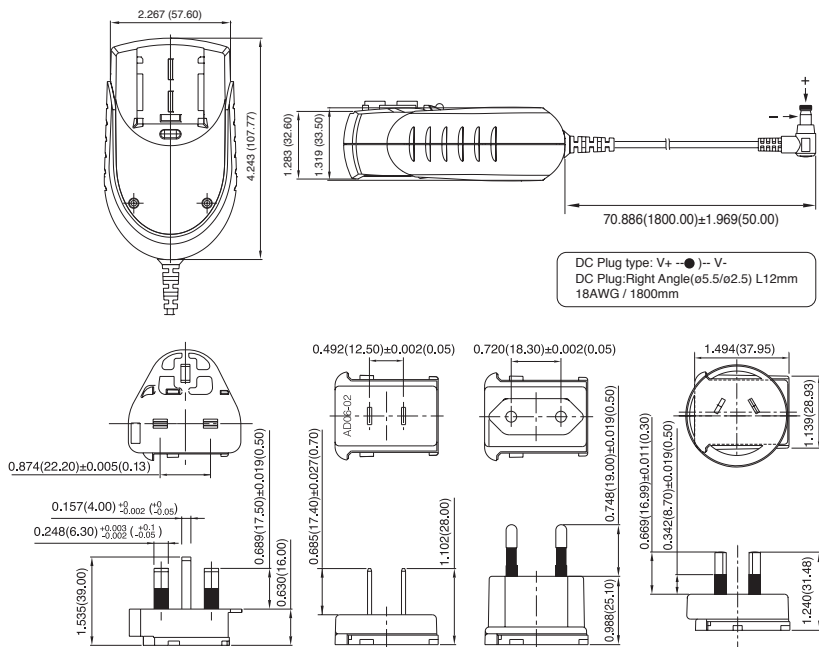

MODEL NUMBER	OUTPUT VOLTAGE	OUTPUT CURRENT	RIPPLE & NOISE (NOTE 1)	VOLTAGE ACCURACY (NOTE 2)	LINE REGULATION (NOTE 3)	CURRENT REGULATION (NOTE 4)	AVERAGE EFFICIENCY MIN. (NOTE 5)
TRG30R050V	5 V	4.0 A	50mVp-p	$\pm$ 2%	$\pm$ 1%	$\pm$ 6%	83.69%
TRG30R090V	9 V	3.0 A	90mVp-p	$\pm$ 2%	$\pm$ 1%	$\pm$ 3%	87.30%
TRG30R120V	12 V	2.5 A	100mVp-p	$\pm$ 2%	$\pm$ 1%	$\pm$ 2%	87.70%
TRG30R150V	15 V	2.0 A	100mVp-p	$\pm$ 2%	$\pm$ 1%	$\pm$ 2%	87.70%
TRG30R180V	18 V	1.67 A	100mVp-p	$\pm$ 2%	$\pm$ 1%	$\pm$ 2%	87.70%
TRG30R240V	24 V	1.25 A	100mVp-p	$\pm$ 2%	$\pm$ 1%	$\pm$ 2%	87.70%

## Derating Curve

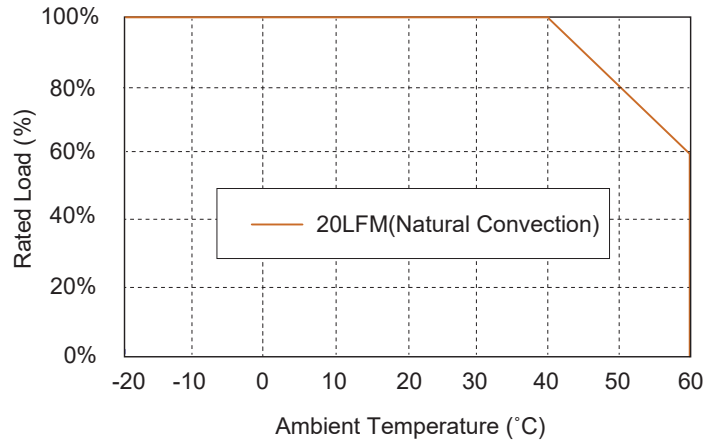

## Specifications

All Specifications Typical At Nominal Line, 75% Load and 25°C Unless Otherwise Noted

### INPUT SPECIFICATIONS

Voltage	90-264Vac
Frequency	47 to 63Hz
Input Current	0.8A max
Inrush Current	Cold Start @25°C 100A max. @ 240Vac
Leakage Current	0.25mA max.

### OUTPUT SPECIFICATIONS

Hold-up Time	10ms typ. @115Vac
Short Circuit Protection	Hiccup Mode (Auto Recovery)
Over Voltage Protection	Latch

### SAFETY AND EMISSION

Emission and Immunity	EN61204-3, EN61000-3-2, EN61000-3-3, FCC CFR Title 47 Part 15 Subpart B
Safety	Class II, IEC60950-1, UL60950-1, EN60950-1

### GENERAL SPECIFICATIONS

Isolation	Input to output= 4,242VDC
Operating Temperature	-20-60°C (see derating curve)
Storage Temperature	-20-85°C
Humidity	93% RH max. Non condensing
Cooling	Natural Convection
Switching Frequency	70KHz Typical
MTBF ..... MIL-HDBK-217F, GB, 25°C/115VAC	200Khrs min.
Altitude	5000m
Dimensions	4.243 x 2.267 x 1.319 inches (107.77 x 57.60 x 33.50 mm)
Weight	300 g (0.66 Pounds)

### NOTE

1. Add a 0.1µF ceramic capacitor and a 10µF E.L. capacitor to output for ripple & noise measuring @20MHz BW.
2. Voltage setpoint at 60% full load.
3. Line regulation measured from 100VAC to 240VAC full load.
4. Load regulation measured from 60% to full load and from 60% to 20% load (60% +/- 40% load).
5. Average Efficiency measured at 25%, 50%, 75%, 100% load and input voltage is 115Vac / 230Vac.

# TRG30RAV SERIES

## 30 WATT, LEVEL VI EFFICIENCY

### Features

- ◆ Universal Input Range 90-264VAC
- ◆ Interchangeable AC Plugs
- ◆ Meets EN61204-3 Class B and CISPR/FCC Class B
- ◆ Continuous Short Circuit Protection
- ◆ Over Voltage Protection
- ◆ Meets CoC Tier 2 & DoE Level VI (Output Cable Length  $\leq$  1800mm)
- ◆ No Load Power Consumption < 75mW



### Ordering information

TRG30RAXXXV	-XX	E	XX	-XX	-BK
Model No.	DC Plug Type	OVP	DC Cable Length and Type	Color of Overmold Case	
			01: 720mm	BE: Blue	
			02: 1220mm	GY: Gray	
			03: 1800mm	RD: Red	
			11: 720mm with Ferrite Core	PE: Purple	
			12: 1220mm with Ferrite Core	OR: Orange	
			13: 1800mm with Ferrite Core		
			* 18AWG / UL1185		
			* 16AWG / UL1185 for 5V - 9V		

### Mechanical Dimensions

All Dimensions in Inches (mm)  
 Tolerance Inches: X.XXX $\pm$ 0.02  
 Millimeters: X.XX $\pm$ 0.5

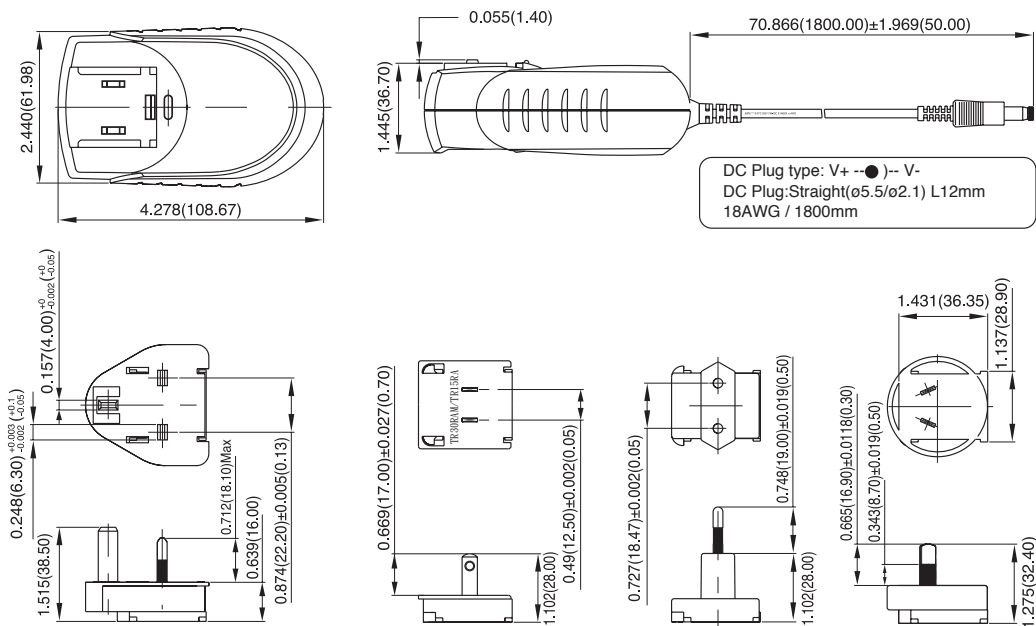

MODEL NUMBER	OUTPUT VOLTAGE	OUTPUT CURRENT	RIPPLE & NOISE (NOTE 1)	VOLTAGE ACCURACY (NOTE 2)	LINE REGULATION (NOTE 3)	LOAD REGULATION (NOTE 4)	AVERAGE EFFICIENCY MIN. (NOTE 5)
TRG30RA050V	5 V	4.0 A	50mVp-p	$\pm$ 2%	$\pm$ 1%	$\pm$ 6%	83.69%
TRG30RA090V	9 V	3.0 A	90mVp-p	$\pm$ 2%	$\pm$ 1%	$\pm$ 3%	87.30%
TRG30RA120V	12 V	2.5 A	100mVp-p	$\pm$ 2%	$\pm$ 1%	$\pm$ 2%	87.70%
TRG30RA150V	15 V	2.0 A	100mVp-p	$\pm$ 2%	$\pm$ 1%	$\pm$ 2%	87.70%
TRG30RA180V	18 V	1.67 A	100mVp-p	$\pm$ 2%	$\pm$ 1%	$\pm$ 2%	87.70%
TRG30RA240V	24 V	1.25 A	100mVp-p	$\pm$ 2%	$\pm$ 1%	$\pm$ 2%	87.70%

## Derating Curve

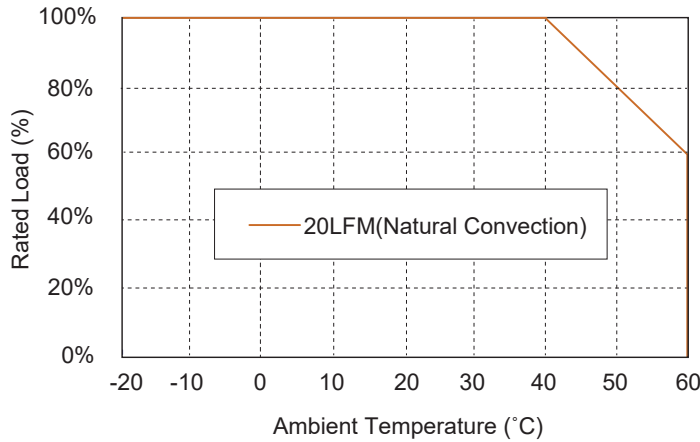

## Specifications

All Specifications Typical At Nominal Line, 75% Load and 25°C Unless Otherwise Noted

### INPUT SPECIFICATIONS

Voltage	90-264Vac
Frequency	47 to 63Hz
Input Current	0.8A max
Inrush Current	Cold Start @25°C 100A max. @ 240Vac
Leakage Current	0.25mA max.

### OUTPUT SPECIFICATIONS

Hold-up Time	10ms typ. @115Vac
Short Circuit Protection	Hiccup Mode (Auto Recovery)
Over Voltage Protection	Latch

### SAFETY AND EMISSION

Emission and Immunity	EN61204-3, EN61000-3-2, EN61000-3-3 FCC CFR Title 47 Part 15 Subpart B
Safety	Class II, IEC60950-1, UL60950-1, EN60950-1

### GENERAL SPECIFICATIONS

Isolation	Input to output= 4,242VDC
Operating Temperature	-20-60°C (see derating curve)
Storage Temperature	-20-85°C
Humidity	93% RH max. Non condensing
Cooling	Natural Convection
Switching Frequency	70KHz Typical
MTBF ..... MIL-HDBK-217F, GB, 25°C/115VAC	200Khrs min.
Altitude	5000m
Dimensions	4.278x2.440x1.445 inches (108.67x61.98x36.70mm)
Weight	300 g (0.66 Pounds)

### NOTE

1. Add a 0.1µF ceramic capacitor and a 10µF E.L. capacitor to output for ripple & noise measuring @20MHz BW.
2. Voltage setpoint at 60% full load.
3. Line regulation measured from 100VAC to 240VAC full load.
4. Load regulation measured from 60% to full load and from 60% to 20% load (60% +/- 40% load).
5. Average Efficiency measured at 25%, 50%, 75%, 100% load and input voltage is 115Vac / 230Vac.

# TRE36 SERIES

## 36W SWITCHING ADAPTER

### Features

- ◆ Universal Input Range 90-264VAC
- ◆ Meets EN55032 Class B and CISPR/FCC Class B
- ◆ Approved IEC62368-1, UL62368-1, EN62368-1
- ◆ Continuous Short Circuit Protection
- ◆ Over Voltage Protection
- ◆ Meet CoC Tier 2 & DoE Level VI  
(Output Cable Length  $\leq$  1800mm)  
(TRE36A050: Output Cable Length  $\leq$  1220mm)
- ◆ No Load Power Consumption < 75mW
- ◆ Class II



### Ordering information

TRE36AXXX Model No.	XX DC Plug Type	X G: UL1571 WITH OVP E: UL1185 WITH OVP * 16AWG / UL1571 or Equivalent for Vo: 5V * 18AWG / UL1571 or Equivalent for Vo: 9V, 12V, 13.5V * 20AWG / UL1571 or Equivalent for Vo: 15V, 18V, 24V * 20AWG / UL1185 or Equivalent for Vo: 36V, 48V	XX DC Cable Length and Type 01: 720mm 02: 1220mm 03: 1800mm 11: 720mm with Ferrite Core 12: 1220mm with Ferrite Core 13: 1800mm with Ferrite Core
------------------------	--------------------	--	--

### Mechanical Dimensions

All Dimensions are in inches[mm]  
Tolerance:Inches:X.XXX $\pm$ 0.02  
Millimeters:X.XX $\pm$ 0.5

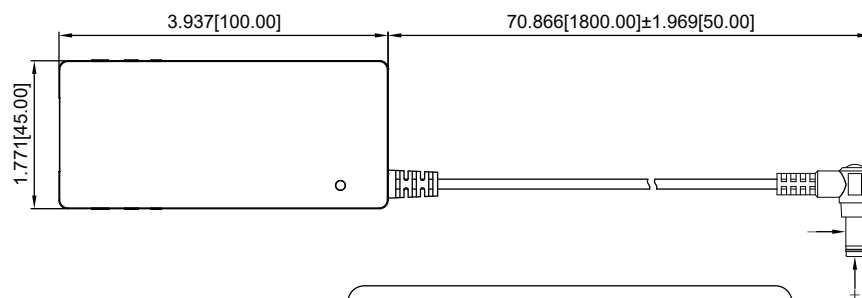

DC Plug type: V+ —●— V-  
DC Plug :Right Angle( $\psi$ 5.5/ $\psi$ 2.1)L12mm  
20AWG / 1800mm

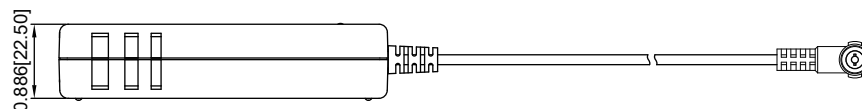
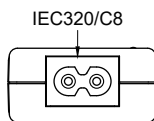

MODEL	OUTPUT VOLTAGE	OUTPUT CURRENT	RIPPLE& NOISE (NOTE 1)	VOLTAGE ACCURACY (NOTE 2)	LINE REGULATION (NOTE 3)	LOAD REGULATION (NOTE 4)	% EFF (Typ.) (NOTE 5)
TRE36A050	5 V	5.0 A	100mVp-p	$\pm$ 2%	$\pm$ 1%	$\pm$ 6%	85%
TRE36A090	9 V	3.3 A	120mVp-p	$\pm$ 2%	$\pm$ 1%	$\pm$ 4%	88%
TRE36A120	12 V	2.5 A	120mVp-p	$\pm$ 2%	$\pm$ 1%	$\pm$ 2%	89%
TRE36A135	13.5 V	2.4 A	130mVp-p	$\pm$ 2%	$\pm$ 1%	$\pm$ 2%	89%
TRE36A150	15 V	2.4 A	150mVp-p	$\pm$ 2%	$\pm$ 1%	$\pm$ 2%	89%
TRE36A180	18 V	2.0 A	180mVp-p	$\pm$ 2%	$\pm$ 1%	$\pm$ 2%	89%
TRE36A240	24 V	1.5 A	240mVp-p	$\pm$ 2%	$\pm$ 1%	$\pm$ 2%	89%
TRE36A360	36 V	1.0 A	360mVp-p	$\pm$ 2%	$\pm$ 1%	$\pm$ 2%	89%
TRE36A480	48 V	0.75 A	480mVp-p	$\pm$ 2%	$\pm$ 1%	$\pm$ 2%	89%

## Derating Curve

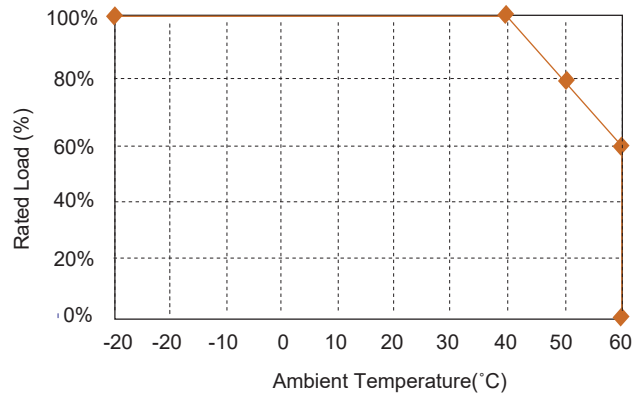

## Specifications

All Specifications Typical At Nominal Line, Full Load, and 25°C Unless Otherwise Noted

### INPUT SPECIFICATIONS

Voltage	90-264Vac
Frequency	47 to 63Hz
Input Current	0.9A max.
Inrush Current	Cold start@25°C 100A max. @240Vac
Leakage Current	0.25mA max.

### OUTPUT SPECIFICATIONS

Holdup Time	10ms typ. @115Vac
Short Circuit Protection	Hiccup Mode Continuous(Auto Recovery)
Over Voltage Protection	IC Component to Clamp(Auto Recovery)
Temperature Coefficient	±0.05%/°C

### SAFETY AND EMISSION

Emission and Immunity	EN55032 Class B, FCC Part 15 Class B EN61000-6-1, EN61000-6-2, EN61000-6-3, EN61000-6-4 EN55024, EN61204-3
Safety	Class II, IEC62368-1/60950-1 UL62368-1/60950-1 EN62368-1/60950-1

### GENERAL SPECIFICATIONS

Isolation	Input to output 3,000VAC
Operating Temperature	-30 -60°C(see derating curve)
Storage Temperature	-30-85°C
Humidity	93% RH max. Non condensing
Cooling	Natural Convection
Switching Frequency	65KHz typ.
MTBF	MIL-HDBK-217F, GB, 25°C/115VAC 860Khrs max.
Altitude	5000m
Dimensions	3.937x1.771x0.886 inches (100.00x45.00x22.50mm)
Weight	150g(0.33 Pounds)

### NOTE

1. Add a 0.1uF ceramic capacitor and a 10uF E.L. capacitor to output for ripple & noise measuring @20MHz BW.
2. Voltage setpoint at 60% full load.
3. Line regulation is measured from 100Vac to 240Vac full load.
4. Load regulation is measured from 60% to full load and from 60% to 20% load (60% +/- 40% load).
5. Efficiency measured at 75% load and input voltage is 230Vac.

# TRG36A SERIES

## 36 WATT, LEVEL VI EFFICIENCY

### Features

- ◆ Universal Input Range 90-264VAC
- ◆ Meets EN55032 Class “B” and CISPR/FCC Class B
- ◆ Continuous Short Circuit Protection
- ◆ Leakage Current 0.25mA Max.
- ◆ Over Voltage Protection
- ◆ No Load Power Consumption < 75mW
- ◆ Approved IEC62368-1, EN62368-1, EN62368-1
- ◆ Meets CoC V5 Tier 2 & DoE Level VI  
(Output cable length  $\leq$  1800mm)  
(TRG36A09: Output Cable Length  $\leq$  1220mm)  
(TRG36A05: Output Cable Length  $\leq$  720mm 18AWG/UL2464)



### Ordering information

TRG36AXX- Model No.	XX DC Plug Type	E OVP	XX DC Cable Length and Type
			01: 720mm
			02: 1220mm
			03: 1800mm
			11: 720mm with Ferrite Core
			12: 1220mm with Ferrite Core
			13: 1800mm with Ferrite Core
			*18AWG/UL1185



### Mechanical Dimensions

All Dimensions in Inches (mm)  
Tolerance Inches: X.XXX $\pm$ 0.02  
Millimeters: X.XX $\pm$ 0.5

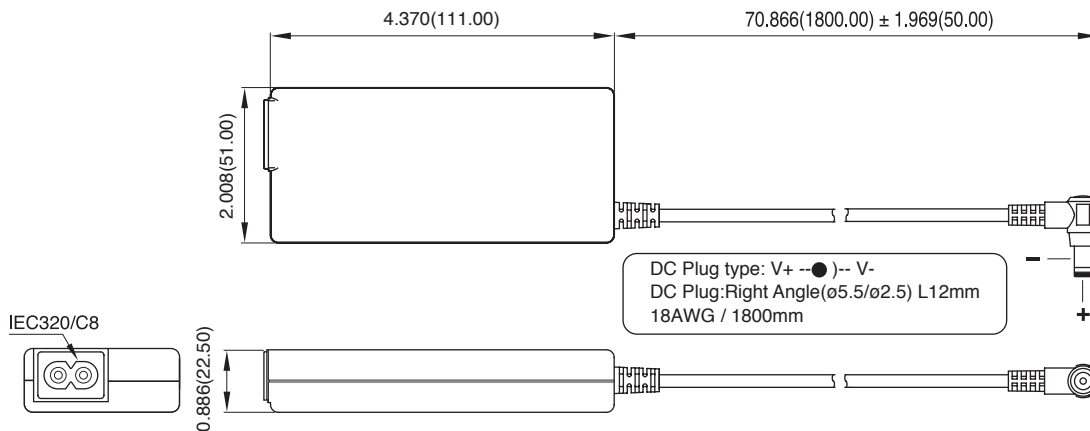

MODEL NUMBER	OUTPUT VOLTAGE	OUTPUT CURRENT	RIPPLE & NOISE (NOTE 1)	VOLTAGE ACCURACY (NOTE 2)	LINE REGULATION (NOTE 3)	LOAD REGULATION (NOTE 4)	AVERAGE EFFICIENCY MIN. (NOTE 5)
TRG36A05	5 V	4.0 A	1%	$\pm$ 2%	$\pm$ 1%	$\pm$ 6%	83.69%
TRG36A09	9 V	3.0 A	1%	$\pm$ 2%	$\pm$ 1%	$\pm$ 5%	87.30%
TRG36A12	12 V	2.5 A	1%	$\pm$ 2%	$\pm$ 1%	$\pm$ 5%	87.70%
TRG36A13	13.5 V	2.4 A	1%	$\pm$ 2%	$\pm$ 1%	$\pm$ 5%	87.97%
TRG36A15	15 V	2.4 A	1%	$\pm$ 2%	$\pm$ 1%	$\pm$ 3%	88.31%
TRG36A18	18 V	2.0 A	1%	$\pm$ 2%	$\pm$ 1%	$\pm$ 2%	88.31%
TRG36A24	24 V	1.5 A	1%	$\pm$ 2%	$\pm$ 1%	$\pm$ 2%	88.31%
TRG36A48	48 V	0.75 A	1%	$\pm$ 2%	$\pm$ 1%	$\pm$ 2%	88.31%

## Derating Curve

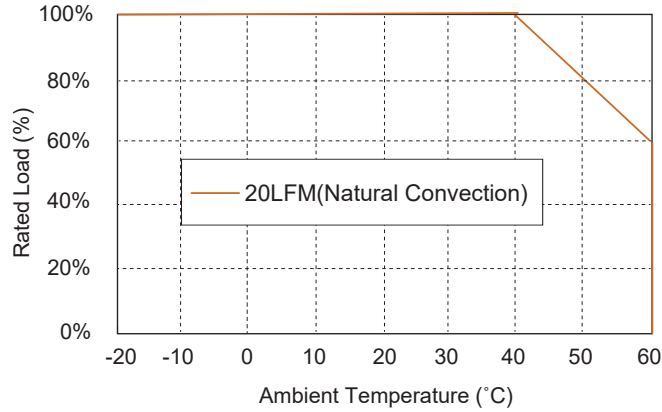

## Specifications

All Specifications Typical At Nominal Line, 75% Load and 25°C Unless Otherwise Noted

### INPUT SPECIFICATIONS

Voltage	90-264Vac
Frequency	50 to 60Hz
Input Current	1A max
Inrush Current	Cold Start@25°C 60A max.@240Vac
Leakage Current	0.25mA max.

### OUTPUT SPECIFICATIONS

Hold-up Time	8ms typ. @115Vac
Short Circuit Protection	Continuous(Auto Recover)
Over Voltage Protection	TVS Component to Clamp
Temperature Coefficient	±0.05%/°C

### SAFETY AND EMISSION

Emission and Immunity	EN55032 Class B, FCC Part 15 Class B, EN61000-6-3, EN61000-3-2, EN61000-3-3 EN55024, EN61204-3, EN61000-6-1
Safety	Class II, IEC62368-1/60950-1, EN62368-1/60950-1, UL62368-1/60950-1

### GENERAL SPECIFICATIONS

Isolation	Input to output= 4,242VDC
Operating Temperature	-20-60°C (see derating curve)
Storage Temperature	-20-85°C
Humidity	93% RH max. Non condensing
Cooling	Natural Convection
Switching Frequency	67KHz typ.
MTBF ... MIL-HDBK-217F, GB, at 25°C/115VAC	200Khrs min.
Altitude	2000m
Dimensions	4.370x2.008x0.886 inches (111.00x51.00x22.50 mm)
Weight	190 g (0.42 Pounds)
AC Inlet	IEC320/C8

### NOTE

1. Add a 0.1µF ceramic capacitor and a 10µF E.L. capacitor to output for ripple & noise measuring @20MHz BW.
2. Voltage setpoint at 60% full load.
3. Line regulation measured from 100VAC to 240VAC full load.
4. Load regulation measured from 60% to full load and from 60% to 20% load (60% +/- 40% load).



# TRH50A SERIES

## 50 WATT, LEVEL VI EFFICIENCY

### Features

- ◆ Universal Input Range 90-264VAC
- ◆ Meets EN55032 Class B and CISPR/FCC Class B
- ◆ Continuous Short Circuit Protection
- ◆ Over Voltage Protection
- ◆ Meets CoC Tier 2 & DoE Level VI  
(Output Cable Length  $\leq$  1800mm)  
(TRH50A120, TRH50A150: Output Cable Length  $\leq$  1220mm)  
(TRH50A180, TRH50A190: Output Cable Length  $\leq$  1800mm 16AWG)
- ◆ No Load Power Consumption < 150mW
- ◆ Approved IEC62368-1, UL62368-1, EN62368-1



### Ordering information

TRH50Axxx	-XX	E	XX
Model No.	DC Plug Type	OVP	DC Cable Length and Type
			01: 720mm
			02: 1220mm
			03: 1800mm
			11: 720mm with Ferrite Core
			12: 1220mm with Ferrite Core
			13: 1800mm with Ferrite Core
			* 16AWG / UL1185 FOR 12V,15V,18V,19V
			* 18AWG / UL1185 FOR 24V,28V,36V,48V



### Mechanical Dimensions

All Dimensions in Inches (mm)  
Tolerance Inches: X.XXX $\pm$ 0.02  
Millimeters: X.XX $\pm$ 0.5

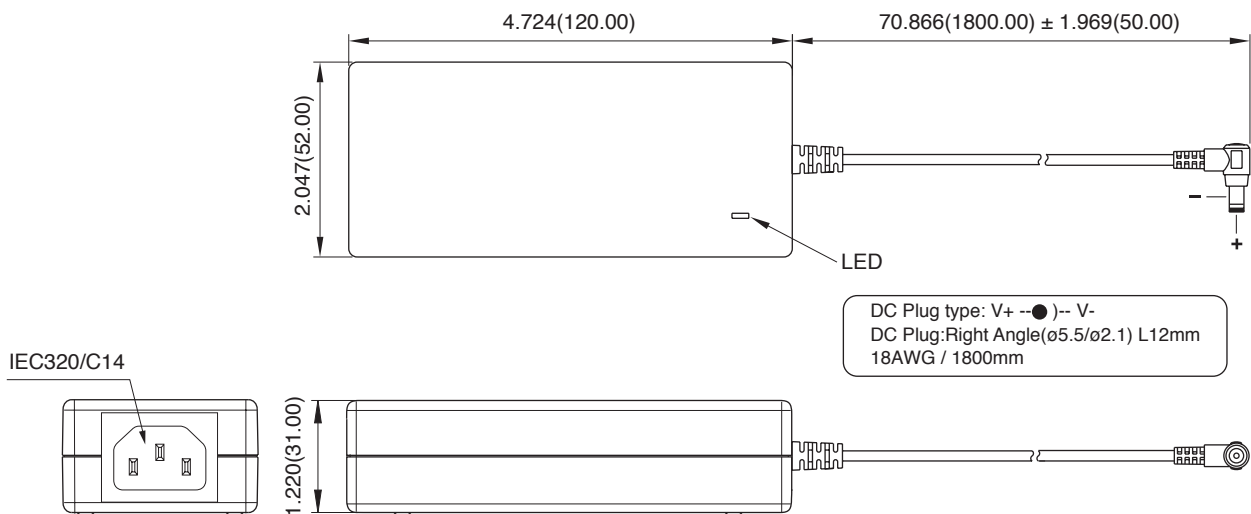

MODEL NUMBER	OUTPUT VOLTAGE	OUTPUT CURRENT	RIPPLE & NOISE (NOTE 1)	VOLTAGE ACCURACY (NOTE 2)	LINE REGULATION (NOTE 3)	LOAD REGULATION (NOTE 4)	AVERAGE EFFICIENCY MIN. (NOTE 5)
TRH50A120	12 V	4.2 A	1%	$\pm$ 2%	$\pm$ 1%	$\pm$ 3%	89%
TRH50A150	15 V	3.36 A	1%	$\pm$ 2%	$\pm$ 1%	$\pm$ 3%	89%
TRH50A180	18 V	2.8 A	1%	$\pm$ 2%	$\pm$ 1%	$\pm$ 2%	89%
TRH50A190	19 V	2.65 A	1%	$\pm$ 2%	$\pm$ 1%	$\pm$ 2%	89%
TRH50A240	24 V	2.1 A	1%	$\pm$ 2%	$\pm$ 1%	$\pm$ 2%	89%
TRH50A280	28 V	1.8 A	1%	$\pm$ 2%	$\pm$ 1%	$\pm$ 2%	89%
TRH50A360	36 V	1.4 A	1%	$\pm$ 2%	$\pm$ 1%	$\pm$ 2%	89%
TRH50A480	48 V	1.05 A	1%	$\pm$ 2%	$\pm$ 1%	$\pm$ 2%	89%

## Derating Curve

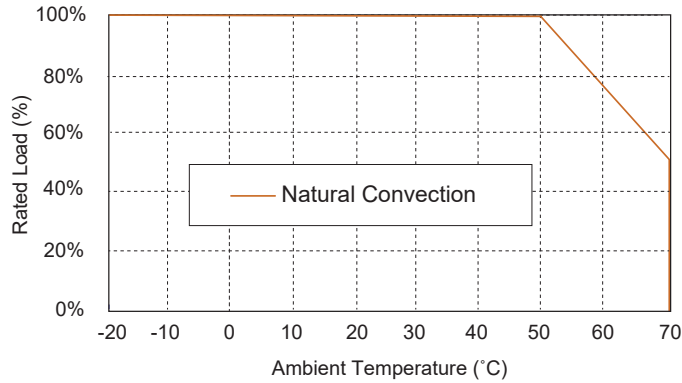

## Specifications

All Specifications Typical At Nominal Line, 75% Load and 25°C Unless Otherwise Noted

### INPUT SPECIFICATIONS

Voltage	90-264Vac
Frequency	47 to 63Hz
Input Current	1.2A max.
Inrush Current	Cold Start@25°C 100A max.@240Vac
Leakage Current	3.5mA max.

### OUTPUT SPECIFICATIONS

Hold-up Time	8ms typ. @115Vac
Short Circuit Protection	Continuous (Auto Recover)
Over Voltage Protection	TVS Component to Clamp
Temperature Coefficient	±0.05%/°C

### SAFETY AND EMISSION

Emission and Immunity	EN55032 Class B, FCC Part 15 Class B, EN61000-6-3, EN61000-3-2, EN61000-3-3, EN55024, EN61204-3, EN61000-6-1
Safety	Class I, IEC62368-1/60950-1, UL62368-1/60950-1, EN62368-1/60950-1

### GENERAL SPECIFICATIONS

Isolation	Input to output = 3,000VDC
Operating Temperature	-20-70°C (see derating curve)
Storage Temperature	-20-85°C
Humidity	93% RH max. Non condensing
Cooling	Natural Convection
Switching Frequency	65KHz typ.
MTBF ... MIL-HDBK-217F, GB, at 25°C/115VAC	200Khrs min.
Altitude	5000m
Dimensions	4.724 x 2.047 x 1.220 inches (120.00 x 52.00 x 31.00 mm)
Weight	300 g
AC Inlet	IEC320/C14

### NOTE

1. Add a 0.1µF ceramic capacitor and a 10µF E.L. capacitor to output for ripple & noise measuring @20MHz BW.
2. Voltage setpoint at 60% full load.
3. Line regulation measured from 100VAC to 240VAC full load.
4. Load regulation measured from 60% to full load and from 60% to 20% load (60% +/- 40% load).
5. Average efficiency measured at 25%, 50%, 75%, 100% load and input voltage is 115Vac / 230Vac.

# TRH70A SERIES

## 70 WATT, LEVEL VI EFFICIENCY

### Features

- ◆ Universal Input Range 90-264VAC
- ◆ Meets EN55032 Class B and CISPR/FCC Class B
- ◆ Continuous Short Circuit Protection
- ◆ Over Voltage Protection
- ◆ Meets CoC Tier 2 & DoE Level VI  
(Output Cable Length  $\leq$  1800mm)  
(TRH70A120: Output Cable Length  $\leq$  720mm)  
(TRH70A150: Output Cable Length  $\leq$  1220mm)  
(TRH70A180, TRH70A190: Output Cable Length  $\leq$  1800mm 16AWG)
- ◆ No Load Power Consumption < 150mW
- ◆ Approved IEC62368-1, UL62368-1, EN62368-1



### Ordering information

TRH70AXXX	-XX	E	XX
Model No.	DC Plug Type	OVP	DC Cable Length and Type
			01: 720mm
			02: 1220mm
			03: 1800mm
			11: 720mm with Ferrite Core
			12: 1220mm with Ferrite Core
			13: 1800mm with Ferrite Core
			* 16AWG / UL1185 FOR 12V,15V,18V,19V
			* 18AWG / UL1185 FOR 24V,28V,36V,48V



### Mechanical Dimensions

All Dimensions in Inches (mm)  
Tolerance Inches: X.XXX $\pm$ 0.02  
Millimeters: X.XX $\pm$ 0.5

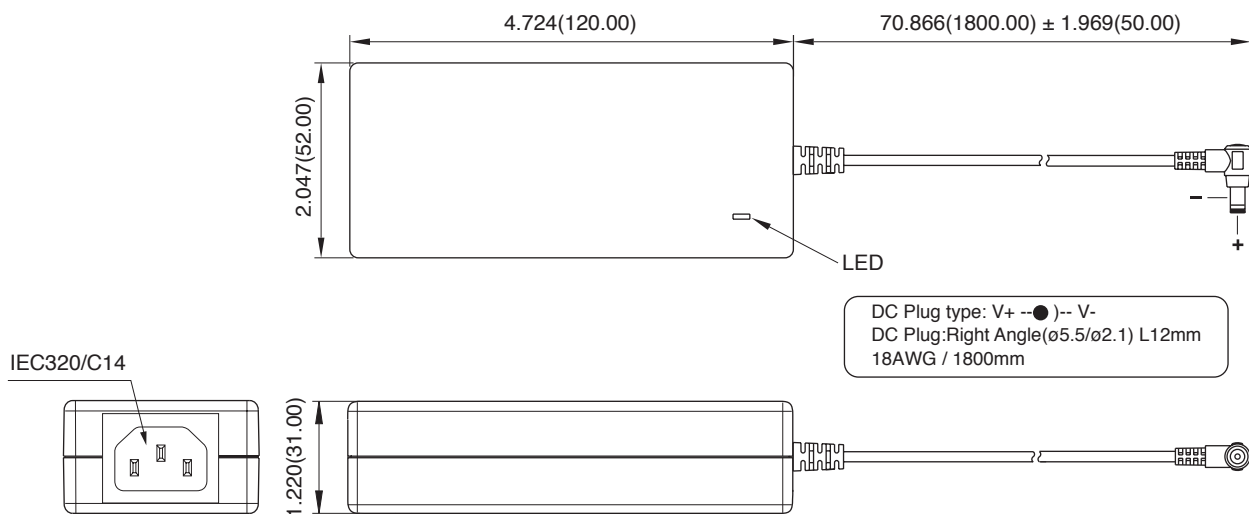

MODEL NUMBER	OUTPUT VOLTAGE	OUTPUT CURRENT	RIPPLE & NOISE (NOTE 1)	VOLTAGE ACCURACY (NOTE 2)	LINE REGULATION (NOTE 3)	LOAD REGULATION (NOTE 4)	AVERAGE EFFICIENCY MIN. (NOTE 5)
TRH70A120	12 V	5.80 A	1%	$\pm$ 2%	$\pm$ 1%	$\pm$ 4%	89%
TRH70A150	15 V	4.65 A	1%	$\pm$ 2%	$\pm$ 1%	$\pm$ 3%	89%
TRH70A180	18 V	3.90 A	1%	$\pm$ 2%	$\pm$ 1%	$\pm$ 2%	89%
TRH70A190	19 V	3.70 A	1%	$\pm$ 2%	$\pm$ 1%	$\pm$ 2%	89%
TRH70A240	24 V	3.00 A	1%	$\pm$ 2%	$\pm$ 1%	$\pm$ 2%	89%
TRH70A280	28 V	2.50 A	1%	$\pm$ 2%	$\pm$ 1%	$\pm$ 2%	89%
TRH70A360	36 V	2.00 A	1%	$\pm$ 2%	$\pm$ 1%	$\pm$ 2%	89%
TRH70A480	48 V	1.50 A	1%	$\pm$ 2%	$\pm$ 1%	$\pm$ 2%	89%

## Derating Curve

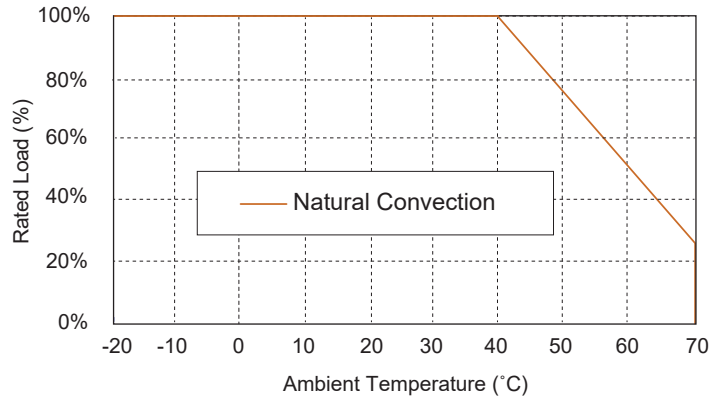

## Specifications

All Specifications Typical At Nominal Line, 75% Load and 25°C Unless Otherwise Noted

### INPUT SPECIFICATIONS

Voltage	90-264Vac
Frequency	47 to 63Hz
Input Current	1.5A max.
Inrush Current	Cold Start@25°C 100A max.@240Vac
Leakage Current	3.5mA max.

### OUTPUT SPECIFICATIONS

Hold-up Time	8ms typ. @115Vac
Short Circuit Protection	Continuous(Auto Recover)
Over Voltage Protection	TVS Component to Clamp
Temperature Coefficient	±0.05%/°C

### SAFETY AND EMISSION

Emission and Immunity	EN55032 Class B, FCC Part 15 Class B, EN61000-6-3, EN61000-3-2,EN61000-3-3 EN55024, EN61204-3, EN61000-6-1
Safety	Class I, IEC62368-1/60950-1, UL62368-1/60950-1 EN62368-1/60950-1

### GENERAL SPECIFICATIONS

Isolation	Input to output= 3,000VDC
Operating Temperature	-20-70°C (see derating curve)
Storage Temperature	-20-85°C
Humidity	93% RH max. Non condensing
Cooling	Natural Convection
Switching Frequency	65KHz Typical
MTBF ... MIL-HDBK-217F, GB, at 25°C/115VAC	200Khrs min.
Altitude	5000m
Dimensions	4.724 x 2.047 x 1.220 inches (120.00 x 52.00 x 31.00 mm)
Weight	300 g
AC Inlet	IEC320/C14

### NOTE

1. Add a 0.1µF ceramic capacitor and a 10µF E.L. capacitor to output for ripple & noise measuring @20MHz BW.
2. Voltage setpoint at 60% full load.
3. Line regulation measured from 100VAC to 240VAC full load.
4. Load regulation measured from 60% to full load and from 60% to 20% load (60% +/- 40% load).
5. Average Efficiency measured at 25%, 50%, 75%, 100% load and input voltage is 115Vac / 230Vac.

# TRG70E VI SERIES

## 70W SWITCHING ADAPTER

### Features

- ◆ Universal Input Range 90 -264VAC
- ◆ Meets EN55032 Class B and CISPR/FCC Class B
- ◆ Continuous Short Circuit Protection
- ◆ Over Voltage Protection
- ◆ No Load Power Consumption<150mW
- ◆ Meet CoC Tier 2 & DoE Level VI  
(TRG70E120:Output Cable Length $\leq$ 720mm 16AWG)  
(TRG70E240: Output Cable Length $\leq$ 1800mm 18AWG)



### Ordering information

TRG70EXXX- XX	X	XX
Model No.	DC Plug Type	DC Cable Length and Type
	OVP	
	E: With OVP	01: 720mm
		02: 1220mm
		03: 1800mm
		11: 720mm with Ferrite Core
		12:1220mm with Ferrite Core
		13:1800mm with Ferrite Core
		*18AWG/UL1185



### Mechanical Dimensions

All Dimensions are in inches(mm)  
Tolerance:Inches:X.XXX $\pm$ 0.02  
Millimeters:X.XX $\pm$ 0.5

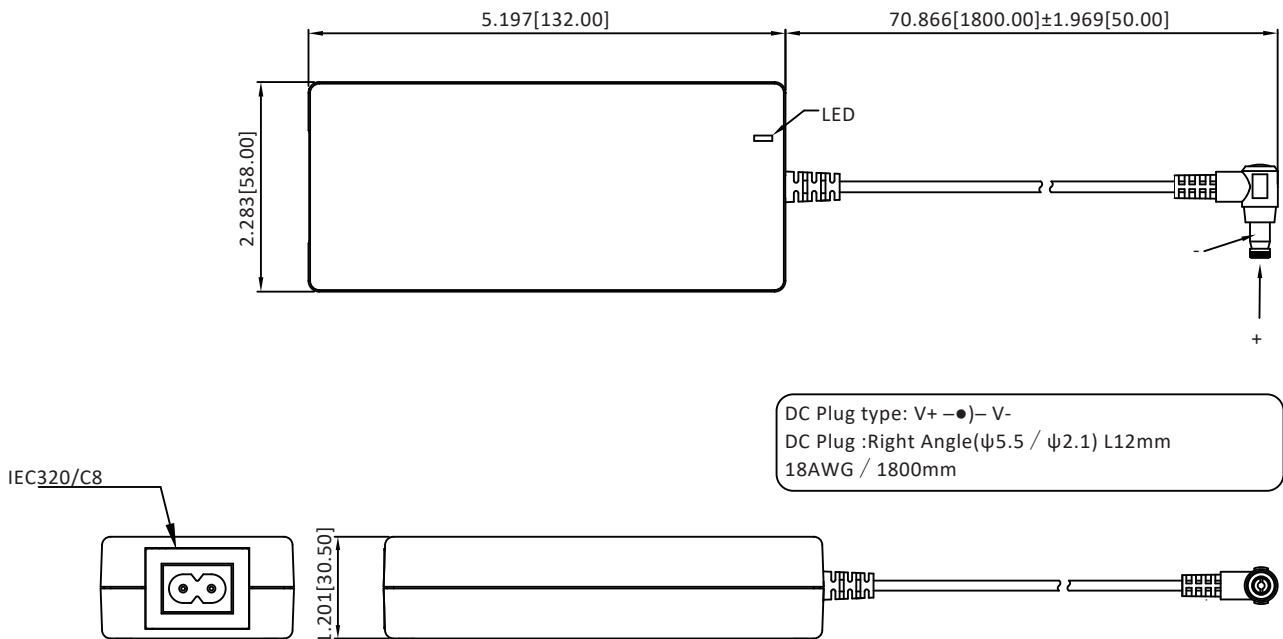

MODEL	OUTPUT VOLTAGE	OUTPUT CURRENT	RIPPLE (mVp-p) (NOTE 2)	VOLTAGE ACCURACY (NOTE 1)	LINE REGULATION (NOTE 3)	LOAD REGULATION (NOTE 4)	EFFICIENCY (typ.) (NOTE 5)
TRG70E120	12 V	5.5 A	1%	$\pm$ 2%	$\pm$ 1%	$\pm$ 5%	89%
TRG70E240	24 V	3.0 A	1%	$\pm$ 2%	$\pm$ 1%	$\pm$ 2%	89%

## Derating Curve

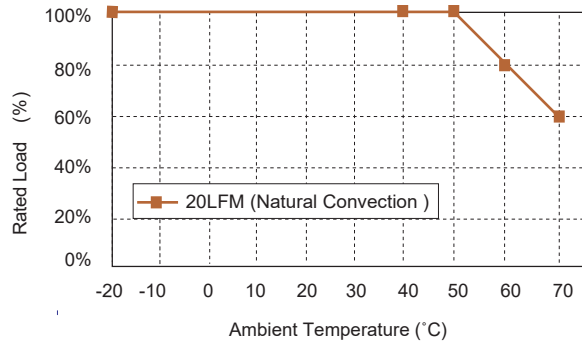

## Specifications

All Specifications Typical At Nominal Line, Full Load, and 25°C Unless Otherwise Noted

### INPUT SPECIFICATIONS

Voltage	90-264Vac 120-370Vdc
Frequency	47 to 63Hz
Input Current	Cold Start @25°C 80A max. @240Vac
Conducted EMI	CISPR/FCC Class B
Leakage Current	0.25mA max.

### OUTPUT SPECIFICATIONS

Hold-up Time	8ms typ. @115Vac
Short Circuit Protection	Hiccup Mode (Auto Recovery)
Over Voltage Protection	TVS Component to Clamp
Temperature Coefficient	±0.05%/°C

### SAFETY AND EMISSION

Emission and Immunity	EN55032 Class B, FCC Part 15 Class B EN61000-6-3, EN61000-3-2, EN61000-3-3 EN55024, EN61204-3, EN61000-6-1
Safety	Class II, IEC60950-1, EN60950-1, UL60950-1

### GENERAL SPECIFICATIONS

Isolation	Input to output = 3000VAC
Operating Temperature	-20 -70°C (see derating curve)
Storage Temperature	-20 -85°C
Humidity	93% RH max. Non condensing
Cooling	Natural Convection
Switching Frequency	60KHz Typical
MTBF	
MIL-HDBK-217F, GB, at 25°C/115VAC	200Khrs min.
Altitude	2000m
Dimensions	5.197x2.283x1.201 inches (132.00x58.00x30.50 mm)
Weight	345g(0.76 Pounds)
AC Inlet	IEC320/C8

### NOTE

1. Voltage accuracy at 60% full load
2. Add a 0.1uF ceramic capacitor and a 10uF E.L. capacitor to output for ripple&noise measurement @20MHz BW.
3. Line regulation is measured from 100Vac to 240Vac, full load.
4. Load regulation is measured from 60% to 100% full load and from 60% to 20% full load (60% +/- 40% full load).
5. Typical efficiency at 230VAC and 75% load at 25°C.

# TRH100A SERIES

## 100 WATT, LEVEL VI EFFICIENCY

### Features

- ◆ Universal Input Range: 90-264VAC
- ◆ Active PFC Meets EN61000-3-2
- ◆ Conductive EMI Meets CISPR/FCC Class B
- ◆ No Load power consumption < 150mW
- ◆ Continuous Short Circuit Protection
- ◆ Over Voltage Protection
- ◆ Meets CoC Tier 2 & DoE Level VI  
(Output Cable Length  $\leq$  1800mm)  
(TRH100A120-150: Output Cable Length  $\leq$  1220mm)  
(TRH100A180-480: Output Cable Length  $\leq$  1800mm)



### Ordering information

TRH100Axxx- Model No.	XX DC Plug Type	X OVP E: WITH OVP	XX DC Cable Length and Type 11: 720mm with Ferrite Core 12: 1220mm with Ferrite Core* 13: 1800mm with Ferrite Core 14: 1000mm with Ferrite Core 21: 720mm with two Ferrite Core 22: 1220mm with two Ferrite Core 23: 1800mm with two Ferrite Core *UL2464 For all models
--------------------------	--------------------	-------------------------	---



### Mechanical Dimensions

All Dimensions in Inches (mm)  
Tolerance Inches: X.XXX $\pm$ 0.02  
Millimeters: X.XX $\pm$ 0.5

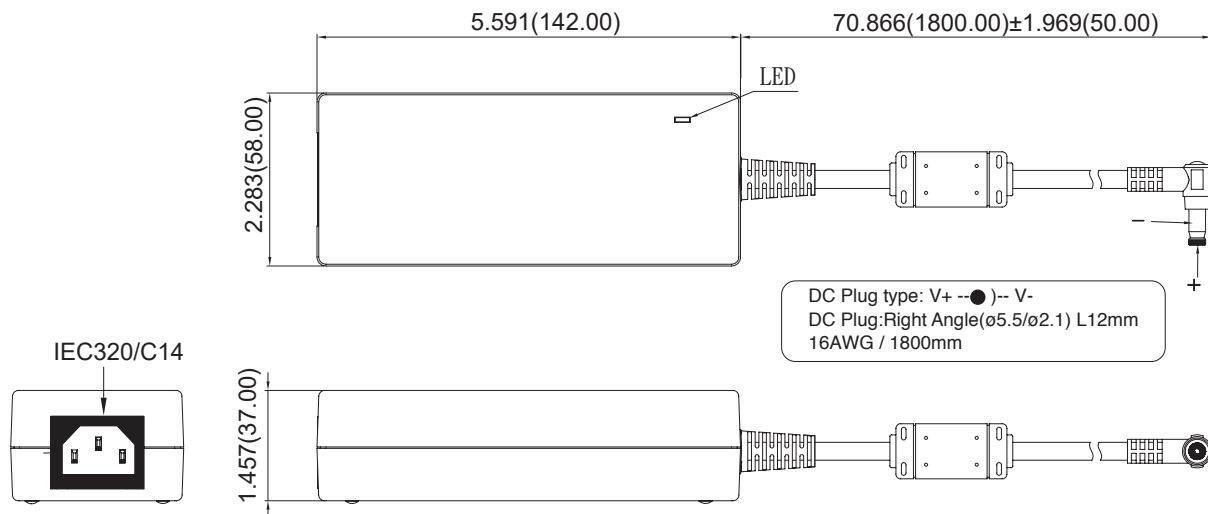

MODEL NUMBER	OUTPUT VOLTAGE	MIN. LOAD	OUTPUT CURRENT	RIPPLE & NOISE (NOTE 1)	VOLTAGE SETPOINT (NOTE 2)	LINE REGULATION (NOTE 3)	LOAD REGULATION (NOTE 4)	% EFF. (Typ.) (NOTE 5)
TRH100A120	12 V	0 A	8.34 A	1%	$\pm$ 2%	$\pm$ 1%	$\pm$ 4%	89%
TRH100A135	13.5 V	0 A	7.33 A	1%	$\pm$ 2%	$\pm$ 1%	$\pm$ 4%	89%
TRH100A150	15 V	0 A	6.67 A	1%	$\pm$ 2%	$\pm$ 1%	$\pm$ 4%	89%
TRH100A180	18 V	0 A	5.56 A	1%	$\pm$ 2%	$\pm$ 1%	$\pm$ 2%	89%
TRH100A190	19 V	0 A	5.26 A	1%	$\pm$ 2%	$\pm$ 1%	$\pm$ 2%	89%
TRH100A240	24 V	0 A	4.17 A	1%	$\pm$ 2%	$\pm$ 1%	$\pm$ 2%	89%
TRH100A280	28 V	0 A	3.54 A	1%	$\pm$ 2%	$\pm$ 1%	$\pm$ 2%	89%
TRH100A360	36 V	0 A	2.78 A	1%	$\pm$ 2%	$\pm$ 1%	$\pm$ 2%	89%
TRH100A480	48 V	0 A	2.1 A	1%	$\pm$ 2%	$\pm$ 1%	$\pm$ 2%	89%

## Derating Curve

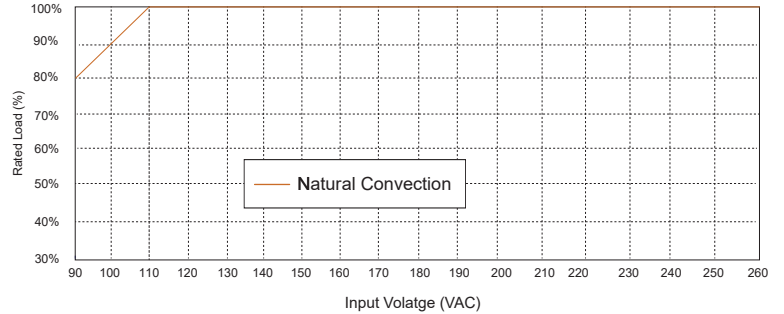
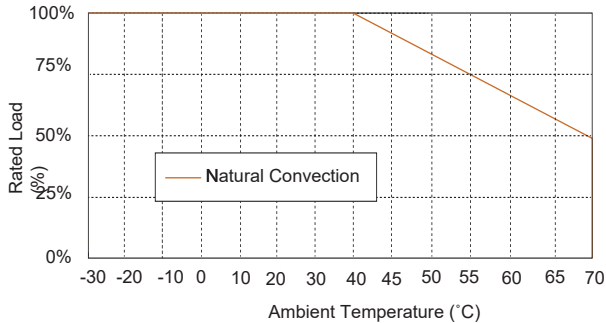

## Specifications

All Specifications Typical At Nominal Line, 75% Load and 25°C Unless Otherwise Noted

### INPUT SPECIFICATIONS

Voltage	90-264Vac
Frequency	47 to 63Hz
Inrush Current	120A max. @240Vac
Conducted EMI	CISPR/FCC Class B
Leakage Current	3.5mA max.

### OUTPUT SPECIFICATIONS

Hold-up Time	16ms typ. @115Vac
Short Circuit Protection	Continuous
Over Voltage Protection	Yes

### SAFETY AND EMISSION

Emission and Immunity	EN55032 Class B, FCC Part 15 Class B, EN61000-3-2 EN61000-3-3, EN55024 EN61204-3
Safety	Class I, IEC62368-1/60950-1, UL62368-1/60950-1 EN62368-1/60950-1

### GENERAL SPECIFICATIONS

Isolation	Input to output = 4,242VDC
Operating Temperature	-30° C-70° C, 40° C-70° C with 1.67%/° C Derating
Storage Temperature	-40-85 ° C
Operating Humidity	93%RH max. no condensing
Cooling	Natural Convection
Switching Frequency	65KHz Typical
Operating Altitude	Sea Level to 5000m IEC320/ C14,C6
AC Inlet	5.591 x 2.283 x 1.457 inches (142.00 x 58.00 x 37.00 mm)
Dimensions	485 g
Weight	

### NOTE

1. Add a 0.1µF ceramic capacitor and a 10µF E.L. capacitor to output for ripple & noise measuring @20MHz BW.
2. Voltage setpoint at 60% full load.
3. Line regulation measured from 100VAC to 240VAC with full load.
4. Load regulation measured from 60% to full load and from 60% to 20% load (60% +/- 40% full load).
5. Average Efficiency measured at 25%, 50%, 75%, 100% load and input voltage is 115Vac / 230Vac.
6. Inrush current at 120A Max./ 200us for AC turn on.



# TRH150A SERIES

## 150 WATT, LEVEL VI EFFICIENCY

### Features

- ◆ Universal Input Range: 90-264VAC
- ◆ Active PFC Meets EN61000-3-2
- ◆ Conductive EMI Meets CISPR/FCC Class B
- ◆ No Load power consumption < 150mW
- ◆ Continuous Short Circuit Protection
- ◆ Over Voltage Protection
- ◆ Meets CoC Tier 2 & DoE Level VI  
(TRH150A120-150: Output Cable Length  $\leq$  950mm)  
(TRH150A180-480: Output Cable Length  $\leq$  1220mm)



### Ordering information

TRH150Axxx- Model No.	XX DC Plug Type	X OVP E: WITH OVP	XX DC Cable Length and Type 471:950mm with Ferrite Core 12: 1200mm with Ferrite Core *UL2464 For all models
--------------------------	--------------------	-------------------------	---

Please see catalogue page 71, only KPPX-4P for 12V model and 15V model

KPPX-4P DC Plug Type for 12V model and 15V model:

1424	KPPX-4P, 4Pin Power Plug Assembly Type with Lock Mechanism Pin1,2:+ · Pin3,4,shell:-"
1442	KPPX-4P, 4Pin Power Plug Assembly Type with Lock Mechanism ,Pin1,3:"+",Pin2,4,Shell:-"
1446	KPPX-4P, 4Pin Power Plug Assembly Type with Lock Mechanism, Pin1,3:"-",Pin2,4:"+"
1538	KPPX-4P, 4Pin Power Plug Molded Type without Lock Mechanism Pin1,2:+ · Pin3,4:-



### Mechanical Dimensions

All Dimensions in Inches (mm)  
Tolerance Inches: X.XXX $\pm$ 0.02  
Millimeters: X.XX $\pm$ 0.5

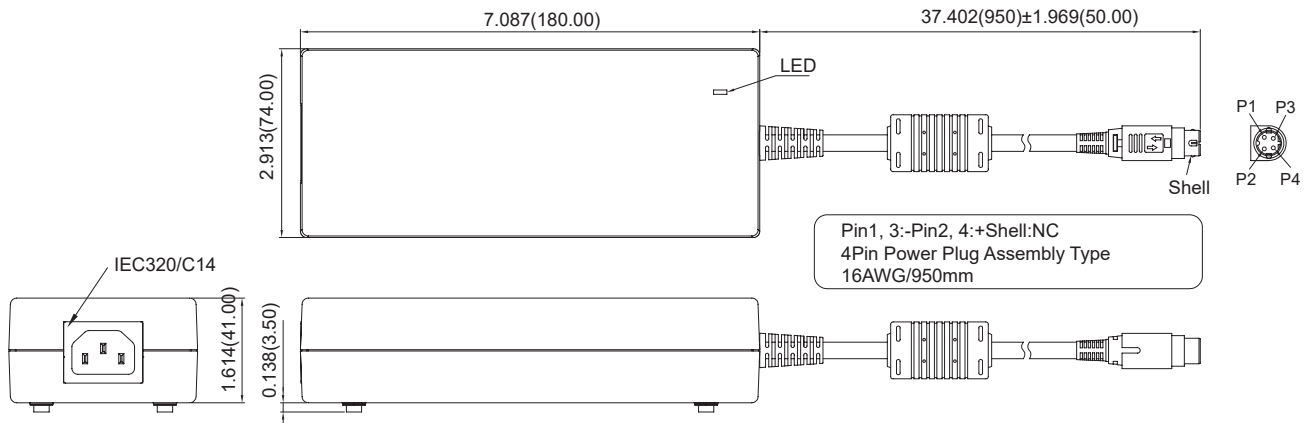

MODEL NUMBER	OUTPUT VOLTAGE	MIN. LOAD	OUTPUT CURRENT	RIPPLE & NOISE (NOTE 1)	VOLTAGE SETPOINT (NOTE 2)	LINE REGULATION (NOTE 3)	LOAD REGULATION (NOTE 4)	% EFF. (Typ.) (NOTE 5)
TRH150A120	12 V	0 A	12.50 A	2%	$\pm$ 2.5%	$\pm$ 1%	$\pm$ 5%	91%
TRH150A150	15 V	0 A	10.00 A	2%	$\pm$ 2.5%	$\pm$ 1%	$\pm$ 5%	92%
TRH150A180	18 V	0 A	8.34 A	2%	$\pm$ 2.5%	$\pm$ 1%	$\pm$ 5%	92%
TRH150A190	19 V	0 A	7.90 A	2%	$\pm$ 2.5%	$\pm$ 1%	$\pm$ 5%	92%
TRH150A240	24 V	0 A	6.25 A	2%	$\pm$ 2.5%	$\pm$ 1%	$\pm$ 5%	93%
TRH150A280	28 V	0 A	5.36 A	2%	$\pm$ 2.5%	$\pm$ 1%	$\pm$ 5%	94%
TRH150A360	36 V	0 A	4.17 A	2%	$\pm$ 2.5%	$\pm$ 1%	$\pm$ 5%	93%
TRH150A480	48 V	0 A	3.13 A	2%	$\pm$ 2.5%	$\pm$ 1%	$\pm$ 5%	94%

## Derating Curve

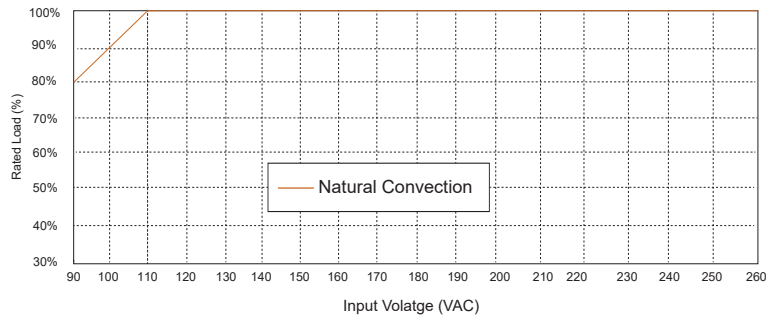
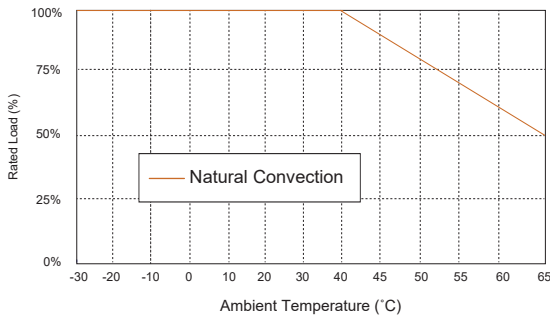

## Specifications

All Specifications Typical At Nominal Line, 75% Load and 25°C Unless Otherwise Noted

### INPUT SPECIFICATIONS

Voltage	90-264Vac
Frequency	47 to 63Hz
Inrush Current	120A max. @240Vac(NOTE6)
Conducted EMI	CISPR/FCC Class B
Leakage Current	3.5mA max.

### OUTPUT SPECIFICATIONS

Hold-up Time	16ms typ. @115Vac
Short Circuit Protection	Continuous
Over Voltage Protection	Yes

### SAFETY AND EMISSION

Emission and Immunity	EN55032 Class B, FCC Part 15 Class B, EN61000-3-2 EN61000-3-3, EN55024 EN61204-3
Safety	Class I, IEC60950-1, EN60950-1, UL60950-1

### GENERAL SPECIFICATIONS

Isolation	Input to output = 4,242VDC
Operating Temperature	-30°C-65°C, 40°C-65°C with 2%/°C Derating
Storage Temperature	-40-85°C
Operating Humidity	93%RH max. no condensing
Cooling	Natural Convection
Switching Frequency	100KHz Typical
AC Inlet	IEC320/C14
Dimensions	7.087 x 2.913 x 1.614 inches (180.00 x 74.00 x 41.00 mm)
Weight	950 g

### NOTE

1. Add a 0.1μF ceramic capacitor and a 10μF E.L. capacitor to output for ripple & noise measuring @20MHz BW.
2. Voltage setpoint at 60% full load.
3. Line regulation measured from 100VAC to 240VAC with full load.
4. Load regulation measured from 60% to full load and from 60% to 20% load (60% +/- 40% full load).
5. Average Efficiency measured at 25%, 50%, 75%, 100% load and input voltage is 115Vac / 230Vac.
6. Inrush current at 120A Max./ 200us for AC turn on.

# AC POWER CORD

**C13+US Plug**  
**P/N: G7472205014**  
**LT-202+501**

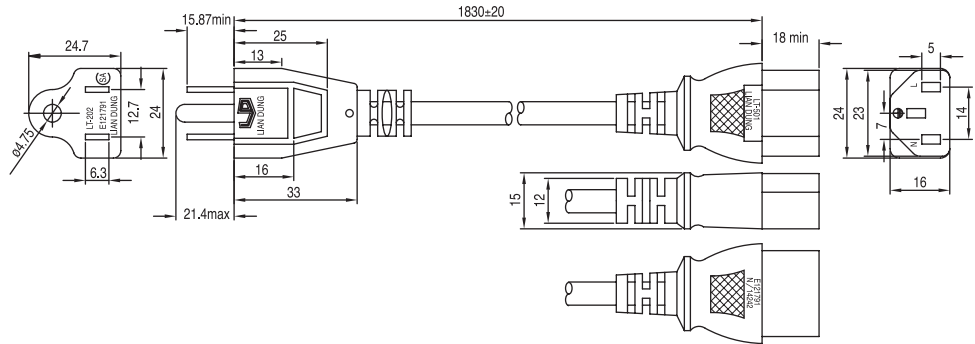

**C13+European Plug**  
**P/N: G7472205414**  
**LT-322+501**

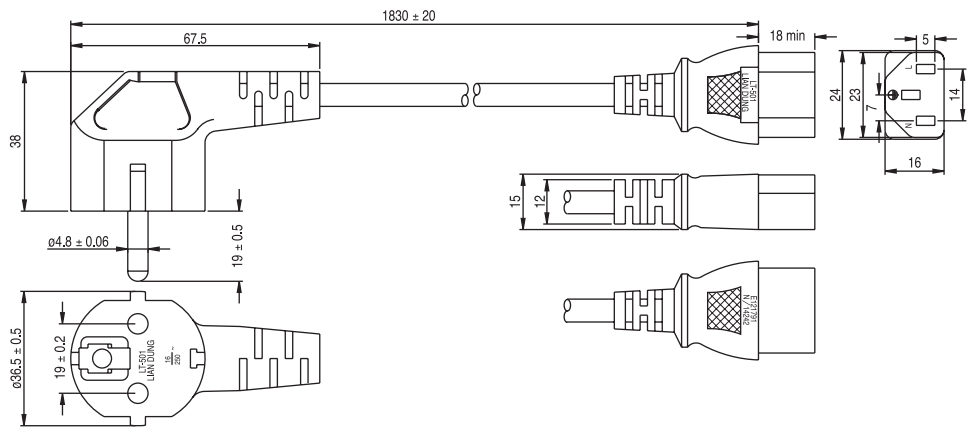

**C13+UK Plug**  
**P/N: G7472206214**  
**LT-318+501A**

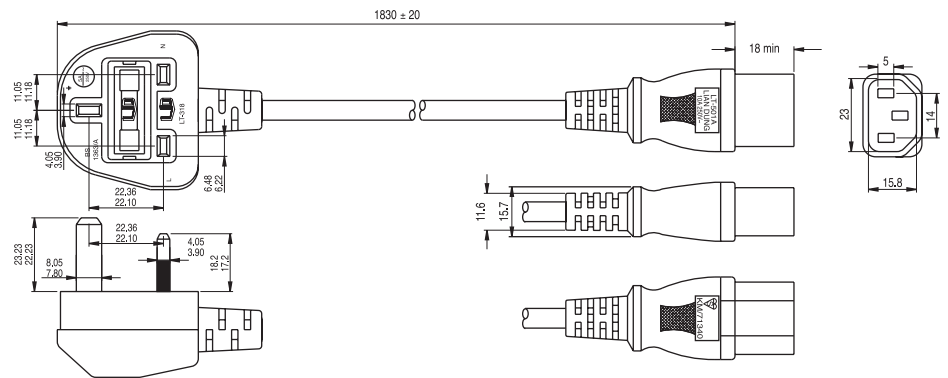

**C13+Australian Plug**  
**P/N: G7472205514**  
**LT-208+501**

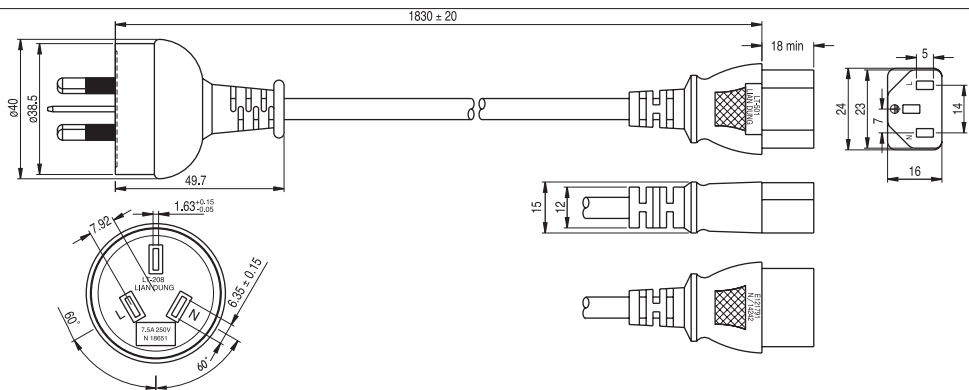

**C7+US Plug**  
P/N: G7476205014  
LT-301+503

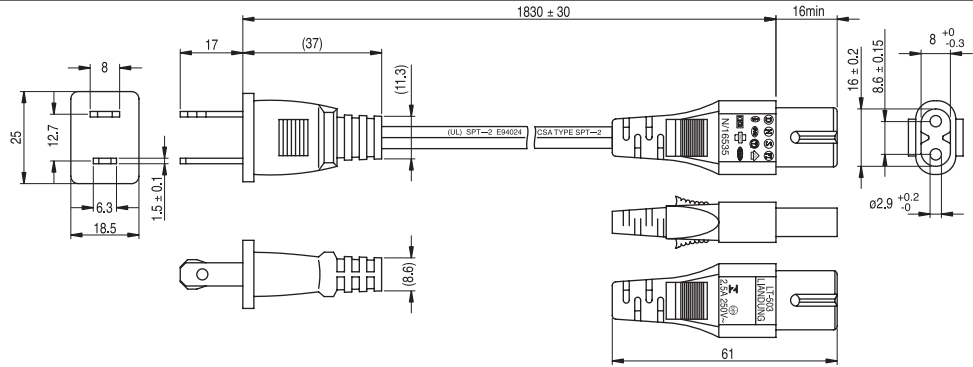

**C7+European Plug**  
P/N: G7472205314  
LT-207+503

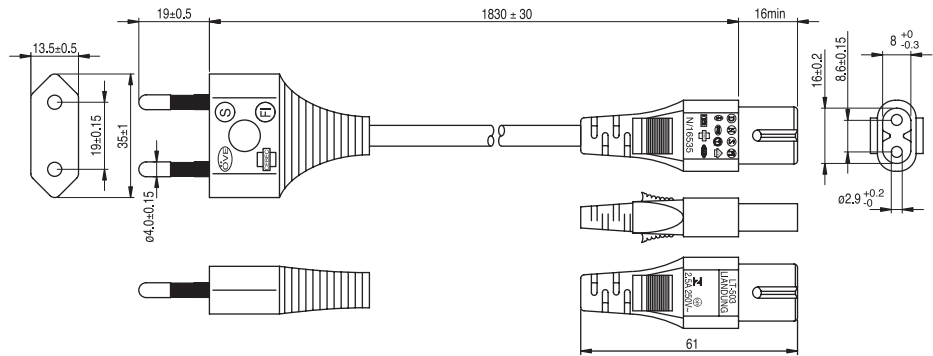

**C7+UK Plug**  
P/N: G7472205214  
LT-317+503

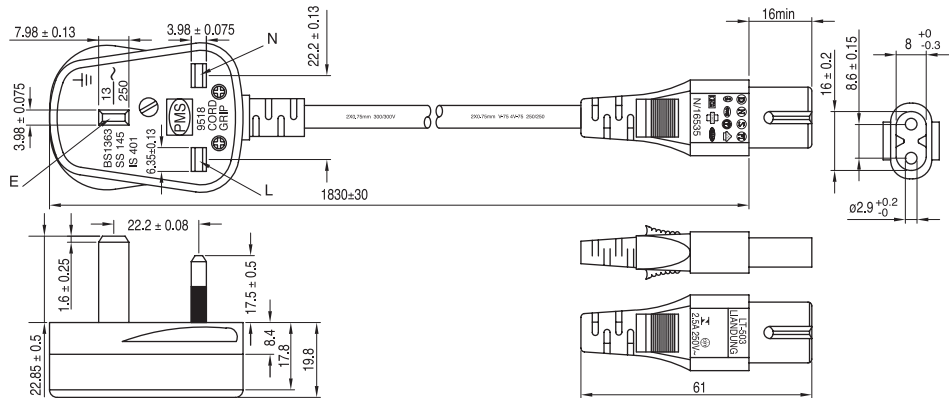

**C7+Australian Plug**  
P/N: G7472207014  
LT-219+503

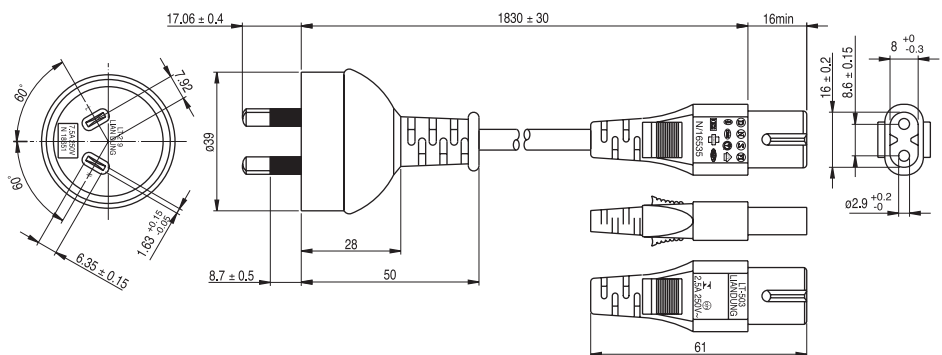

# SWITCHING ADAPTER PART NUMBER CONFIGURATION

## WALL-MOUNT AC-DC SWITCHING ADAPTER

TRXXX -		XX		X	XX
Model No.	AC Plug Type	DC Plug Type		OVP Option	DC Cable Length and Type
A : USA 2 Pin		<b>Straight/Inner+Outer-</b>	<b>Right Angle/Inner+Outer-</b>	A: Without OVP Option	01: 720mm
E : Europe 2 Pin		<b>+ — ● ) — -</b>	<b>+ — ● ) — -</b>	E : With OVP Option	02: 1220mm
U : British 3 Pin		11 : 5.5 x 2.1 x 12mm	01 : 5.5 x 2.1 x 12mm		03: 1800mm
S : Australia 2 Pin		12 : 5.5 x 2.5 x 12mm	02 : 5.5 x 2.5 x 12mm		11: 720mm with Ferrite Core
		18 : 5.5 x 2.5 x 11mm	17 : 5.5 x 2.1 x 11mm		12: 1220mm with Ferrite Core
		23 : 5.5 x 2.1 x 9.5mm	19 : 5.5 x 2.5 x 10.5mm		13: 1800mm with Ferrite Core
		26 : 5.5 x 2.5 x 9.5mm	20 : 5.5 x 2.5 x 9mm		
		32 : 5.5 x 2.1 x 7.5mm	21 : 5.5 x 2.5 x 9.5mm		
		33 : 5.5 x 2.1 x 11.5mm	24 : 5.5 x 2.1 x 9.5mm		
		35 : 4.0 x 1.7 x 9.5mm	31 : 3.5 x 1.35 x 7.5mm		
		37 : 5.5 x 2.5 x 7.5mm	34 : 5.5 x 2.1 x 11.5mm		
		39 : 3.5 x 1.35 x 9mm	36 : 3.5 x 1.35 x 9mm		
		41 : 3.5 x 1.35 x 7.5mm	40 : 4.0 x 1.7 x 9.5mm		
		45 : 4.75 x 1.7 x 9.5mm	42 : 3.5 x 1.35 x 9.5mm		
		50 : 4.0 x 1.7 x 11mm	46 : 4.0 x 1.7 x 12mm		
			48 : 5 x 1.5 x 9.5mm		
			49 : 2.35 x 0.7 x 9.5mm		
		<b>Straight/Inner-Outer+</b>	<b>Right Angle / Inner-Outer+</b>		
		<b>- — ● ) — +</b>	<b>- — ● ) — +</b>		
		05 : 5.5 x 2.1 x 12mm	03 : 5.5 x 2.1 x 12mm		
		13 : 5.5 x 2.1 x 12mm	04 : 5.5 x 2.5 x 12mm		
		14 : 5.5 x 2.5 x 12mm	16 : 5.5 x 2.1 x 11mm		
		27 : 5.5 x 2.5 x 9.5mm	22 : 5.5 x 2.5 x 9.5mm		
			43 : 5.5 x 2.1 x 9.5mm		
			44 : 3.5 x 1.35 x 7.5mm		
			105 : 3.5 x 1.05 x 9.5mm		
			111 : 3.5 x 1.35 x 9.5mm		
			122 : 3.5 x 1.35 x 12mm		
			141 : 5.5 x 2.1 x 11mm		
			150 : 3.5 x 1.35 x 9mm		
			317 : 5.5 x 2.5 x 9mm		





## DESK-TOP AC-DC SWITCHING ADAPTER

TRXXXXX -

XX

X

XX

Model No.	DC Plug Type	OVP Option	DC Cable Length and Type	
	<p><b>Straight/Inner+Outer-</b></p> <p></p> <p>11 : 5.5 x 2.1 x 12mm            12 : 5.5 x 2.5 x 12mm            18 : 5.5 x 2.5 x 11mm            23 : 5.5 x 2.1 x 9.5mm            26 : 5.5 x 2.5 x 9.5mm            32 : 5.5 x 2.1 x 7.5mm            33 : 5.5 x 2.1 x 11.5mm            35 : 4.0 x 1.7 x 9.5mm            37 : 5.5 x 2.5 x 7.5mm            39 : 3.5 x 1.35 x 9mm            41 : 3.5 x 1.35 x 7.5mm            45 : 4.75 x 1.7 x 9.5mm            50 : 4.0 x 1.7 x 11mm</p>	<p><b>Right Angle/Inner+Outer-</b></p> <p></p> <p>01 : 5.5 x 2.1 x 12mm            02 : 5.5 x 2.5 x 12mm            17 : 5.5 x 2.1 x 11mm            19 : 5.5 x 2.5 x 10.5mm            20 : 5.5 x 2.5 x 9mm            21 : 5.5 x 2.5 x 9.5mm            24 : 5.5 x 2.1 x 9.5mm            31 : 3.5 x 1.35 x 7.5mm            34 : 5.5 x 2.1 x 11.5mm            36 : 3.5 x 1.35 x 9mm            40 : 4.0 x 1.7 x 9.5mm            42 : 3.5 x 1.35 x 9.5mm            46 : 4.0 x 1.7 x 12mm            48 : 5 x 1.5 x 9.5mm            49 : 2.35 x 0.7 x 9.5mm</p>	<p>A: Without OVP Option            E : With OVP Option</p>	<p>01: 720mm            02: 1220mm            03: 1800mm            11: 720mm with Ferrite Core            12: 1220mm with Ferrite Core            13: 1800mm with Ferrite Core</p>
	<p><b>Straight/Inner-Outer+</b></p> <p></p> <p>05 : 5.5 x 2.1 x 12mm            13 : 5.5 x 2.1 x 12mm            14 : 5.5 x 2.5 x 12mm            27 : 5.5 x 2.5 x 9.5mm</p>	<p><b>Right Angle/Inner-Outer+</b></p> <p></p> <p>03 : 5.5 x 2.1 x 12mm            04 : 5.5 x 2.5 x 12mm            16 : 5.5 x 2.1 x 11mm            22 : 5.5 x 2.5 x 9.5mm            43 : 5.5 x 2.1 x 9.5mm            44 : 3.5 x 1.35 x 7.5mm</p>		

*Cincon offers a wide variety of DC plugs for every customers.*

*Please contact your distributor or E-Mail [sales@cincon.com.tw](mailto:sales@cincon.com.tw) for more information.*

# Rapid Standard-Modification, Value Added & Customized Power Supplies. Cincon offers a high degree of flexibility in product designs.

Cincon provides a broad range of standard products that address the needs of many applications, there are occasions when a standard product doesn't address all your application requirements.

By years of experience in developing our customers with solutions on demand, do not hesitate to talk to Cincon to obtain your preferred products.

## Cincon Headquarters

14F, No. 306, Section 4, Hsin Yi Rd., Taipei, Taiwan  
Tel: (886-2) 2708-6210  
E-mail: sales@cincon.com.tw

## Cincon USA

1655 Mesa Verde Ave, Ste 180  
Ventura, CA 93003 USA  
Tel: (805) 639-3350  
E-mail: info@cincon.com

## POWER SUPPLY - REQUEST FOR QUOTE - by fax +886 2 2702 9852

Company \_\_\_\_\_ Date \_\_\_\_\_

First Name \_\_\_\_\_ Last Name \_\_\_\_\_

Country \_\_\_\_\_ City \_\_\_\_\_

Address \_\_\_\_\_

Telephone \_\_\_\_\_ Fax \_\_\_\_\_

E-mail \_\_\_\_\_

Product Type

Application

Output Voltages

Output Currents

Input Voltages

Efficiency

Isolation

Protection

Storage / Operating Temperature Range

Safety Standard

EMC Standard

Mechanical Description

Remarks

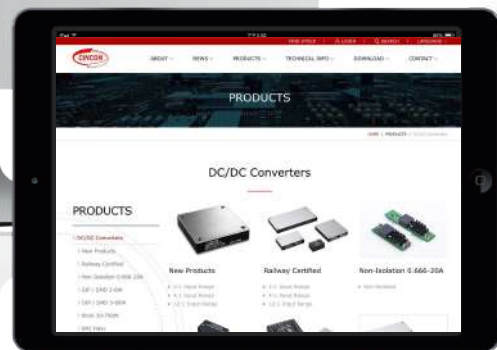
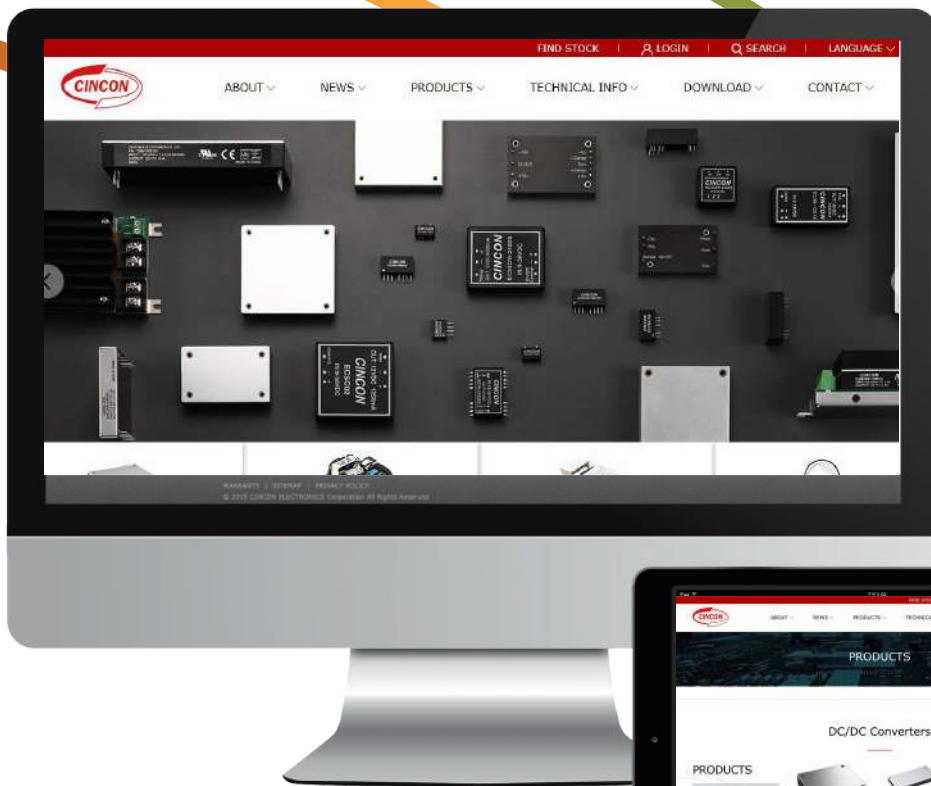

**Visit Our Website**  
**[WWW.CINCON.COM](http://WWW.CINCON.COM)**

### **On Cincon Website**

- ✓ You can download latest datasheets & application notes
- ✓ You can find all new product releases and latest news
- ✓ You can find Cincon sales representative & distributors
- ✓ You can check stock and send product inquiry to us

**Let Cincon Power Your Idea**



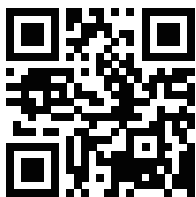

[WWW.CINCON.COM](http://WWW.CINCON.COM)

**CINCON HEADQUARTERS**

14F , No. 306, Section 4, Hsin Yi Road Taipei, Taiwan, R.O.C.

Tel : (886-2) 2708-6210 | Fax : (886-2) 2702-9852

E-mail : [sales@cincon.com.tw](mailto:sales@cincon.com.tw)

**CINCON USA**

1655 Mesa Verde Ave, Ste 180 Ventura , CA 93003 USA

Tel : (805) 639-3350 | Fax : (805) 639-4101

E-mail : [info@cincon.com](mailto:info@cincon.com)