

CINCON ELECTRONICS

MEDICAL POWER SUPPLY CATALOG 2019



Every day, 365 days a year Cincon makes a difference in people's lives throughout the world.

Design engineers and other power supply specifiers select our AC-DC and DC-DC convertors to power a wide range of products. Cincon power supplies are found in a myriad of applications, from medical equipment used to keep us healthy, to security systems working to keep us safe. Name an electronic device in any equipment category and it's likely you'll find a Cincon power supply inside. The communications, test instrumentation, entertainment, lighting, medical, computer, networking, industrial and transportation industries all use Cincon power supplies.

Cincon gives power supply specifiers what they need, speed and specification. Need a power supply fast? Designers can select from one of our 25,000 plus standard model numbers, many available off the shelf from distributors located around the globe. Give us a little more time and we can modify one of our standard products to your requirement. Need a full custom power supply? We do that also.

Using state of the art design tools, our power supplies are engineered with proven technology in one of our two Taiwan design laboratories. We focus heavily on reliability

in the early stages of development to ensure a robust final product. Combined with extensive verification testing at the prototype and pilot production stages, Cincon is able to offer power supplies with long operational lives.

Cincon AC-DC and DC-DC power supplies are manufactured in one of our wholly owned, ISO 9001 and ISO 14001 certified, manufacturing facilities in Taiwan and China. Products are built using the latest manufacturing and quality assurance techniques on state of the art equipment; giving our customers not only high quality but also short lead times.

As a global designer and manufacturer of AC-DC and DC-DC power supplies, our products are certified to international safety, efficiency, hazardous substance and EMI standards where required. We also have capability to design and certify to application and country specific standards.

When you require an AC-DC or DC-DC power supply, standard or custom, and have little time, look to us for a solution. Let Cincon power your idea.

CONTENTS

	CFM21	20W	2
NEW	CFM21M	20W	4
	CFM40M	40W	6
	CFM60M	60W	8
	CFM100M	100W	10
NEW	CFM130M	130W	12
	CFM150M	150W	14
	CFM200M	200W	16
	CFM300M	300W	18
	CFM351M	350W	20
NEW	CFM500M	500W	22
	TR15RAM	15W	24
NEW	TR18RDM	18W	26
NEW	TR30RDM	30W	28
	TR30RAM	30W	30
NEW	TR36M	36W	32
	TR60M	60W	34
NEW	TR70M	70W	36
	TR100M	100W	38
NEW	TR160M	160W	40
	EC4AW-H6	6W	42
	AC POWER CORD		44
	CABLE & DC PLUG		46
	REQUEST FOR QUOTE		48

CFM21 SERIES

20 WATT, LOW PROFILE 0.8"

Features

- ◆ Universal Input Range 90-264VAC
- ◆ Miniature Size Low Profile 0.8"
- ◆ Industry-Standard Pin Out
- ◆ Efficiency to 85%
- ◆ Option for On-Board, Connector, Screw Terminal or Encapsulated type
- ◆ Continuous Short Circuit Protection
- ◆ Over Voltage Protection
- ◆ No Load Input Power < 0.3W
- ◆ Leakage Current < 0.1mA
- ◆ UL60601-1/IEC60601-1/EN60601-1 Medical Safety Approved
- ◆ UL60950-1/IEC60950-1/EN60950-1 ITE Safety Approved

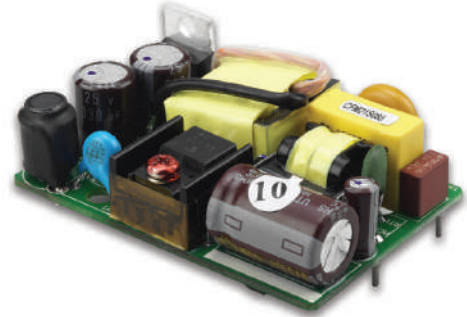

Mechanical Dimensions

All Dimensions in Inches (mm)
 Tolerance Inches: X.XXX=±0.02, X.XXX=±0.01
 Millimeters: X.XX=±0.5, X.XX=±0.25

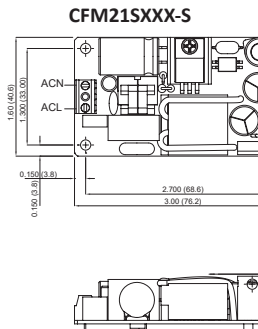
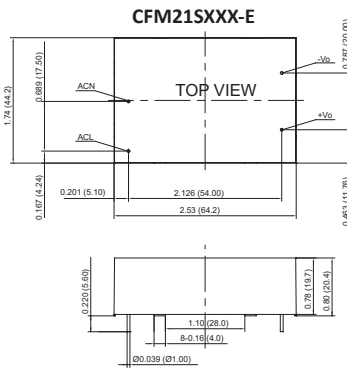
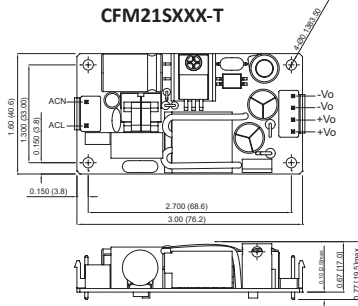
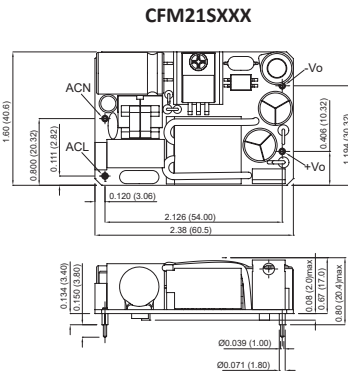

MODEL NUMBER	INPUT VOLTAGE	OUTPUT VOLTAGE	MIN. LOAD	MAX. LOAD	OUTPUT RATED POWER	RIPPLE & NOISE	VOLTAGE ACCURACY	% EFF.
CFM21S033	90-264 VAC	3.3 V	0	4.0 A	13.2 W	50 mV	±1%	75%
CFM21S050	90-264 VAC	5 V	0	4.0 A	20.0 W	50 mV	±1%	80%
CFM21S090	90-264 VAC	9 V	0	2.3 A	20.7 W	90 mV	±1%	81%
CFM21S120	90-264 VAC	12 V	0	1.7 A	20.4 W	100 mV	±1%	83%
CFM21S150	90-264 VAC	15 V	0	1.4 A	21.0 W	100 mV	±1%	84%
CFM21S240	90-264 VAC	24 V	0	0.9 A	21.6 W	100 mV	±1%	85%

Derating Curve

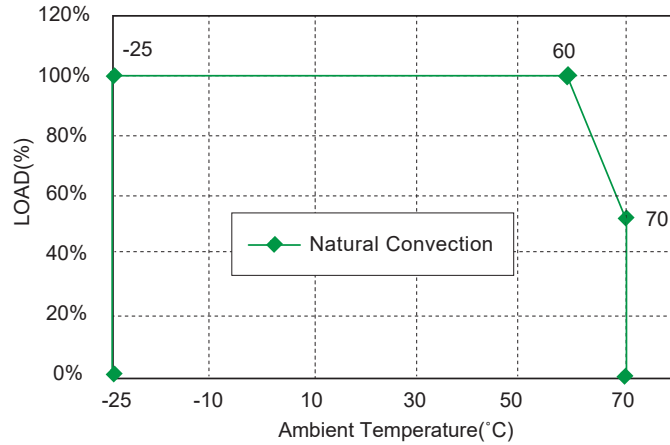

Specifications

All Specifications Typical At Nominal Line, 75% Load, and 25°C Unless Otherwise Noted

INPUT SPECIFICATIONS

Voltage	90-264Vac, 120-370Vdc
Frequency	47 to 63Hz
Input Current	0.3 to 0.5A
Inrush Current	Cold Start @25°C 40A max. @230Vac
Leakage Current	0.1mA max.

OUTPUT SPECIFICATIONS

Voltage Accuracy:	±1.0% max.
Line Regulation (note 3)	±0.5% max.
Load Regulation (note 4)	±1.0% max.
Hold-up Time	10ms typ. @115Vac
Short Circuit Protection	Continuous
Over Voltage Protection (TVS)	115%-140% of nominal output voltage

SAFETY AND EMISSION

CE Directive	2004/108/EC, 93/42/EEC
Emissions	EN60601-1/EN61204-3/ EN55022/ CISPR Class B EN55024
Safety Approvals	UL60601-1, IEC60601-1, EN60601-1, UL60950-1, IEC60950-1, EN60950-1

GENERAL SPECIFICATIONS

Efficiency	see Table
Switching Frequency	100KHz typ.
Isolation	Input to output = 5656VDC
Operating Temperature	-25-70°C (with de-rating)
Storage Temperature	-40-85°C
Cooling	Natural Convection
Humidity	93% RH max. Non condensing
MTBF MIL-STD-217F, GB	650Khrs min.
Dimensions	2.38 x 1.60 x 0.80 inches (60.5 x 40.6 x 20.4 mm) -T: 3.00 x 1.60 x 0.77 inches (76.2 x 40.6 x 19.5 mm) -E: 2.53 x 1.74 x 0.80 inches (64.2 x 44.2 x 20.4 mm) -S: 3.00 x 1.60 x 0.77 inches (76.2 x 40.6 x 19.5 mm)
Weight	50 g, 55 g (-T, -S), 105 g (-E)

NOTE

1. Voltage accuracy is set of 100% rated load.
2. Add a 0.1µF ceramic capacitor and a 10µF E.L. capacitor to output for ripple & noise measuring @20MHz BW.
3. Line regulation is measured from high line to low line with full load.
4. Load regulation is measured from 10% to 100% full load.
5. "T" Version Connection: JST B3P-VH / B4P-VH or equivalent.
6. "S" Version Connection: DECA MB332-381A or equivalent.

CFM21M SERIES

20 WATT SINGLE OUTPUT AC-DC MODULES

Features

- ◆ Universal Input Range 90-264VAC
- ◆ Class II
- ◆ Miniature Size Low Profile 0.8"
- ◆ Industry-Standard Pin Out
- ◆ Efficiency to 87%
- ◆ Option for On-Board, Connector, Screw Terminal or Encapsulated type
- ◆ Continuous Short Circuit Protection
- ◆ Over Voltage Protection
- ◆ No Load Input Power < 0.1W
- ◆ Leakage Current < 100uA
- ◆ UL60601-1/IEC60601-1/EN60601-1 Ed.3.1 Medical Safety Approved
- ◆ 2 MOPP
- ◆ Peak Load 130% (note 8)
- ◆ Meet UL62368/IEC62368/EN62368
- ◆ Meet UL60335-1/IEC60335-1/EN60335-1

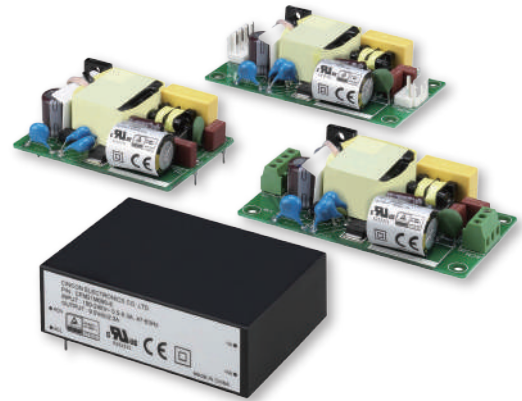

Mechanical Dimensions

All Dimensions In Inches[mm]
 Tolerance: Inches:x.xx= ±0.02,x.xxx= ±0.01
 Millimeters:x.x= ±0.5,x.xx= ±0.25

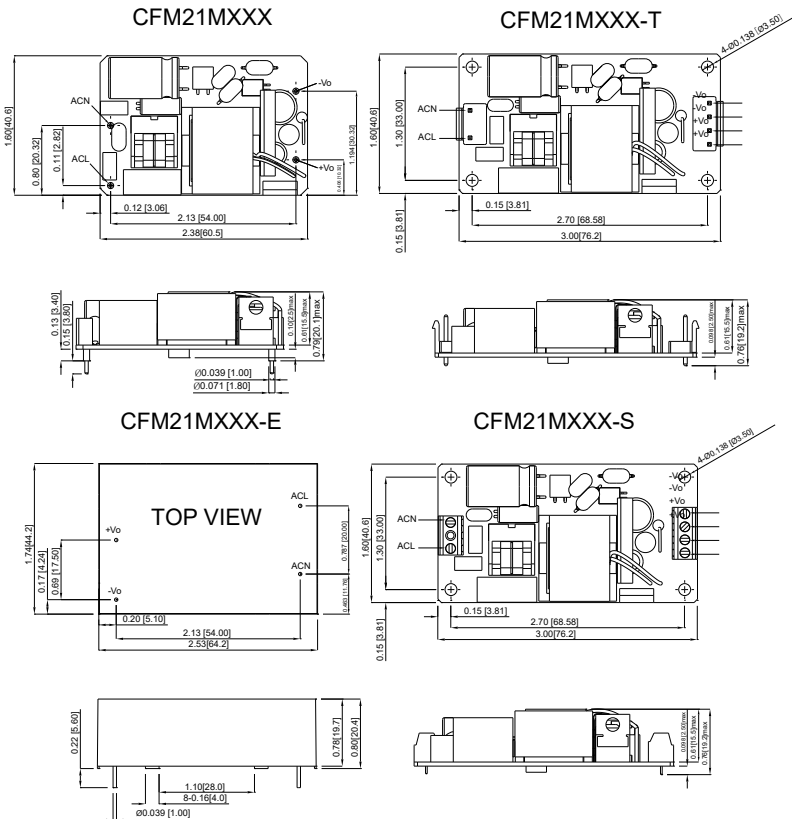

MODEL	OUTPUT VOLTAGE	OUTPUT CURRENT	RIPPLE & NOISE (NOTE 1)	VOLTAGE ACCURACY (NOTE 2)	LINE REGULATION (NOTE 3)	LOAD REGULATION (NOTE 4)	OUTPUT RATED POWER	% EFF
CFM21M050	5.0 V	4.0 A	50mV	±1%	±0.5%	±1.0%	20.0W	81%
CFM21M090	9.0 V	2.3 A	90mV	±1%	±0.5%	±1.0%	20.7W	83%
CFM21M120	12 V	1.7 A	100mV	±1%	±0.5%	±1.0%	20.4W	85%
CFM21M150	15 V	1.4 A	100mV	±1%	±0.5%	±1.0%	21.0W	86%
CFM21M240	24 V	0.9 A	100mV	±1%	±0.5%	±1.0%	21.6W	87%

Derating Curve

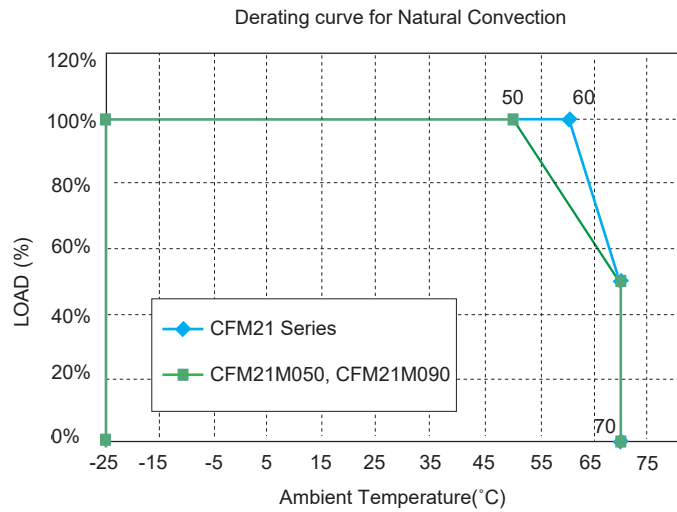

Specifications

All Specifications Typical At Nominal Line, Full Load, and 25°C Unless Otherwise Noted

INPUT SPECIFICATIONS

Voltage	90-264Vac
Frequency	47 to 63Hz
Input Current	0.3 to 0.5A
Inrush Current	Cold Start@25°C 40A max. @230Vac
Leakage Current	70uA Typical - 100uA max

OUTPUT SPECIFICATIONS

Isolation	Input to output = 4000VAC
Hold-up Time	10ms typ. @115Vac
Short Circuit Protection	Continuous
Over Voltage Protection(TVS)	110%-140% of Nominal Output Voltage

SAFETY AND EMISSION

Emission and Immunity (Ed. 4.0)	EN55011 Class B, EN61000-3-2(3) EN60601-1-2 2015, IEC 61000-4-2(3/4/5/6/8/11) IEC60601-1
Safety Approved (Ed.3.1)	ANSI/AAMI ES 60601-1:2005 A1:2012&C1:2009 (R)2012&2010/(R)2012 CAN/CSA-C22.2 NO. 60601-1:14, EN 60601-1: 2006+A11:2011+A1:2013 IEC 60601-1: 2005+A1:2012

GENERAL SPECIFICATIONS

Efficiency	see Table
Switching Frequency	65KHz typ
Operating Temperature	-25-70°C (with de-rating)
Storage Temperature	-40-85°C
Cooling	Natural Convection
Humidity	93% RH max. Non condensing
Operating Altitude	5000m
MTBF	MIL-HDBK-217F, GB 500Khrs min
Dimensions	2.38x1.60x0.80inches (60.5x40.6x20.4mm) -T: 3.00x1.60x0.77inches (76.2x40.6x19.5mm) -E: 2.53x1.74x0.80inches (64.2x44.2x20.4mm) -S: 3.00x1.60x0.77inches (76.2x40.6x19.5mm)
Weight	55g, 60g(-T, -S), 110g(-E)

NOTE

1. Add a 0.1uF ceramic capacitor and a 10uF E.L. capacitor to output for Ripple & Noise measuring @20MHz BW.
2. Voltage accuracy is set of 100% rated load.
3. Line regulation is measured from high line to low line with full load.
4. Load regulation is measured from 10% to 100% full load.
5. T Version Connection: JST B3P-VH / B4P-VH or equivalent.
6. S Version Connection: DECA MB332-381A or equivalent.
7. Typical efficiency at 230VAC and 100% load at 25°C.
8. Peak load 130% lasting < 10 seconds with a maximum duty cycle of 10% at nominal Line.

CFM40M SERIES

40 WATT, 2" X 3" OPEN FRAME

Features

- ◆ Universal Input Range 90-264VAC
- ◆ Medical and ITE Safety Approved
- ◆ Efficiency to 88% Typical
- ◆ Continuous Short Circuit Protection
- ◆ Meets EN55011 and EN55032 Class B
- ◆ No Load Power Consumption < 0.3W
- ◆ 2" x 3" Package
- ◆ Meets 2 MOPP



Mechanical Dimensions

All Dimensions in Inches (mm)
 Tolerance Inches: X.XXX±0.02
 Millimeters: X.XX±0.5

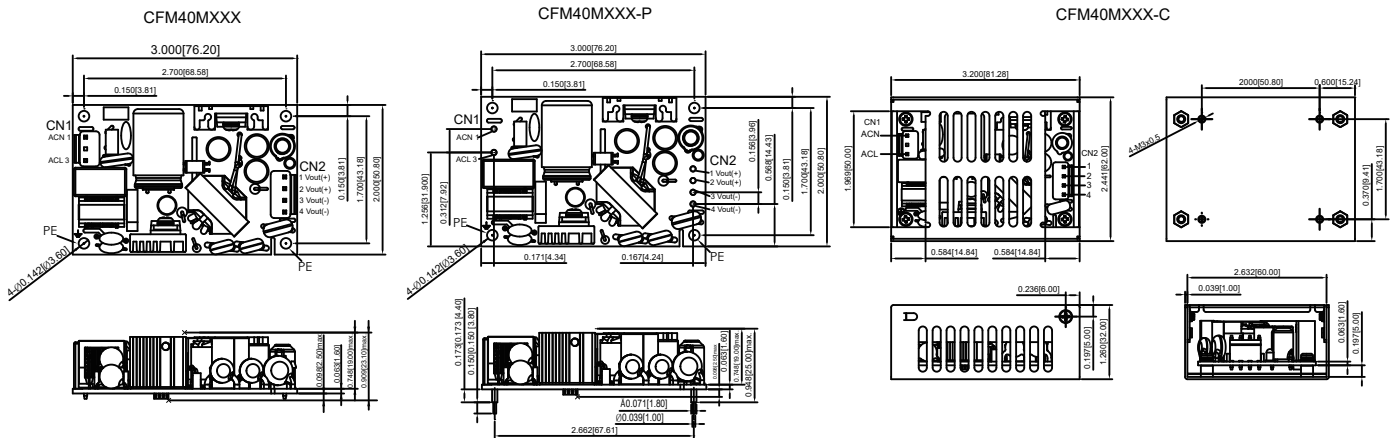

MODEL NUMBER	OUTPUT VOLTAGE	OUTPUT CURRENT	RIPPLE & NOISE (NOTE 2)	VOLTAGE ACCURACY (NOTE 1)	LINE REGULATION (NOTE 3)	LOAD REGULATION (NOTE 4)	% EFF. (Typ.) (NOTE 5)
CFM40M033	3.3 V	6 A	50 mV	±1%	±0.5%	±1%	76%
CFM40M050	5 V	6 A	1%	±1%	±0.5%	±1%	80%
CFM40M090	9 V	4.45 A	1%	±1%	±0.5%	±1%	84%
CFM40M120	12 V	3.34 A	1%	±1%	±0.5%	±1%	86%
CFM40M150	15 V	2.67 A	1%	±1%	±0.5%	±1%	87%
CFM40M240	24 V	1.67 A	1%	±1%	±0.5%	±1%	88%
CFM40M300	30 V	1.33 A	1%	±1%	±0.5%	±1%	88%
CFM40M360	36 V	1.11 A	1%	±1%	±0.5%	±1%	88%
CFM40M480	48 V	0.834 A	1%	±1%	±0.5%	±1%	88%

Derating Curve

Open Frame version: CFM40MXXX

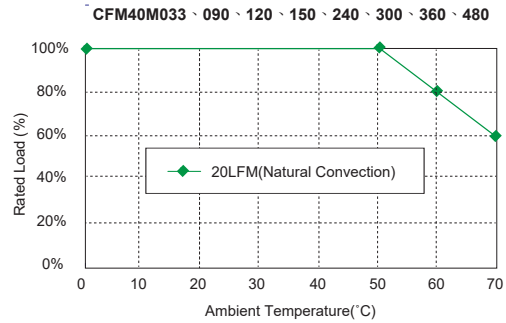
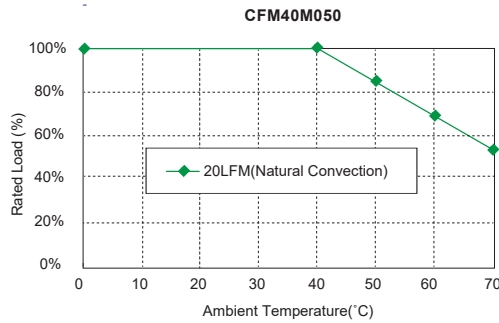

Covered version: CFM40MXXX-C

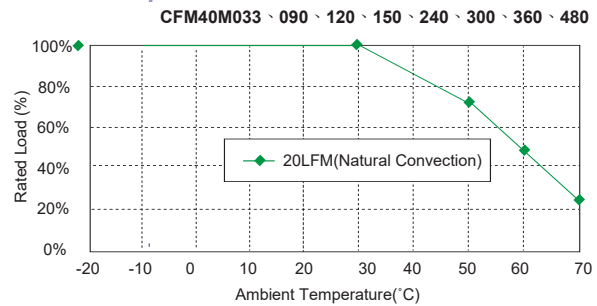
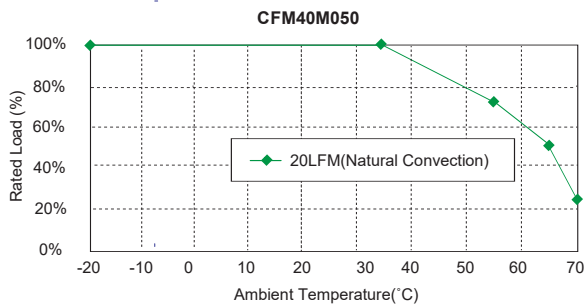

Specifications

All Specifications Typical At Nominal Line, 75% Load, and 25°C Unless Otherwise Noted

INPUT SPECIFICATIONS

Voltage	90-264Vac, 120-370Vdc
Frequency	47 to 63Hz
Inrush Current	Cold start @25°C 60A max. @240Vac
Input Current	100Vac/1A max 240Vac/0.55A max.
Leakage Current	100uA max.

OUTPUT SPECIFICATIONS

Hold-up Time	10ms typ. @115Vac
Short Circuit Protection	Hiccup Mode (Auto Recover)
Over Voltage Protection	TVS Component to Clamp
Temperature Coefficient	±0.05%/°C

GENERAL SPECIFICATIONS

Isolation	Input to output = 4,000Vac
Operating Temperature	0°C-70°C (See Derating Curve)
Storage Temperature	-20°C-85°C
Humidity	93% RH max. Non condensing Natural Convection
Cooling	
Switching Frequency	65KHz Typical
MTBF MIL-HDBK-217F, GB, 25°C/115VAC	200Khrs min.
Altitude	3000m
Dimensions	3.00 x 2.00 x 0.91 inches (76.2 x 50.8 x 23.1 mm) CFM40XXX-P: 3.000x2.000x0.948 Inches (76.20x50.80x25.00 mm) CFM40XXX-C: 3.200x2.441x1.260 Inches (81.28x62.00x32.00 mm)
Weight	CFM40MXXX, CFM40MXXX-P: 90g, CFM40MXXX-C: 176g

SAFETY AND EMISSION

Emission and Immunity (Ed.4.0)

EN55011, EN55032 Class B,
EN55032, FCC CFR 47 Part 15,18
EN61204-3, EN61000-6-1,
EN61000-6-3
EN60601-1-2, EN61000-3-2,
EN61000-3-3
Class I, IEC60601-1:2005 +A1:2012,
EN60601-1:2006/A1:2013
UL ANSI/AAMI ES60601-1:2005,
IEC60950-1, EN60950-1, UL60950-1

Safety(Ed.3.1)

NOTE

1. Voltage accuracy is set at full load.
2. Add a 0.1µF ceramic capacitor and a 10µF E.L. capacitor to output for ripple & noise measurement @20MHz BW.
3. Line regulation is measured from high line to low line with full load.
4. Load regulation is measured from 10% to 100% full load.
5. Typical efficiency at 230VAC and full load 25°C.
6. Standard input and output connectors (CN1 and CN2) wafer with TAIWAN KING PIN TERMINAL PVHI series and mate with JST housing VHR series or equivalent.

CFM60M SERIES

60 WATT, 2" X 4" OPEN FRAME

Features

- ◆ Universal Input Range 90-264VAC
- ◆ Medical and ITE Safety Approved
- ◆ Efficiency to 90%
- ◆ Continuous Short Circuit Protection
- ◆ Meets EN55011 and EN55032 Class B
- ◆ Meets 2 MOPP
- ◆ No Load Power Consumption < 0.5W
- ◆ 2" x 4" Size

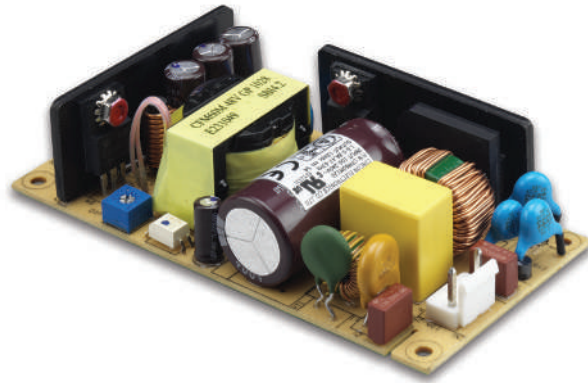

Mechanical Dimensions

All Dimensions are in Inches (mm)
 Tolerance Inches: X.XXX±0.02
 Millimeters: X.XX±0.5

CFM60MXXX

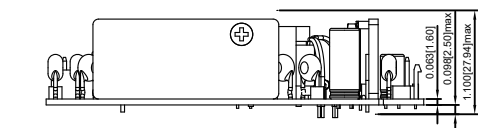
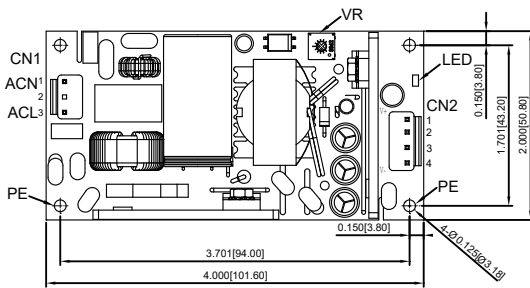

Input Connector CN1	
Pin 1	Line
Pin 2	Not Fitted
Pin 3	Neutral

Output Connector CN2	
Pin 1	+ Vout
Pin 2	+ Vout
Pin 3	- Vout
Pin 4	- Vout

CFM60MXXX-CA

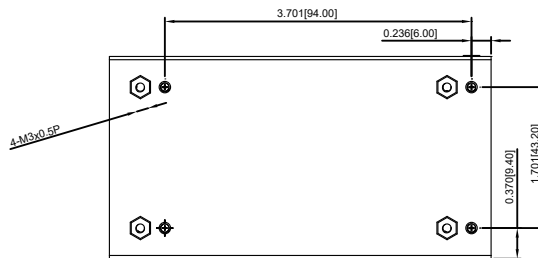
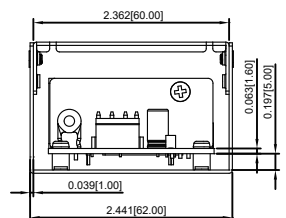
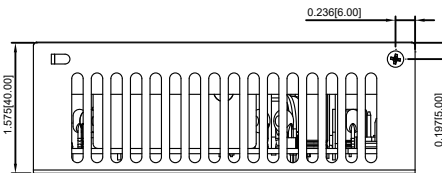
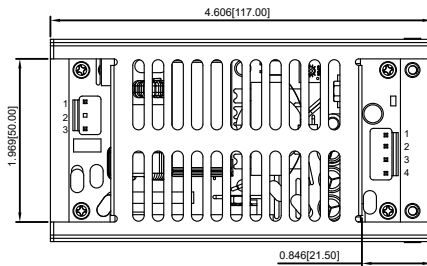

MODEL NUMBER	OUTPUT VOLTAGE	OUTPUT CURRENT	RIPPLE & NOISE (NOTE 2)	VOLTAGE ACCURACY (NOTE 1)	VOLTAGE ADJ. Range	LINE REGULATION (NOTE 3)	LOAD REGULATION (NOTE 4)	% EFF. (Typ.) (NOTE 5)
CFM60M050	5 V	8 A	1%	±1%	4.75-5.25	±0.5%	±1%	82%
CFM60M120	12 V	5 A	1%	±1%	11.4-12.6	±0.5%	±1%	87%
CFM60M150	15 V	4 A	1%	±1%	14.25-15.75	±0.5%	±1%	88%
CFM60M240	24 V	2.5 A	1%	±1%	22.8-25.2	±0.5%	±1%	89%
CFM60M480	48 V	1.25 A	1%	±1%	45.6-50.4	±0.5%	±1%	90%

Derating Curve

Open frame versions

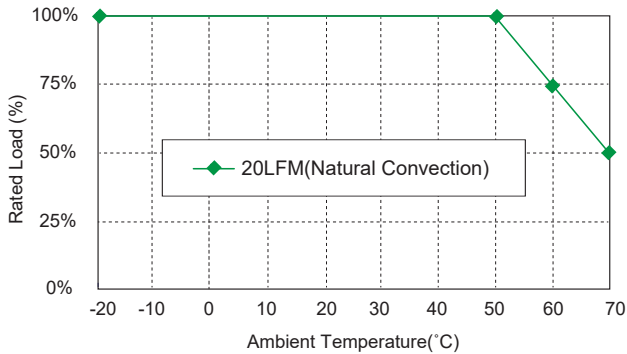

Covered version: CFM60M050-CA

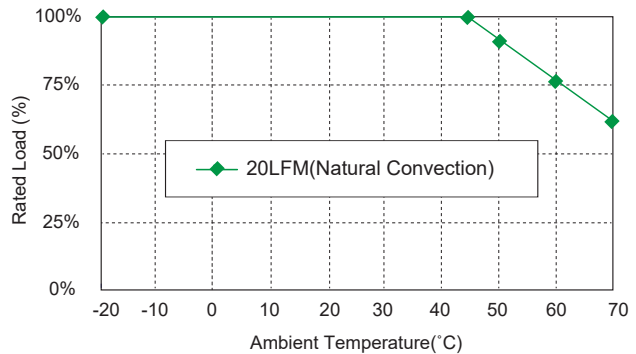

Specifications

All Specifications Typical At Nominal Line, 75% Load, and 25°C Unless Otherwise Noted

INPUT SPECIFICATIONS

Voltage	90-264Vac, 120-370Vdc
Frequency	47 to 63Hz
Inrush Current	Cold Start @25°C 75A max. @240Vac
Input Current	100Vac/1.6A max., 240Vac/0.8Amax.
Leakage Current	100uA max.

OUTPUT SPECIFICATIONS

Hold-up Time	16ms typ. @115Vac
Short Circuit Protection	Hiccup Mode (Auto Recover)
Over Voltage Protection	TVS Component to Clamp
Temperature Coefficient	±0.05%/°C

GENERAL SPECIFICATIONS

Isolation	Input to output = 4000VAC (5,656VDC)
Operating Temperature	-20-70°C (See Derating Curve)
Storage Temperature	-20-85°C
Humidity	93% RH max. Non-Condensing
Cooling	Natural Convection
Switching Frequency	65KHz Typical
MTBF MIL-HDBK-217F, GB, 25°C/115VAC	200Khrs min.
Altitude	3000m
Dimensions	4.000 x 2.000 x 1.100 inches (101.6 x 50.8 x 27.94 mm) CFM60MXXX-CA : 4.606 x 2.362 x 1.575 inches (117.00 x 50.80 x 40.00 mm)
Weight	125 g

SAFETY AND EMISSION

Emission and Immunity (Ed.4.0)	EN55011, EN55032 Class B, EN55024, FCC CFR 47 Part 15, 18 EN61204-3, EN61000-6-1, EN61000-6-3 EN60601-1-2, EN61000-3-2, EN61000-3-3
Safety (Ed.3.1)	IEC60601-1:2005+A1:2012, EN60601-1:2006/A1:2003 UL ANSI/AAMI ES60601-1:2005, IEC60950-1, EN60950-1, UL60950-1

NOTE

- Voltage accuracy is set at full load and 25°C Ta.
- Add a 0.1µF ceramic capacitor and a 10µF E.L. capacitor to output for ripple & noise measuring @20MHz BW.
- Line regulation is measured from 100VAC to 240VAC with full load.
- Load regulation is measured from 10% to 100% full load.
- Typical Efficiency at 230VAC and Full Load at 25°C.
- Standard input and output connectors (CN1 and CN2) wafer with TAIWAN KING PIN TERMINAL PVHI series and mate with JST housing VHR series and JST SVH-21/41T-P1.1 series crimp terminal or Equivalent.
- Optional input and output connectors (CN1 and CN2) wafer with LONG CHU P3060 series and mate with MOLEX housing 5195 series and MOLEX 5194 series crimp terminal or equivalent.
- Safety approvals do not apply to the covered versions, only to the open frame versions.
- Other model refer to application note.

CFM100M SERIES

100 WATT, LOW PROFILE 1.05"

Features

- ◆ Universal Input Range 90-264VAC
- ◆ Medical and ITE Safety Approved
- ◆ 3" x 5" Compact Size
- ◆ Less than 1 U high
- ◆ Industry Standard Pin Out
- ◆ Active PFC Meets EN61000-3-2
- ◆ High Efficiency up to 92%
- ◆ Meets CISPR/FCC Class B
- ◆ Remote Voltage Sense
- ◆ Over Voltage Protection
- ◆ Continuous Short Circuit Protection
- ◆ No Load Power Consumption < 0.5W
- ◆ Meets 2 MOPP



Mechanical Dimensions

All Dimensions are in Inches (mm)
 Tolerance Inches: X.XXX±0.02
 Millimeters: X.XX±0.5

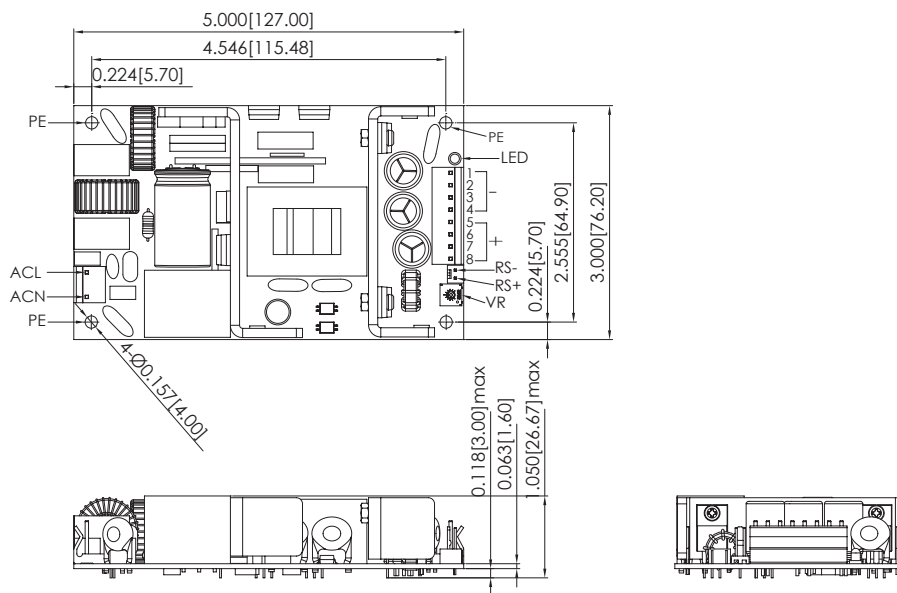

MODEL NUMBER	OUTPUT VOLTAGE	MAX. LOAD	MIN. LOAD	RIPPLE & NOISE (NOTE 1)	VOLTAGE ADJ. RANGE	VOLTAGE ACCURACY (NOTE 2)	LINE REGULATION (NOTE 3)	LOAD REGULATION (NOTE 4)	% EFF. (Typ.) (NOTE 5)
CFM100M050	5 V	20 A	0 A	2%	4.75-5.25	±1%	±0.5%	±1%	83%
CFM100M075	7.5 V	13.4 A	0 A	2%	7.13-7.88	±1%	±0.5%	±1%	87%
CFM100M090	9 V	11.2 A	0 A	1%	8.55-9.45	±1%	±0.5%	±1%	89%
CFM100M120	12 V	8.4 A	0 A	1%	11.4-12.6	±1%	±0.5%	±1%	89%
CFM100M150	15 V	6.7 A	0 A	1%	14.25-15.75	±1%	±0.5%	±1%	90%
CFM100M180	18 V	5.6 A	0 A	1%	17.1-18.9	±1%	±0.5%	±1%	90%
CFM100M240	24 V	4.2 A	0 A	1%	22.8-25.2	±1%	±0.5%	±1%	91%
CFM100M280	28 V	3.6 A	0 A	1%	26.6-29.4	±1%	±0.5%	±1%	90%
CFM100M360	36 V	2.8 A	0 A	1%	34.2-37.8	±1%	±0.5%	±1%	91%
CFM100M480	48 V	2.1 A	0 A	1%	45.6-50.4	±1%	±0.5%	±1%	92%

Derating Curve

CFM100M

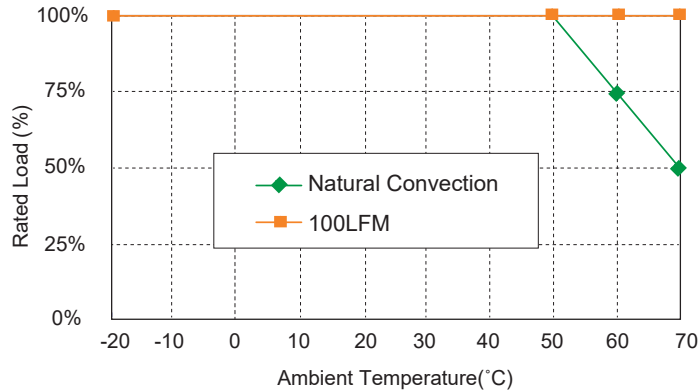

Specifications

All Specifications Typical At Nominal Line, 75% Load, and 25°C Unless Otherwise Noted

INPUT SPECIFICATIONS

Voltage	90-264Vac, 120-370Vdc
Frequency	47 to 63Hz
Inrush Current	80A max. @240Vac
Leakage Current	300uA max.

OUTPUT SPECIFICATIONS

Hold-up Time	16ms typ.
Short Circuit Protection	Hiccup mode (Auto Recovery)
Adjustment Range on Vout	±5%
Over Voltage Protection	Recycle AC input to restart
Temperature Coefficient	±0.05%/°C

GENERAL SPECIFICATIONS

Isolation	Input to output = 5,656VDC
Operating Temperature	-20°C-70°C (see derating curve)
Storage Temperature	-20-85°C
Humidity	93% RH max. Non condensing
Cooling	Natural Convection
Switching Frequency	90KHz Typical
MTBF MIL-HDBK-217F, GB, 25°C/115VAC	200Khrs min.
Altitude	3000m
Dimensions	5.000 x 3.000 x 1.050 inches (127.00 x 76.20 x 26.67 mm)
Weight	270 g (0.6 Pounds)

SAFETY AND EMISSION

Emission and Immunity

EN55024, EN61000-6-1, EN61204-3
EN60601-1-2, EN61000-3-2
Class A, B, C, D, EN61000-3-3
EN55011 Class B, EN55032 Class B,
FCC Part15 Class B
ANSI/AAMI ES60601-1:2005
IEC60950-1, EN60950-1, UL60950-1

Safety

NOTE

- CFM100M050: Add a 0.1µF ceramic capacitor and 220µF E.L. capacitor to output for ripple & noise measuring @20MHz BW. other model: add a 0.1µF ceramic capacitor and a 10µF E.L. capacitor to output for ripple & noise measuring @20MHz BW.
- Voltage accuracy is set at 100% rated load and 25°C Ta.
- Line regulation is measured from high line to low line with full load.
- Load regulation is measured from full to 10% load.
- Typical efficiency at 230VAC and full load at 25°C.
- Standard input and output connectors wafer with LONG CHU P3060 series and mate with MOLEX housing 09-50-1031 and 09-50-1081 or equivalent.
- DC output pin 1, 2, 3, 4: Vout (-), DC output pin 5, 6, 7, 8: Vout (+).

CFM130M SERIES

130 WATT MEDICAL AC-DC POWER SUPPLY WITH PFC

Features

- ◆ Universal Input 80-264Vac
- ◆ 2" x 3" Open Frame Compact Size
- ◆ 100W with Natural Convection
- ◆ 130W with Fan-Cooled
- ◆ No Load Input Power Consumption < 150mW
- ◆ Active PFC Function
- ◆ High Efficiency up to 94%
- ◆ Meets 2 MOPP IEC/EN60335-1
- ◆ EMI Safety Meets Class I & Class II
- ◆ Operating Altitude 5000m

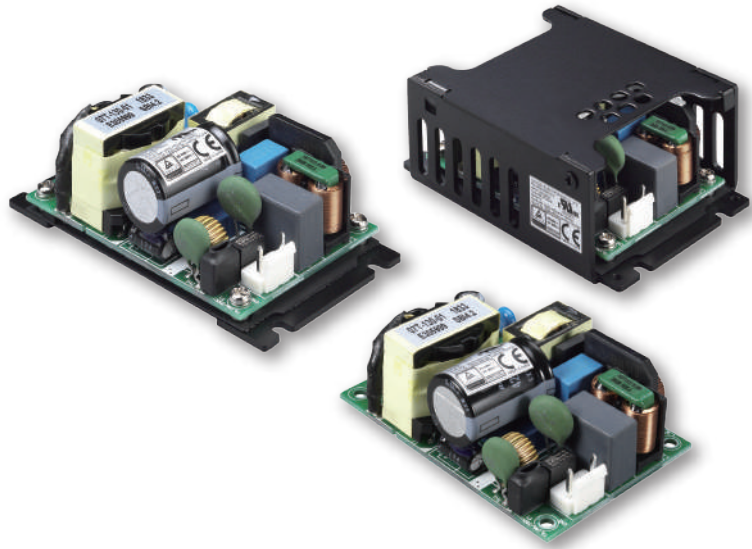

Ordering information

CFM130MXXX - X
 Blank: WAFER
 B: Base Cooling
 C: with Cover

Mechanical Dimensions

All Dimensions In Inches[mm]
 Tolerance Inches:x.xxx = ± 0.02
 Millimeters: x.xx = ± 0.5

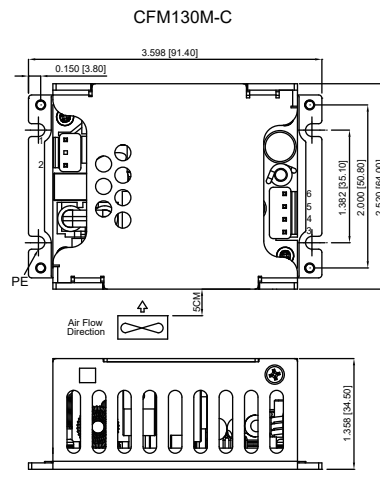
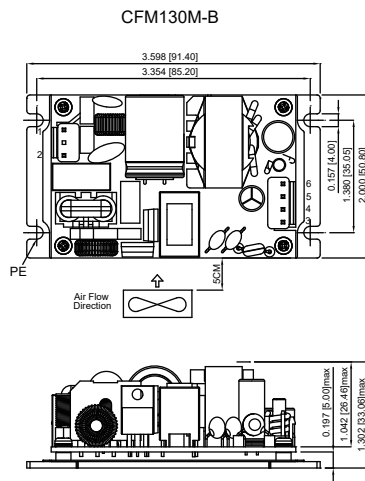
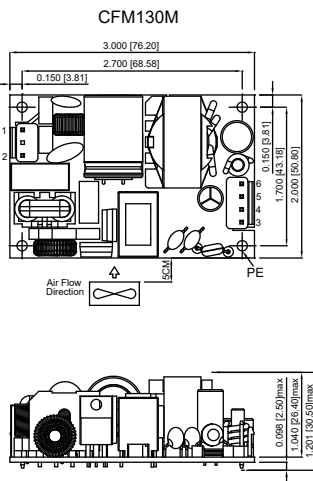

Pin	Function
1	ACL
2	ACN
3	-Vout
4	-Vout
5	+Vout
6	+Vout

MODEL	OUTPUT VOLTAGE	OUTPUT CURRENT		RIPPLE & NOISE (NOTE 2)	VOLTAGE CCURACY (NOTE 1)	LINE REGULATION (NOTE 3)	LOAD REGULATION (NOTE 4)	% EFF. (Typ.) (NOTE 5)
		NATURAL Convection	FAN COOLED (NOTE 7)					
CFM130M120	12V	8.34A	10.8A	1%	±2%	±0.5%	±1%	93%
CFM130M240	24V	4.2A	5.4A	1%	±2%	±0.5%	±1%	93%
CFM130M360	36V	2.8A	3.6A	1%	±2%	±0.5%	±1%	94%
CFM130M480	48V	2.1A	2.7A	1%	±2%	±0.5%	±1%	94%

Derating Curve

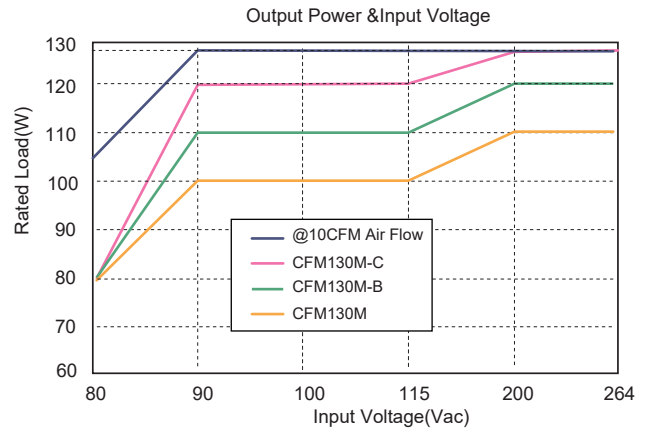
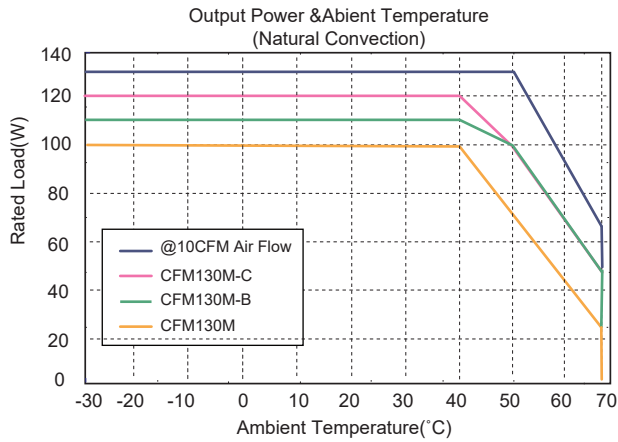

Specifications

All Specifications Typical At Nominal Line, Full Load, and 25°C Unless Otherwise Noted

INPUT SPECIFICATIONS

Voltage	80-264Vac
Frequency	47 to 63Hz
Inrush Current	Cold start @25°C 100A max. @240Vac
Input Current	100Vac/1.5A max., 240Vac/0.8Amax.
Leakage Current	100uA max.

OUTPUT SPECIFICATIONS

Holdup Time	20ms min. @115Vac
Short Circuit Protection	Hiccup Mode (Auto Recover)
Over Voltage Protection	Auto Recover
Temperature Coefficient	±0.05%/°C max

SAFETY AND EMISSION

Emission and Immunity (Ed. 4.0)	EN55011 Class B, IEC61000-3-2 IEC61000-4-2, 3, 4, 5, 6, 8, 11 IEC61000-3-3 FCC Part 18 Class B
Safety (Ed. 3.1)	Class I, Class II, IEC60601-1, EN60601-1 UL ANSI/AAMI ES60601-1

GENERAL SPECIFICATIONS

Isolation	Input to output = 4000VAC
Operating Temperature	-30-70°C (See Derating Curve)
Storage Temperature	-40-85°C
Humidity	93% RH max. Non condensing
Cooling	Natural Convection@100W, 10CFM Air Flow@130W
Altitude	5000m
Dimensions:	3.000x2.000x1.20 inches (76.2x50.8x30.5mm) -B: 3.598x2.000x1.299 inches (91.4x50.8x33.0mm) -C: 3.598x2.520x1.358 inches (91.4x64.0x34.5mm)
Weight	135g, 170g(-B), 218g(-C)

NOTE

1. Voltage accuracy is set at full load.
2. Add a 0.1uF ceramic capacitor and a 10uF E.L. capacitor to output for ripple & noise measuring @20MHz BW.
3. Line regulation is measured from 100Vac to 240Vac with full load.
4. Load regulation is measured from 10% to 100% full load.
5. Typical efficiency at 230 VAC and full load at 25°C.
6. Standard input and output connectors (CN1 and CN2) wafer with TAIWAN KING PIN TERMINAL PVHI series and mate with JST housing XH series or equivalent.
7. Requires 10CFM.

CFM150M SERIES

150 WATT, LOW PROFILE 1.05"

Features

- ◆ Universal Input Range 90-264VAC
- ◆ Medical and ITE Approved
- ◆ 3" x 5" Compact Size
- ◆ Less than 1 U high : 1.05"
- ◆ Industry Standard Pin Out
- ◆ Active PFC Meets EN61000-3-2
- ◆ High Efficiency up to 93%
- ◆ Meets CISPR/FCC Class B
- ◆ Remote Voltage Sense
- ◆ Over Voltage Protection
- ◆ Continuous Short Circuit Protection
- ◆ No Load Power Consumption < 0.5W
- ◆ Meets 2 MOPP

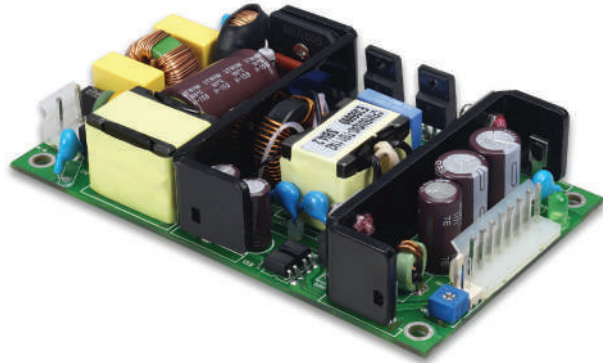

Mechanical Dimensions

All Dimensions are in Inches (mm)

Tolerance Inches: X.XXX±0.02

Millimeters: X.XX±0.5

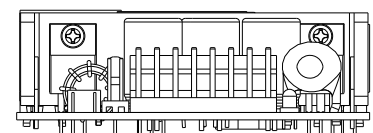
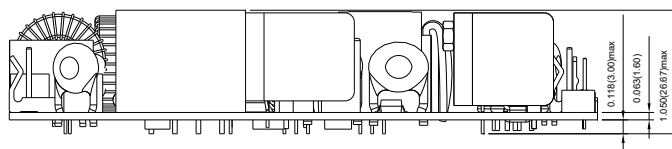
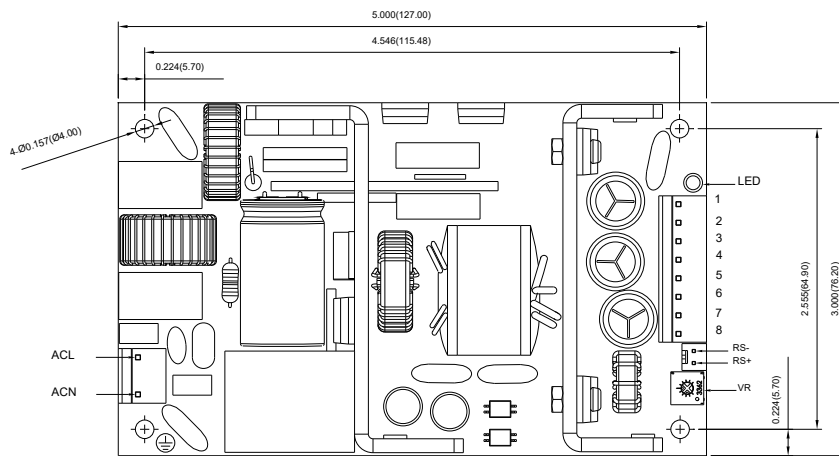

MODEL NUMBER	OUTPUT VOLTAGE	MAX. LOAD	MIN. LOAD	RIPPLE & NOISE (NOTE 1)	VOLTAGE ACCURACY (NOTE 2)	LINE REGULATION (NOTE 3)	LOAD REGULATION (NOTE 4)	% EFF. (Typ.) (NOTE 5)
CFM150M120	12 V	12.5 A	0 A	1%	±1%	±0.5%	±1%	90%
CFM150M240	24 V	6.25 A	0 A	1%	±1%	±0.5%	±1%	92%
CFM150M360	36 V	4.17 A	0 A	1%	±1%	±0.5%	±1%	92%
CFM150M480	48 V	3.13 A	0 A	1%	±1%	±0.5%	±1%	93%

Derating Curve

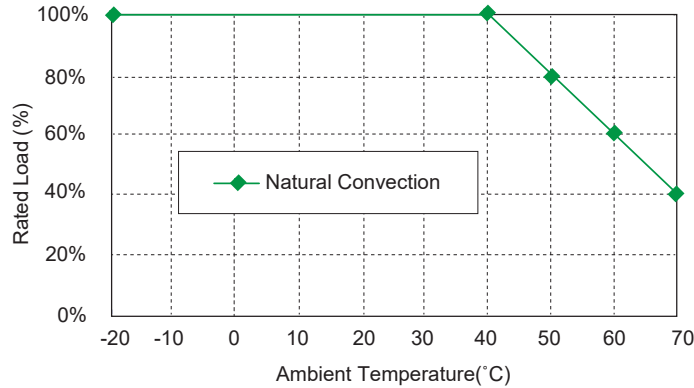

Specifications

All Specifications Typical At Nominal Line, 75% Load, and 25°C Unless Otherwise Noted

INPUT SPECIFICATIONS

Voltage	90-264Vac, 120-370Vdc
Frequency	47 to 63Hz
Inrush Current	110A max. @240Vac
Leakage Current	300uA max.

OUTPUT SPECIFICATIONS

Hold-up Time	16ms typ.
Short Circuit Protection	Hiccup mode (Auto Recovery)
Adjustment Range on Vout	±5%
Over Voltage Protection	Recycle AC input to restart
Temperature Coefficient	±0.05%/°C

GENERAL SPECIFICATIONS

Isolation	Input to output = 5,656VDC
Operating Temperature	-20°C-70°C (see derating curve)
Storage Temperature	-20-85°C
Humidity	93% RH max. Non condensing
Cooling	Natural Convection
Switching Frequency	90KHz Typical.
MTBF MIL-HDBK-217F, GB, 25°C/115VAC	100Khrs min.
Altitude	3000m
Dimensions	5.000 x 3.000 x 1.050 inches (127.00 x 76.20 x 26.67 mm)
Weight	270 g (0.6 Pounds)

SAFETY AND EMISSION

Emission and Immunity

Safety

EN55011 Class B, FCC Part 15 Class B
EN60601-1-2, EN61000-3-2
Class A, B, C, D, EN61000-3-3
Class I, IEC60601-1:2005,
EN60601-1:2006,
ANSI/AAMI ES60601-1:2005
IEC60950-1, EN60950-1, UL60950-1

NOTE

1. Add a 0.1μF ceramic capacitor and 10μF E.L. capacitor to output for ripple & noise measuring @20MHz BW.
2. Voltage accuracy is set at 100% rated load and 25°C Ta.
3. Line regulation is measured from high line to low line with full load.
4. Load regulation is measured from full to 10% load.
5. Typical efficiency at 230VAC and full load at 25°C.
6. Standard input and output connectors wafer with LONG CHU P3060 series and mate with MOLEX housing 09-50-1031 and 09-50-1081 or equivalent.
7. DC output pin 1, 2, 3, 4: Vout (-), DC output pin 5, 6, 7, 8: Vout (+).

CFM200M SERIES

200 WATT, 2" X 4" WITH PFC

Features

- ◆ Universal Input Range 90-264Vac
- ◆ 2"x 4" Open Frame/CFM200M
- ◆ 180W with Natural Convection @220Vac/CFM200M
- ◆ 200W with Natural Convection @220Vac/CFM200MXXX
- ◆ Active PFC Meets EN61000-3-2
- ◆ No Load Power Consumption<0.3W
- ◆ High Power Density Up to 16.9W/Inch³/CFM200M
- ◆ +12V Fan Output
- ◆ High Efficiency up to 93.5%
- ◆ Meet Class II & Class I
- ◆ Meets 2 MOPP



CFM200MXXX (Open Frame)

CFM200MXXXC (With Cover)



Mechanical Dimensions

All Dimensions are in Inches (mm)
 Tolerance Inches: X.XXX±0.02
 Millimeters: X.XX±0.5

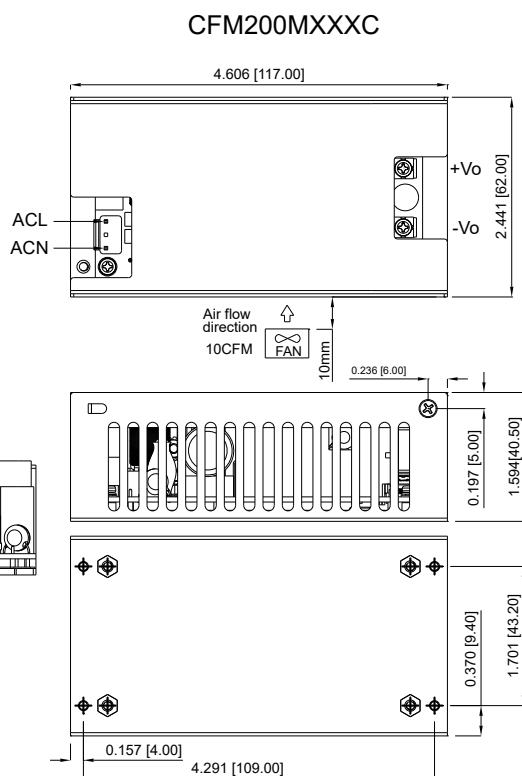
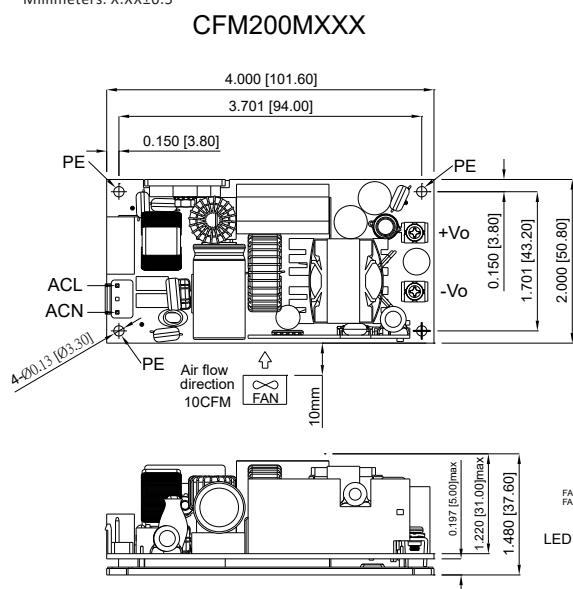

MODEL NUMBER	OUTPUT VOLTAGE	OUTPUT CURRENT	RIPPLE & NOISE (NOTE 1)	VOLTAGE ACCURACY (NOTE 2)	LINE REGULATION (NOTE 3)	LOAD REGULATION (NOTE 4)	% EFF. (Typ.) (NOTE 5)
Main Output Voltage							
CFM200M120	+12 V	16.67 A	150 mVp-p	±2.0%	±0.5%	±1%	92.5%
CFM200M240	+24 V	8.33 A	240 mVp-p	±2.0%	±0.5%	±1%	93.5%
CFM200M480	+48 V	4.17 A	480 mVp-p	±2.0%	±0.5%	±1%	93.5%
Fan Output Voltage							
All	+12 V	0.5 A	-	-	-	-	-
		(NOTE 6)					

Derating Curve

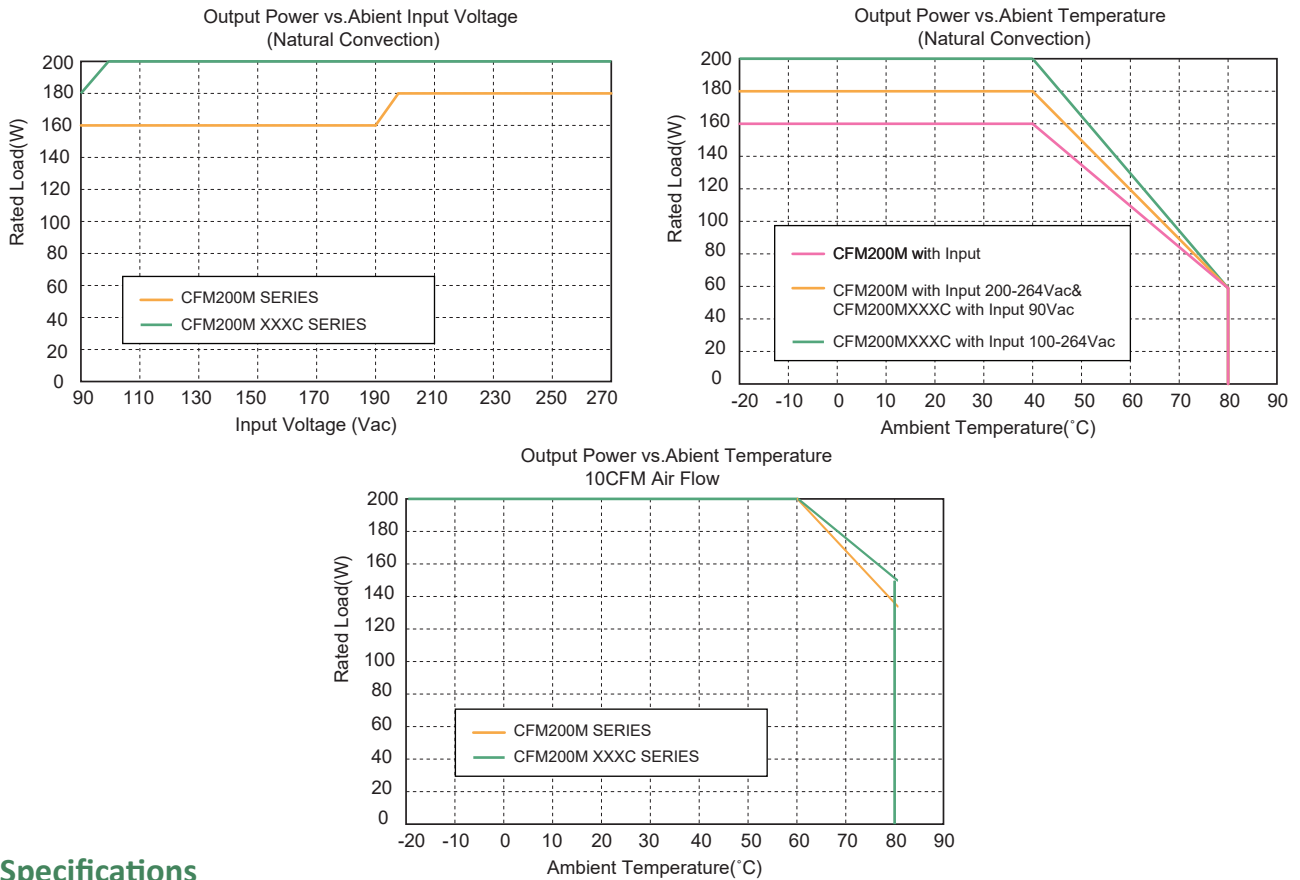

Specifications

All Specifications Typical At Nominal Line, Full Load, and 25°C Unless Otherwise Noted

INPUT SPECIFICATIONS

AC Input Voltage	90-264Vac, 120-370Vdc
Frequency	47 to 63Hz
Inrush Current	100A max. @240Vac
Leakage Current(Earth)	260uA max.
Touch Current (CFM200MXXXC)	260uA typ 300uA max

OUTPUT SPECIFICATIONS

Total Rated Output Power	200W
Hold-up Time	10ms typ.
Over Voltage Protection	Recycle AC input to restart
Short Circuit Protection	Hiccup mode (Auto Recovery)
Temperature Coefficient	±0.05%/°C

SAFETY AND EMISSION

Emission and Immunity (Ed.4.0)	EN55011 Class B, FCC CFR 47 pat 18, IEC61000-3-2, 3, IEC61000-4-2, 3, 4, 5, 6, 8, 11 IEC60601-1:2005+A1:2012 EN60601-1:2006 +A11:2011+A1+A12, ULANSI/AAMI ES60601-1
Safety (Ed.3.1)	

GENERAL SPECIFICATIONS

Isolation	Input to output = 4000VAC
Over Temperature Protection	Auto Recovery
Operating Temperature	-20-80°C (See Derating Curve)
Storage Temperature	-40-85°C
Humidity	93% RH max. Non condensing
Switching Frequency	85KHz Typical
MTBF	MIL-HDBK-217F, GB, 25°C/115VAC 279Khrs typ
Altitude	3000m
Dimensions:	
Open Frame Versions	4.000 x 2.000 x 1.480 inches (101.60 x 50.80 x 37.60 mm)
Covered Versions	4.606 x 2.441 x 1.575 inches (117.00 x 62.00 x 40.50 mm)
Weight	
Open Frame Versions	253 g (0.558 Pounds)
Covered Versions	314 g (0.692 Pounds)

Note

- Add a 0.1µF ceramic capacitor and a 47µF E.L. capacitor to output for ripple & noise measuring @20MHz BW.
- Voltage accuracy is set at 60% rated load and 25°C Ta.
- Line regulation is measured from High Line to Low Line with rated load.
- Load regulation is measured from full to 10% rated.
- Typical efficiency at 230VAC and full load at 25°C.
- 12V/0.3A with nature convection; 12V/0.5A with 10 CFM air flow, tolerance ±10% at main output 100% full load.
- Need an external 1mH choke at input for Class II type to pass EN55011 Class B.
- Input connectors (CN1) wafer with TAIWAN KING PIN TERMINAL PVHI series and mate with JST Housing VHR series or equivalent.
- Fan output connector wafer with TOWNES ENTERPRISE 2001BWseries and mate with JST Housing PHR series and JST SPH series crimp terminal or equivalent.
- Output connectors (Vo+ & Vo- with M3 screw) mate with round terminal and round terminal of the max outer diameter is 6.75mm, max inner diameter is 3.9mm.

CFM300M SERIES

300 WATT, 3" X 5" WITH PFC

Features

- ◆ Universal Input Range 90-264VAC
- ◆ Active PFC Meets EN61000-3-2
- ◆ High Efficiency up to 94%
- ◆ High Power Density up to 14.1W/in³
- ◆ Meets EN55011 Class B
- ◆ Meets 2 MOPP
- ◆ Over Temperature Protection
- ◆ Continuous Short Circuit Protection
- ◆ Remote Voltage Sense
- ◆ PS On/Off Remote Control
- ◆ Power Good & Power Fail Signal
- ◆ +5V Stand-by Output Power
- ◆ 12V Fan Output
- ◆ No Load Power Consumption < 0.3W (note 6)
- ◆ 3"x 5" Size

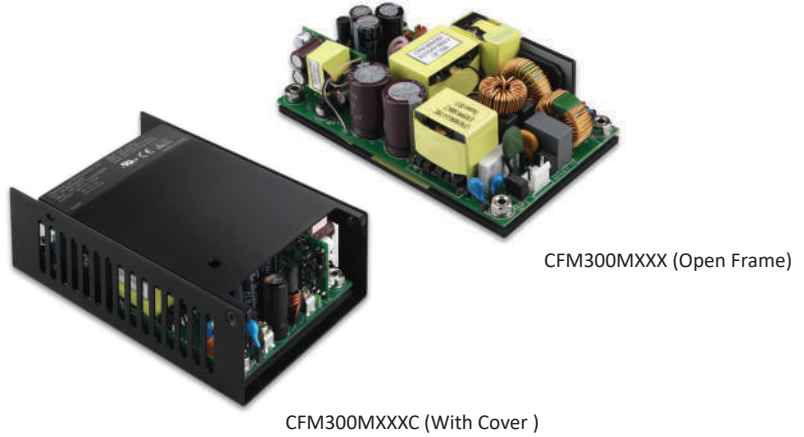

Mechanical Dimensions

All Dimensions are in Inches (mm)
 Tolerance Inches: X.XXX=±0.02
 Millimeters: X.XX=±0.5

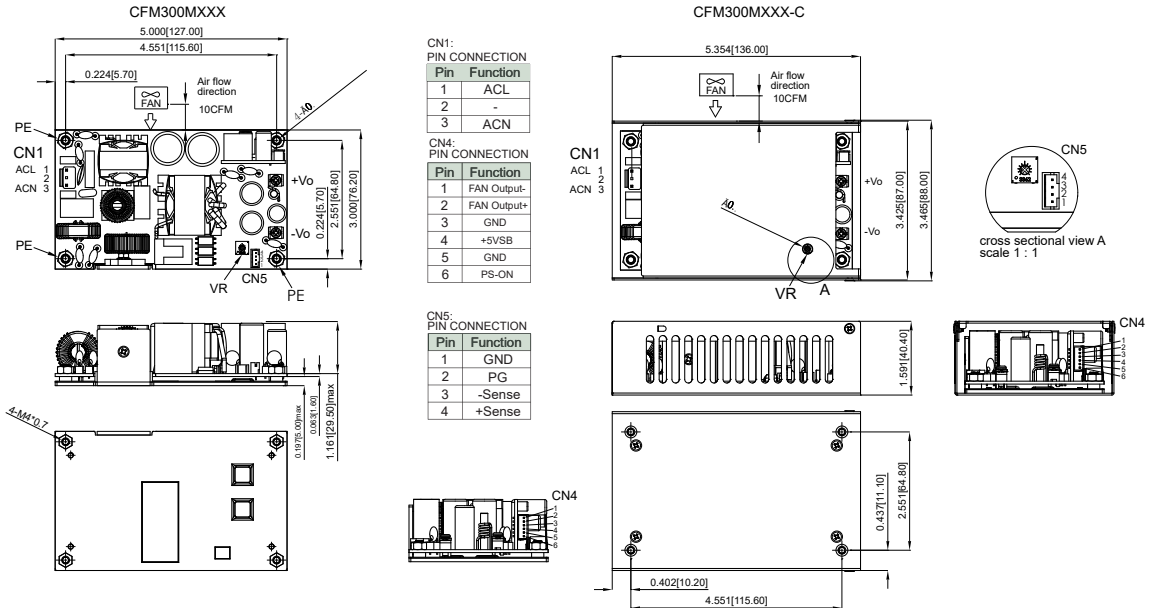

MODEL NUMBER	OUTPUT VOLTAGE	OUTPUT CURRENT RATED 1	OUTPUT CURRENT RATED 2	RIPPLE & NOISE (NOTE 1)	VOLTAGE ACCURACY (NOTE 2)	LINE REGULATION (NOTE 3)	Voltage ADJ. Range	LOAD REGULATION (NOTE 4)	% EFF. (Typ.) (NOTE 5)
Main Output Voltage									
CFM300M120	+12 V	25 A	16.67 A	120 mV	± 1%	± 0.5%	11.4-12.6	± 1%	92.5%
CFM300M240	+24 V	12.5 A	8.34 A	150 mV	± 1%	± 0.5%	22.8-25.2	± 1%	93.5%
CFM300M360	+36 V	8.34 A	5.56 A	150 mV	± 1%	± 0.5%	34.2-37.8	± 1%	93.5%
CFM300M480	+48 V	6.25A	4.17 A	150 mV	± 1%	± 0.5%	45.6-50.4	± 1%	94.0%
Stand-by Output Voltage									
All	+5 V	1 A	0.6 A	100 mV	± 3%	± 1%	--	± 5%	--
Fan Output Voltage									
All	+12 V	0.5 A		--	--	--	--	--	--

Rated 1: Forced air convection
 Rated 2: Natural convection
 For covered versions add "C" to model number or order part no. For example CFM300M120C

Derating Curve

CFM300M Series

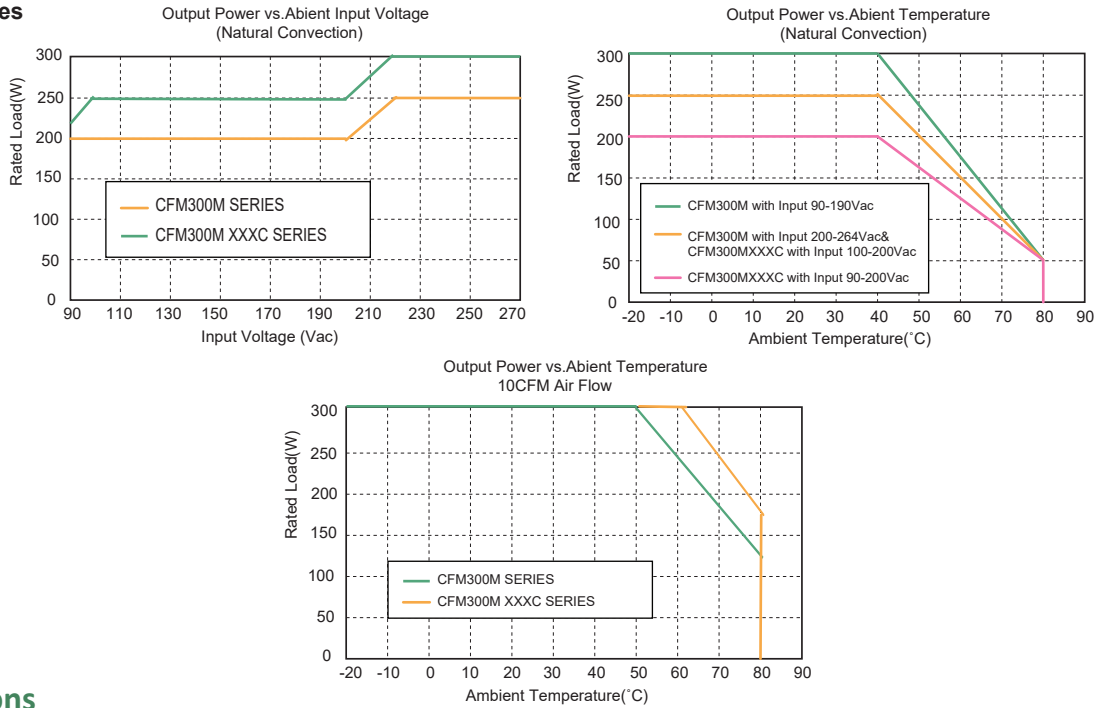

Specifications

All Specifications Typical At Nominal Line, Full Load, and 25°C Unless Otherwise Noted

INPUT SPECIFICATIONS

AC Input Voltage	90-264Vac, 120-370Vdc
Input current	100Vac/4A max., 240Vac/1.8A max.
Frequency	47 to 63Hz
Inrush Current	Cold start @25°C 30A max. @240Vac
Leakage Current	180uA typ., 300uA max

OUTPUT SPECIFICATIONS

Isolation	Input to Output = 4000VAC
Hold-up Time	20ms typ @115Vac
Over Voltage Protection	Latch off
Short Circuit Protection	Hiccup mode (Auto Recovery)
Temperature Coefficient	±0.05%/°C

SAFETY AND EMISSION

Emission and Immunity (Ed.4.0)	EN55011 Class B, FCC CFR 47 Part 18, IEC61000-3-2(3), IEC61000-4-2(3, 4, 5, 6, 8, 11)
Safety(Ed. 3.1)	IEC60601-1:2005+A1:2012 IEN60601-1:2006+A11:2011+A1 +A12, UL ANSI/AAMI ES60601-1

GENERAL SPECIFICATIONS

Operating Temperature	-40~80°C (see Derating Curve)
Storage Temperature	-40~85°C
Over Temperature Protection	Auto Recovery
PS-On Signal	Power on: PS-ON ≤ 2V (note 12) Power off: PS-ON = 11-16V, Open Circuit 250ms > PG > 50ms
Power Good/Power Fail (PG)	The TTL goes high with 50ms to 250ms after power set up The TTL goes low at least 5ms before Vo below 90% rated value
Humidity	93% RH max. non-condensing
Altitude	3000m
Cooling	Natural convection for 200W-250W (See Derating Curve) forced air convection (10CFM) for 300W
Switching Frequency	60-80KHz typ. @ Full load
MTBF	MIL-HDBK-217F, GB, 25°C/115VAC 160Khrs.typ
Dimensions:	
Open Frame	5.000 x 3.000 x 1.421 inches (127.00 x 76.20 x 36.1 mm)
With Cover	5.355 x 3.425 x 1.591 inches (136.00 x 87.00 x 40.40 mm)
Weight	
Open frame versions	420g (0.925 Pounds)
-C covered versions	550g (1.21 Pounds)

NOTE

- Add a 0.1µF ceramic capacitor and a 10µF E.L. capacitor to output for ripple & noise measuring @20MHz BW.
- Voltage accuracy is set at 100% rated load and 25°C.Ta.
- Line regulation is measured from high line to low line with rated load.
- Load regulation is measured from full to 10% load.
- Typical efficiency at 230 VAC and full load at 25°C.
- No load power consumption < 0.3W by PS On/Off remote control.
- Input connector (CN1) wafer with TAIWAN KING PIN TERMINAL PVHI series and mate with JST housing VHR series or equivalent.
- Optional Input connector (CN1) wafer with LONG CHU P3060 series and mate with MOLEX housing 5195 series or equivalent.
- Output connector CN4 wafer with JST PH series and mate with JST housing PH series or equivalent.
- Output connector CN5 wafer with TAIWAN KING PIN TERMINAL P110I series and mate with JST housing PH series or equivalent.
- Output connectors (Vo+ & Vo- with M3 screw) mate with round terminal and round terminal of the max outer diameter is 6.75mm, max inner diameter is 3.9mm.
- PS-ON and GND short, IPS-ON = 4.5 mA typical.

CFM351M SERIES

350 WATT, OPEN FRAME

Features

- ◆ Universal Input Range 90-264VAC
- ◆ Meets EN60601-1 and EN55011 Class B
- ◆ 350W with Free Air Convection @ 220VAC
- ◆ Active PFC Meets EN61000-3-2 Class D
- ◆ High Efficiency Up to 93% Typical
- ◆ Remote Voltage Sense
- ◆ PS On/Off Remote Control
- ◆ +5V Stand-By Output Power
- ◆ 12V Fan Output
- ◆ Meets 2 MOPP



Mechanical Dimensions

All Dimensions in Inches (mm)
 Tolerance Inches: X.XXX=±0.04, X.XXX=±0.010
 Millimeters: X.X=±1.0, X.XX=±0.50.25

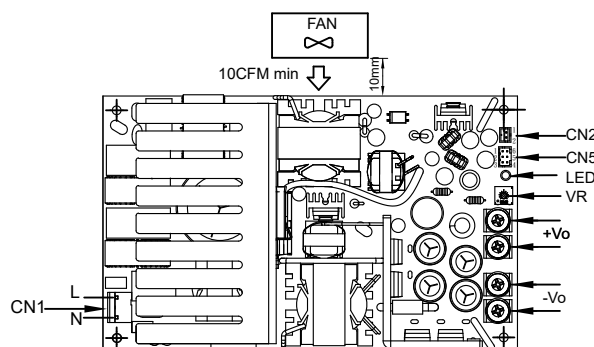
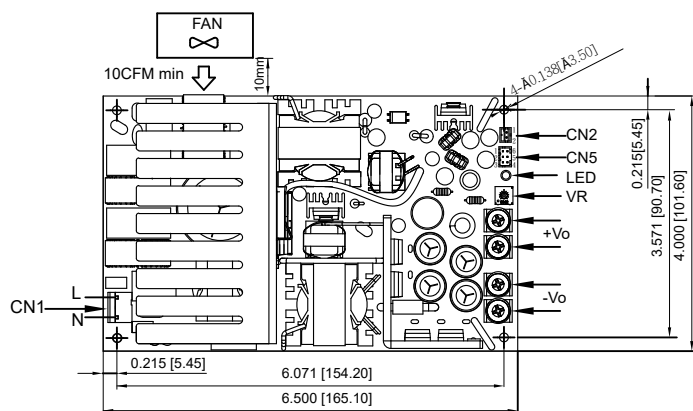

FAN location for CFM351M050 only

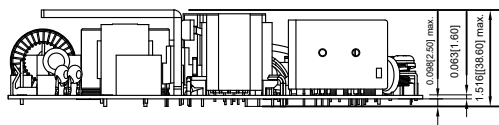

CN5: PIN CONNECTION

Pin	Function	Pin	Function
1	GND	4	-SENSE
2	+5VSB	5	ENABLE
3	+SENSE	6	GND

CN2: PIN CONNECTION

Pin	Function
1	FAN Output+
2	FAN Output-

MODEL NUMBER	OUTPUT VOLTAGE	OUTPUT CURRENT(A) RATED 1	OUTPUT CURRENT(A) RATED 2	RIPPLE & NOISE	VOLTAGE ADJ.RANGE	VOLTAGE ACCURACY	LINE REG.	LOAD REG.	% EFF. (Typ.)
Main Output Voltage									
CFM351M050	+5 V	60	40	100 mVp-p	4.75-5.25	±1.0%	±0.5%	±1%	88%
CFM351M120	+12 V	29.2	25	120 mVp-p	11.4-12.6	±1.0%	±0.5%	±1%	92%
CFM351M240	+24 V	14.6	12.5	150 mVp-p	22.8-25.2	±1.0%	±0.5%	±1%	93%
CFM351M480	+48 V	7.3	6.25	150 mVp-p	45.6-50.4	±1.0%	±0.5%	±1%	93%
Stand-by Output Voltage									
All	+5.0 V	0.3	0.3	----	----	----	----	----	----
Fan Output Voltage									
All	+12.0 V	0.3	0.3	----	----	----	----	----	----

Note: 1. RATED1: 10CFM Air Flow
 2. RATED2: Natural Convection (at 110 -200 Vac, refer to derating curve)

Derating Curve

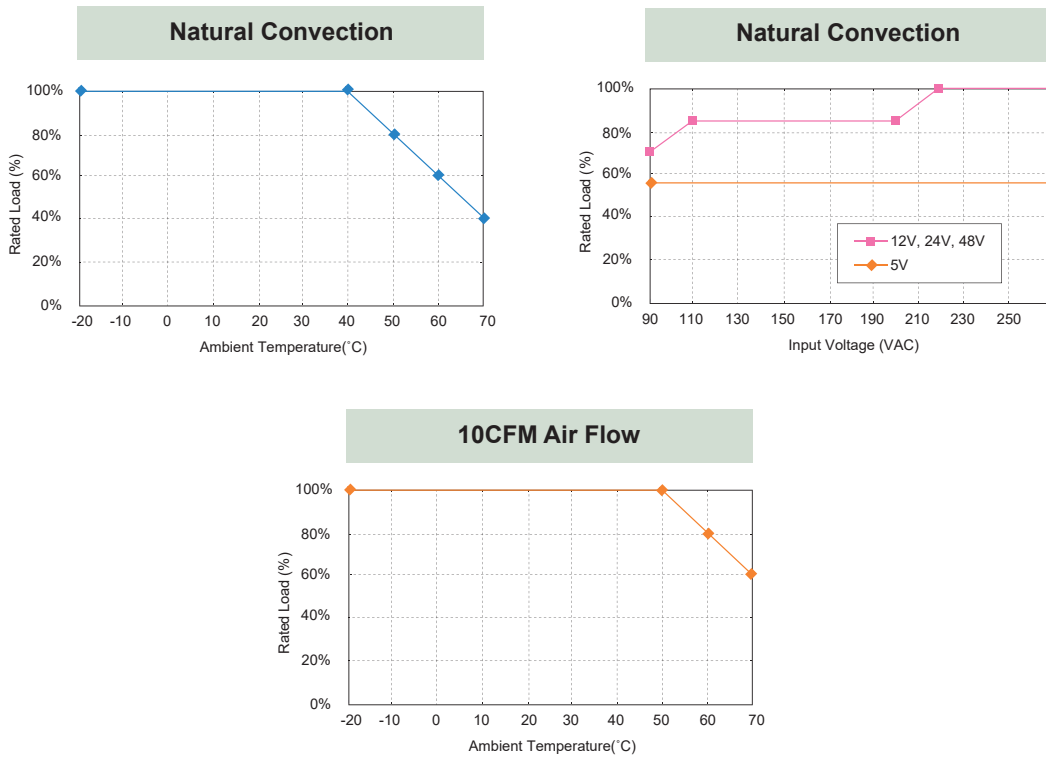

Specifications

All Specifications Typical At Nominal Line, Full Load, and 25°C Unless Otherwise Noted

INPUT SPECIFICATIONS

AC Input Voltage	90-264Vac, 120-370Vdc
Frequency	47 to 63Hz
Inrush Current	50A max. @240Vac
Leakage Current @ 264Vac	300uA max.

OUTPUT SPECIFICATIONS

Total Rated Output Power	350W
Remote Voltage Sense	Compensates for Wire Voltage Drop
Adjustment Range on Vout	±5%
Hold-up Time	16ms typ.
Over Voltage Protection	Recycle AC Input to restart
Short Circuit Protection	Hiccup mode (Auto Recovery)
Temperature Coefficient	±0.05%/°C

GENERAL SPECIFICATIONS

Isolation	Input to output = 5656VDC
Operating Temperature	-20-70°C (See Derating Curve)
Storage Temperature	-40-85°C
Humidity	93% RH max. Non condensing
Switching Frequency	55KHz Typical
MTBF MIL-HDBK-217F, GB, 25°C/115VAC	100Khrs min.
Altitude	3000m
Dimensions	6.500 x 4.000 x 1.516 inches (165.00 x 101.60 x 38.60 mm)
Weight	640 g (1.42 Pounds)

SAFETY AND EMISSION

Emission and Immunity(Ed. 4.0)	EN55011 Class B, FCC CFR 47 Part 15, EN60601-1-2, IEC61000-3-2, 3, IEC61000-4-2, 3, 4, 5, 6, 8, 11 IEC60601-1:2005,+A1:2012, EN60601-1:2006,+A11:2011+A1+A12, ANSI/AAMI ES60601-1:2005
Safety(Ed. 3.1)	

NOTE

1. Add a 0.1μF ceramic capacitor and a 47μF E.L. capacitor to output for Ripple & Noise measuring @20MHz BW.
2. Voltage accuracy is set at 60% rated load and 25°C.Ta.
3. Line regulation is measured from high line to low line with rated load.
4. Load regulation is measured at 60%±40% rated.
5. CN1: LONG CHU P3060 Series or Equivalent
CN2: JST B2B-PH-K-S or equivalent
CN5: LONG CHU P220V Series or Equivalent

CFM500M SERIES

500 WATT AC-DC POWER SUPPLY WITH PFC

Features

- ◆ Universal Input Range 85-264Vac
- ◆ Active PFC Meets EN61000-3-2
- ◆ High Efficiency up to 94%
- ◆ Meets IEC/EN60335
- ◆ Meets 2MOPP
- ◆ Over Temperature Protection
- ◆ Continuous Short Circuit Protection
- ◆ Remote Voltage Sense
- ◆ PS On/Off Remote Control
- ◆ Power Good & Power Fail Signal
- ◆ +5V Stand-by Output Power
- ◆ 12V Fan Output
- ◆ No Load Power Consumption<0.5W (NOTE 6)
- ◆ 3"x 5" Size
- ◆ Class I

PRELIMINARY



Mechanical Dimensions

All Dimensions are in inches[mm]
Tolerance: Inches: X.XXX±0.02
Millimeters: X.XX±0.5

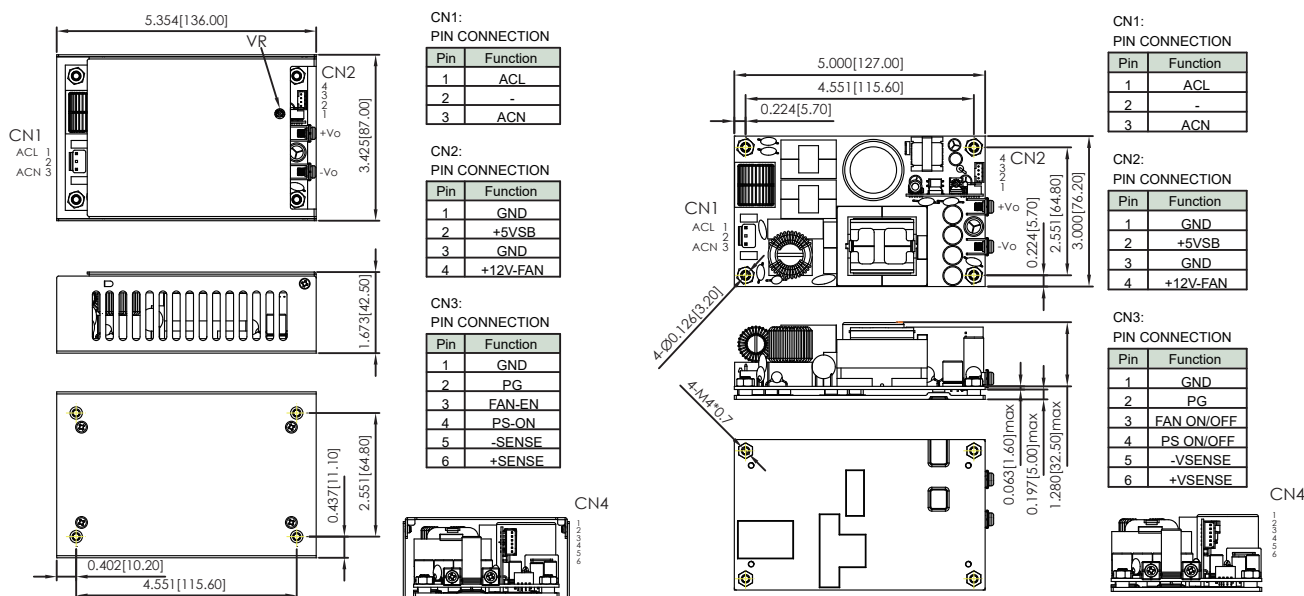

MODEL NUMBER	OUTPUT VOLTAGE	OUTPUT RATED1	CURRENT RATED2	RIPPLE & NOISE (NOTE 1)	VOLTAGE ACCURACY (NOTE 2)	LINE REGULATION (NOTE 3)	Voltage ADJ. Range	LOAD REGULATION (NOTE 4)	% EFF. (Typ.) (NOTE 5)
Main Output Voltage									
CFM500M120	+12 V	41.67 A	20.83 A	120mV	±1%	±0.5%	11.4-12.6	±1%	91.5%
CFM500M240	+24 V	20.83 A	13.33 A	150mV	±1%	±0.5%	22.8-25.2	±1%	93.0%
CFM500M360	+36 V	13.89 A	8.89 A	150mV	±1%	±0.5%	34.2-37.8	±1%	94.0%
CFM500M480	+48 V	10.42 A	6.67 A	150mV	±1%	±0.5%	45.6-50.4	±1%	94.0%
Stand-by Output Voltage									
ALL	+5 V	1 A	0.6 A	100mV	±3%	±1%	-	±5%	-
Fan Output Voltage									
ALL	+12 V	0.5 A	0.5 A	-	-	-	-	-	-

Note:
Rated 1: Forced air convection
Rated 2: Natural convection
For covered versions add "C" to model number or order part no. For example CFM500M120C

Derating Curve

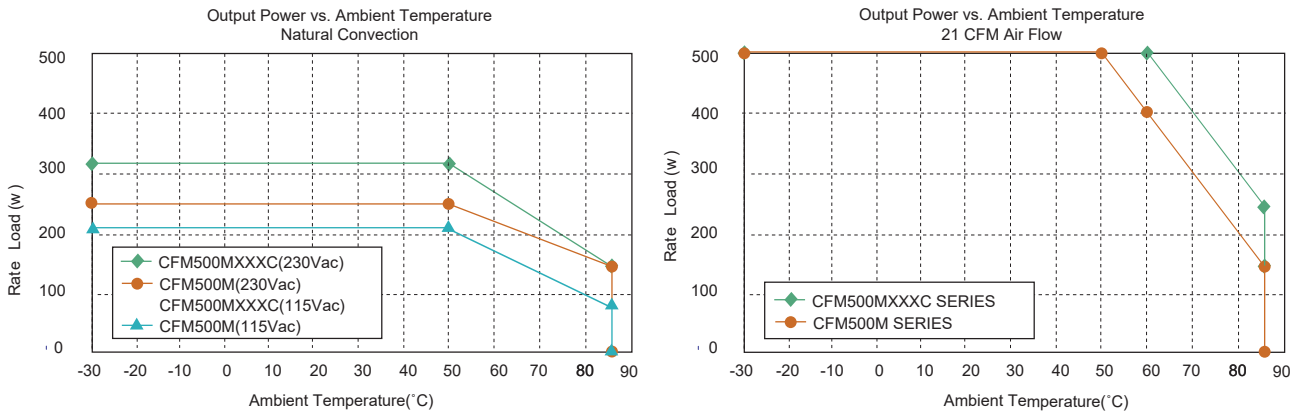

Specifications

All Specifications Typical At Nominal Line, Full Load, and 25°C Unless Otherwise Noted

INPUT SPECIFICATIONS

AC Input Voltage	85-264Vac
Frequency	47 to 63Hz
Inrush Current	Cold start @25°C 50A max. @240Vac
Input Current	100Vac/6A max., 240Vac/3A max.
Leakage Current	100uA max.

OUTPUT SPECIFICATIONS

Isolation	Input to Output = 4000VAC
Holdup Time	16ms typ. @115Vac
Over Voltage Protection	Yes
Short Circuit Protection	Hiccup mode(Auto Recovery)
Temperature Coefficient	±0.05%/°C

SAFETY AND EMISSION

Emission and Immunity (Ed. 4.0)	EN55011 Class B, FCC CFR 47 Part 18 IEC61000-3-2(3), IIEC61000-4-2(3, 4, 5, 6, 8, 11) IEC60601-1:2005+A1:2012
Safety(Ed.3.1)	EN60601-1:2006+A11:2011+A1 +A12, UL ANSI/AAMI ES60601-1

GENERAL SPECIFICATIONS

Operating Temperature	-30 -85°C(see derating curve)
Storage Temperature	-40 -85°C
Humidity	93% RH max. Non condensing Natural convection for 250W (see de-rating curve)
Cooling	forced air convection(21CFM) for 500W
Over Temperature Protection	Auto Recovery
PS-On Signal	Power On.....PS-On ≤ 2V (note 12) Power Off.....PS-ON=11-16V, Open Circuit
Power Good/Power Fail(PG)	250ms>PG>50ms The TTL goes high with 50ms to 250ms after power set up The TTL goes low at least 5ms before Vo below 90% rated value
MTBF	MIL-HDBK-217F, GB, 25°C/115VAC
Switching Frequency	T.B.D.
Altitude	5000m
Dimensions	
Open frame versions	5.000x3.000x1.540 inches (127.00x76.20x39.10mm)
-C covered versions	5.354x3.425x1.673 inches (136.00x87.00x42.50mm)
Weight	
Open frame versions	T.B.D.
-C covered versions	T.B.D.

NOTE

- Add a 0.1uF ceramic capacitor and a 10uF E.L. capacitor to output for ripple & noise measuring @20MHz BW
- Voltage accuracy is set at 100% rated load and 25°C.Ta.
- Line regulation is measured from high line to low line with rated load.
- Load regulation is measured from full to 10% load.
- Typical efficiency at 230 VAC and full load at 25°C
- No load power consumption<0.5W by PS on/off remote control.
- Input connector (CN1) wafer with TAIWAN KING PIN TERMINAL PVHI series and mate with JST housing VHR series or equivalent.
- Optional Input connector (CN1) wafer with LONG CHU P3060 series and mate with MOLEX housing 5195 series or equivalent.
- Output connector CN4 wafer with JST PH series and mate with JST housing PH series or equivalent.
- Output connector CN5 wafer with TAIWAN KING PIN TERMINAL P110I series and mate with JST housing PH series or equivalent.
- Output connectors (Vo+ & Vo- with M3 screw) mate with round terminal and round terminal of the max outer diameter is 6.75mm, max inner diameter is 3.9mm.
- PS-ON and GND short, IPS-ON =4.5 mA typical.

TR15RAM SERIES

1.5 WATT, MEDICAL SWITCHING ADAPTER

Features

- ◆ Universal Input Range 90-264VAC
- ◆ Meets EN60601-1 and EN55011 Class B
- ◆ Continuous Short Circuit Protection
- ◆ Interchangeable AC Plugs
- ◆ Over Voltage Protection
- ◆ Efficiency & Standby Power Meet Level V (Output Cable Length \leq 1800mm)
- ◆ Meets 2 MOPP



Ordering information

TR15RAMXXX	- XX	E XX	- XX	-BK
Model No.	DC Plug Type	DC Cable Length and Type	Color of Overmold Case	
		01: 720mm	BE: Blue	
		02: 1220mm	GY: Gray	
		03: 1800mm	RD: Red	
		11: 7200mm with Ferrite Core	PE: Purple	
		12: 1220mm with Ferrite Core	OR: Orange	
		13: 1800mm with Ferrite Core		
		* 18AWG / UL1185		

Mechanical Dimensions

All Dimensions are in Inches (mm)
Tolerance Inches: X.XXX±0.02
Millimeters: X.XX±0.5

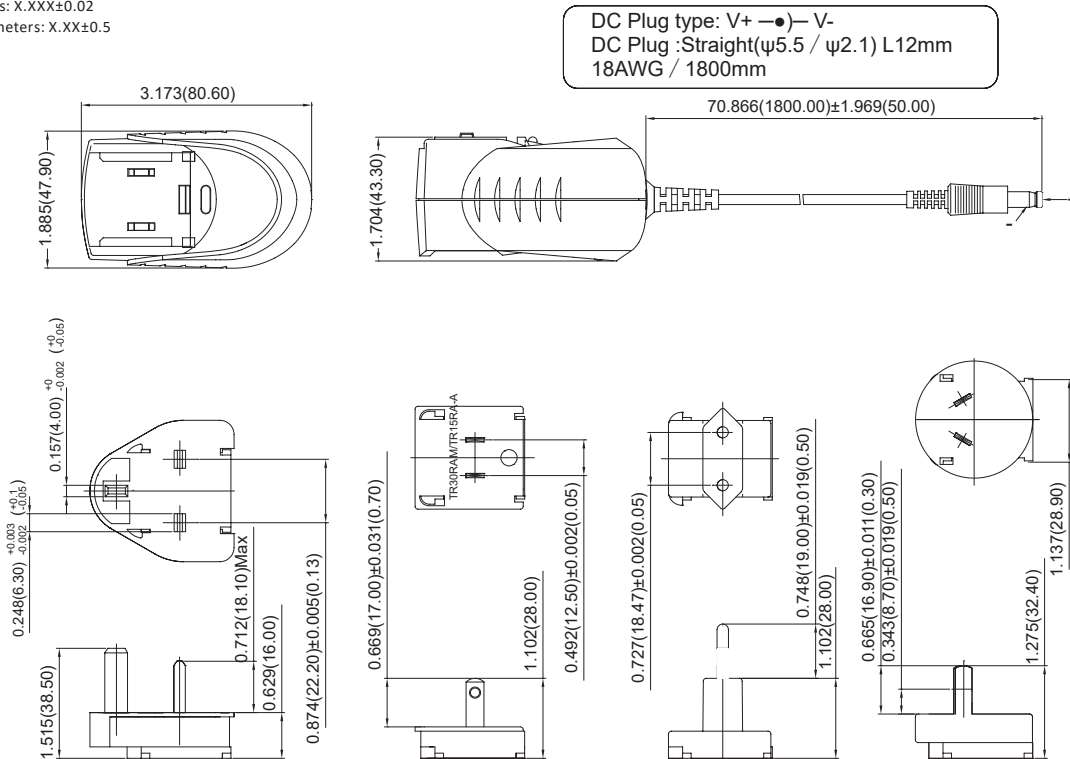

MODEL NUMBER	OUTPUT VOLTAGE	OUTPUT CURRENT (NOTE 1)	RIPPLE & NOISE (NOTE 2)	VOLTAGE ACCURACY (NOTE 3)	LINE REGULATION (NOTE 4)	LOAD REGULATION (NOTE 5)	% EFF. (Typ.)
TR15RAM050	5 V	2.0 A	1%	±3%	±1%	±4%	73%
TR15RAM120	12 V	1.1 A	1%	±2%	±1%	±2%	82%
TR15RAM150	15 V	1.0 A	1%	±2%	±1%	±2%	81%
TR15RAM240	24 V	625 mA	1%	±2%	±1%	±2%	82%

Derating Curve

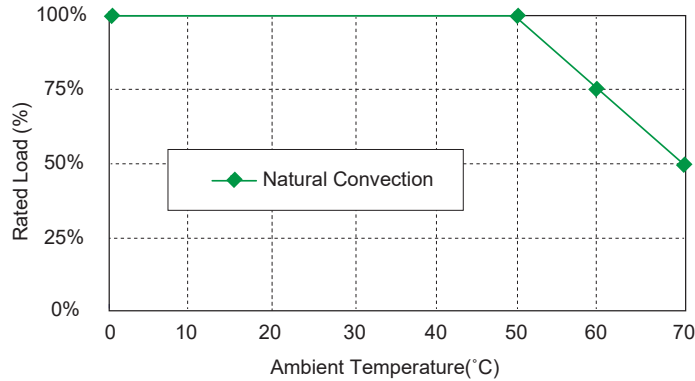

Specifications

All Specifications Typical At Nominal Line, 75% Load, and 25°C Unless Otherwise Noted

INPUT SPECIFICATIONS

Voltage	90-264Vac, 120-370Vdc
Frequency	47 to 63Hz
Inrush Current	50A max. @240Vac
Leakage Current	0.1mA max.

SAFETY AND EMISSION

Emission and Immunity(Ed. 4.0)	EN55011 Class B, FCC47 CFR Part 15 EN60601-1-2, EN61000-3-2, 3, IEC61000-4-2, 3, 4, 5, 6, 8, 11 IEC60601-1:2005+A1 EN60601-1:2006+A11:2011+A1+A12, UL ANSI/AAMI ES60601-1: 2005
Safety(Ed. 3.1)	

OUTPUT SPECIFICATIONS

Hold-up Time	10ms typ. @115Vac
Temperature Coefficient	±0.05%/°C
Short Circuit Protection	Continuous (Auto Recovery)
Over Voltage Protection	TVS Component to Clamp

NOTE

1. Add a 0.1μF ceramic capacitor and a 10μF E.L. capacitor to output for ripple & noise measuring @20MHz BW.
2. Voltage setpoint at 60% full load.
3. Line regulation measured from 100VAC to 240VAC full load.
4. Load regulation measured from 60% to full load and from 60% to 20% load (60% +/- 40% load).
5. Typical efficiency at 230VAC and full load at 25°C.
6. "Various TR Series adapters are PSE certified. PSE certification alone is not sufficient for importation into Japan. A valid PSE mark must contain the name of the importer as shown in the example below. If PSE mark is required, the name of the registered importer must be supplied to Cincon on order placement. Product labels will not contain PSE mark if importer name is not supplied. Consult factory or local representative for details".

GENERAL SPECIFICATIONS

Isolation	Input to output = 5,656VDC
Switching Frequency	65KHz typical
Operating Temperature	0-70°C (See Derating Curve)
Storage Temperature	-20-85°C
Cooling	Natural Convection
MTBFMIL-HDBK-217F, GB, at 25°C/115VAC	200Khrs min.
Humidity	93% RH max. Non condensing
Altitude	3000m
Dimensions	3.173 x 1.885 x 1.704 inches (80.60 x 47.90 x 43.30 mm)
Weight	130 g (0.29 Pounds)

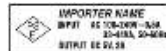

TR18RDM SERIES

18W MEDICAL SWITCHING ADAPTER

Features

- ◆ Universal Input Range 80-264VAC
- ◆ Interchangeable AC Plugs
- ◆ Meets EN60601-1-11and IEC/EN60335
- ◆ Leakage Current < 30uA
- ◆ Continuous Short Circuit Protection
- ◆ Over Voltage Protection
- ◆ Meet IP22
- ◆ Meet CoC Tier 2 & DoE Level VI (Output Cable Length ≤ 1800mm)
- ◆ No Load Power Consumption<75mW



PRELIMINARY



Ordering information

TR18RDMXXX -XX	G	XX
Model No.	DC Plug Type	DC Cable Length and Type
	UL1571	01: 720mm
	WITH OVP	02: 1220mm
		03: 1800mm
		11: 720mm with Ferrite Core
		12: 1220mm with Ferrite Core
		13: 1800mm with Ferrite Core
		* 22AWG / UL1571 or Equivalent for Vo: 9V,12V,15V,18V,24V
		* 18AWG / UL1571 or Equivalent for Vo: 5V

Mechanical Dimensions

All Dimensions are in inches[mm]
Tolerance:Inches:X.XXX±0.02
Millimeters:X.XX±0.5

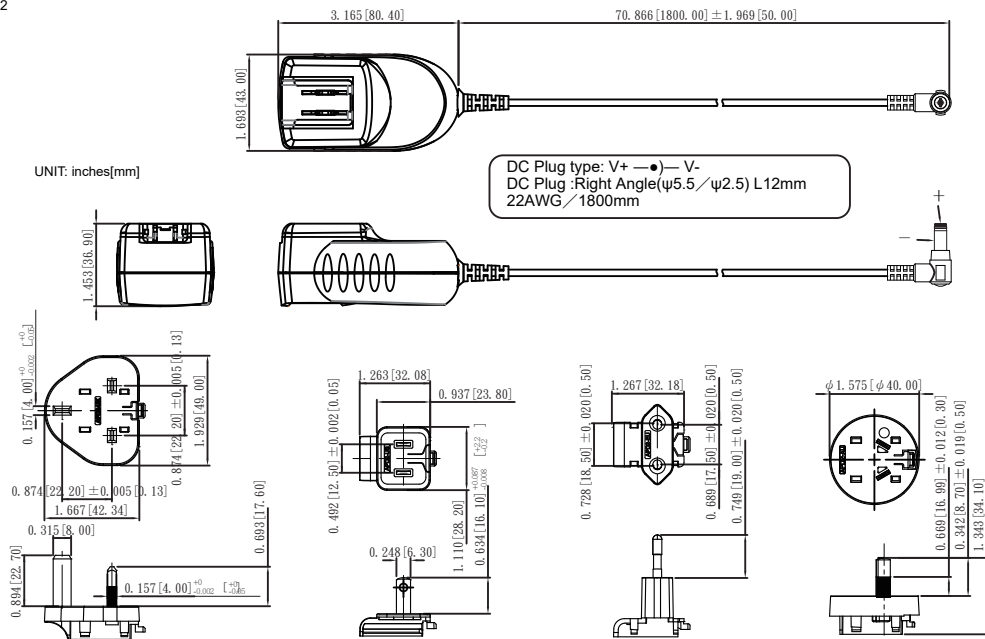

MODEL NUMBER	OUTPUT VOLTAGE	OUTPUT CURRENT	RIPPLE & NOISE (NOTE 1)	VOLTAGE ACCURACY (NOTE 2)	LINE REGULATION (NOTE 3)	LOAD REGULATION (NOTE 4)	% EFF. (Typ.) (NOTE 5)
TR18RDM050	5 V	3 A	100mVp-p	±5%	±1%	±5%	81.84%
TR18RDM090	9 V	2 A	100mVp-p	±3%	±1%	±3%	85.45%
TR18RDM120	12 V	1.5 A	120mVp-p	±3%	±1%	±2%	85.45%
TR18RDM150	15 V	1.2 A	120mVp-p	±3%	±1%	±2%	85.45%
TR18RDM180	18 V	1 A	120mVp-p	±3%	±1%	±2%	85.45%
TR18RDM240	24 V	0.75 A	120mVp-p	±3%	±1%	±2%	85.45%

Derating Curve

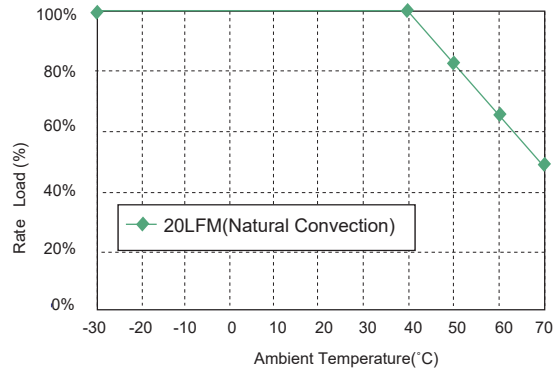

Specifications

All Specifications Typical At Nominal Line, Full Load, and 25°C Unless Otherwise Noted

INPUT SPECIFICATIONS

Voltage	80-264Vac
Frequency	47 to 63Hz
Inrush Current	Cold start @25°C 45A max. @240Vac
Input Current	0.6A max.
Leakage Current	30uA max.

OUTPUT SPECIFICATIONS

Holdup Time	12ms typ. @115Vac
Short Circuit Protection	Hiccup mode(Auto Recovery)
Over Voltage Protection	TVS Component to Clamp

SAFETY AND EMISSION

Emission and Immunity (Ed. 4.0)	EN55011 Class B, EN61000-3-2, EN61000-3-3 EN60601-1-2, IEC61000-4-2,4,5,6,8,11 FCC CFR47 Part 18 Class B
Safety(Ed.3.1)	IEC60601-1:2005+A1:2012 EN 60601-1:2006+A11:2011+A1+A12:2013 ANSI/AAMI ES60601-1:2005/A1:2012 ;

GENERAL SPECIFICATIONS

Isolation	Input to output 4,000VAC
Operating Temperature	-30 -70° C (see derating curve)
Storage Temperature	-30-85° C
Humidity	93% RH max. Non condensing
Cooling	Natural convection
MTBF	MIL-HDBK-217F, GB, 25°C /115VAC TBDmin.
Switching Frequency	65KHz Typical
Altitude	5000m
Dimensions	3.165x1.693x1.453 inches (80.40x43.00x36.90mm)
Weight	T. B. D.

NOTE

1. Add a 0.1uF ceramic capacitor and a 10uF E.L. capacitor to output for Ripple & Noise measuring @20MHz BW.
2. Voltage setpoint at 60% full load.
3. Line regulation is measured from 100Vac to 240Vac full load.
4. Load regulation is measured from 60% to full load and from 60% to 20% load (60% +/- 40% load).
5. Average Efficiency measured at 25%,50%,75%,100% load and input. voltage is 115Vac / 230Vac.

TR30RDM SERIES

30W MEDICAL SWITCHING ADAPTER

Features

- ◆ Universal Input 80-264Vac
- ◆ Interchangeable AC Plugs
- ◆ Approved EN55011, FCC CFR47 Part 18 Class B
- ◆ Meets EN60335-1
- ◆ Approved EN60601-1-11 for Home Healthcare Applications
- ◆ Low Leakage Current <50uA
- ◆ Meets IP22
- ◆ Continuous Short Circuit Protection
- ◆ Over Voltage Protection
- ◆ Meet CoC Tier 2 & DoE Level VI
(Output Cable Length \leq 1800mm)
(TR30RDM050: Output Cable Length \leq 1220mm)
- ◆ No Load Power Consumption <75mW
- ◆ 2MOPP Class II



Ordering information

TR30RDMXXX	-XX	G	XX	-XX-BK
Model No.	DC Plug Type	UL1571 WITH OVP	DC Cable Length and Type	Color of Top Case
		<ul style="list-style-type: none"> * 16AWG / UL1571 or Equivalent for Vo: 5V, 9V * 18AWG / UL1571 or Equivalent for Vo: 12V, 15V * 22AWG / UL1571 or Equivalent for Vo: 18V, 24V 	<ul style="list-style-type: none"> 01: 720mm 02: 1220mm 03: 1800mm 11: 720mm with Ferrite Core 12: 1220mm with Ferrite Core 13: 1800mm with Ferrite Core 	<ul style="list-style-type: none"> BK-BK : Black-Black BE-BK : Blue-Black RD-BK : Red-Black

Mechanical Dimensions

All Dimensions are in inches[mm]
Tolerance: Inches: X.XXX \pm 0.02
Millimeters: X.XX \pm 0.5

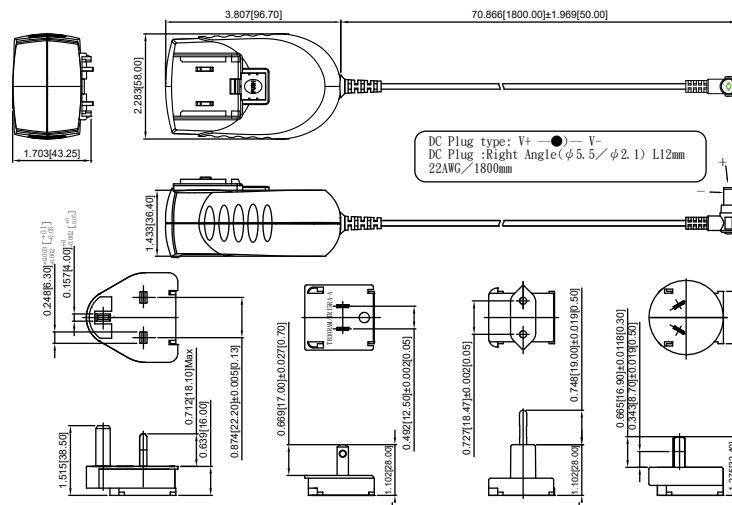

DC Plug type: V+ \bullet V- \ominus
DC Plug : Right Angle(ϕ 5.5/ ϕ 2.1) L12mm
22AWG/1800mm

MODEL NUMBER	OUTPUT VOLTAGE	OUTPUT CURRENT	RIPPLE & NOISE (NOTE 1)	VOLTAGE ACCURACY (NOTE 2)	LINE REGULATION (NOTE 3)	LOAD REGULATION (NOTE 4)	% EFF. (Typ.) (NOTE 5)
TR30RDM050	5 V	5.0 A	100mVp-p	\pm 2%	\pm 1%	\pm 6%	84%
TR30RDM090	9 V	3.3 A	100mVp-p	\pm 2%	\pm 1%	\pm 3%	88%
TR30RDM120	12 V	2.5 A	120mVp-p	\pm 2%	\pm 1%	\pm 2%	88%
TR30RDM150	15 V	2.0 A	120mVp-p	\pm 2%	\pm 1%	\pm 2%	88%
TR30RDM180	18 V	1.67 A	120mVp-p	\pm 2%	\pm 1%	\pm 2%	88%
TR30RDM240	24 V	1.25 A	120mVp-p	\pm 2%	\pm 1%	\pm 2%	88%

Derating Curve

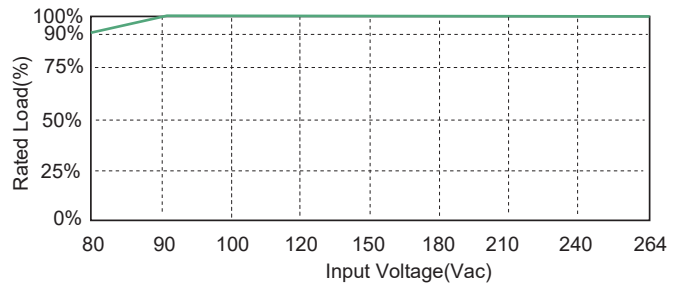
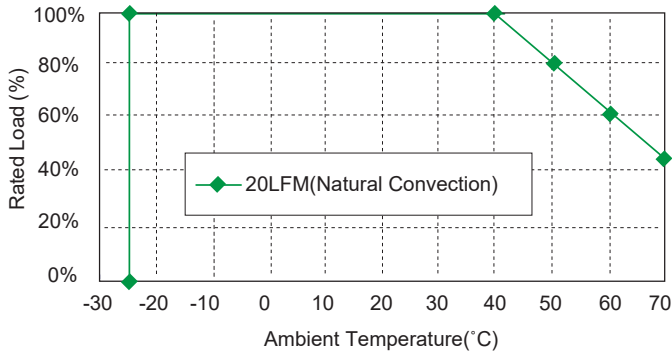

Specifications

All Specifications Typical At Nominal Line, Full Load, and 25°C Unless Otherwise Noted

INPUT SPECIFICATIONS

Voltage	80-264Vac (see derating curve)
Frequency	47 to 63Hz
Inrush Current	Cold start @25°C 85A max. @240Vac
Input Current	0.8A max.
Leakage Current	50uA max

OUTPUT SPECIFICATIONS

Holdup Time	10ms typ. @115Vac
Short Circuit Protection	Hiccup Mode Continuous(Auto Recovery)
Over Voltage Protection	Latch

SAFETY AND EMISSION

Emission and Immunity (Ed. 4.0)	EN55011, EN60601-1-2 IEN61000-3-2, EN61000-3-3, IEC61000-4-2, 3, 4, 5, 6, 8, 11 FCC CFR47 Part 18 Class B
Safety (Ed. 3.1)	IEC60601-1:2005+A1, EN60601-1-11 EN60601-1:2006+A11:2011+A1+A12 ANSI/AAMI ES60601-1:2005/A1:2012

GENERAL SPECIFICATIONS

Isolation	Input to output = 4000VAC
Operating Temperature	-25 -70°C(see derating curve)
Storage Temperature	-25 -85°C
Humidity	93% RH max. Non condensing
Cooling	Natural Convection
Switching Frequency	65KHz Typical
MTBF	MIL-HDBK-217F, GB, 25°C/115VAC 380Khrs min
Life time	26280 hours min.@ 75% load, 40°C
Altitude	5000m
Dimensions	3.807x2.283x1.703 inches (96.70x58.00x43.25mm)
Weight	200g(0.44 Pounds)

NOTE

1. Add a 0.1uF ceramic capacitor and a 10uF E.L. capacitor to output for ripple & noise measuring @20MHz BW.
2. Voltage setpoint at 60% full load.
3. Line regulation is measured from 100Vac to 240Vac full load.
4. Load regulation is measured from 60% to full load and from 60% to 20% load (60% +/- 40% load).
5. Efficiency measured at 75% load and input voltage is 230Vac.

TR30RAM SERIES

30 WATT, MEDICAL SWITCHING ADAPTER

Features

- ◆ Universal Input Range 90-264VAC
- ◆ Continuous Short Circuit Protection
- ◆ Over Voltage Protection
- ◆ Meets EN60601-1 and EN55011 Class B
- ◆ Meets 2 MOPP
- ◆ Efficiency & Standby Power Meet Level V (Output Cable Length \leq 1800mm)
- ◆ Provide PSE Mark



Ordering information

TR30RAMXXX - XX DC Plug Type E XX DC Cable Length and Type - XX Color of Overmold Case -BK
 Model No. DC Plug Type E XX DC Cable Length and Type - XX Color of Overmold Case -BK
 01: 720mm
 02: 1220mm
 03: 1800mm
 11: 720mm with Ferrite Core
 12: 1220mm with Ferrite Core
 13: 1800mm with Ferrite Core
 * 18AWG / UL1185
 * 16AWG / UL1185 for 5V, 9V

Mechanical Dimensions

All Dimensions are in Inches (mm)
 Tolerance Inches: X.XXX±0.02
 Millimeters: X.XX±0.5

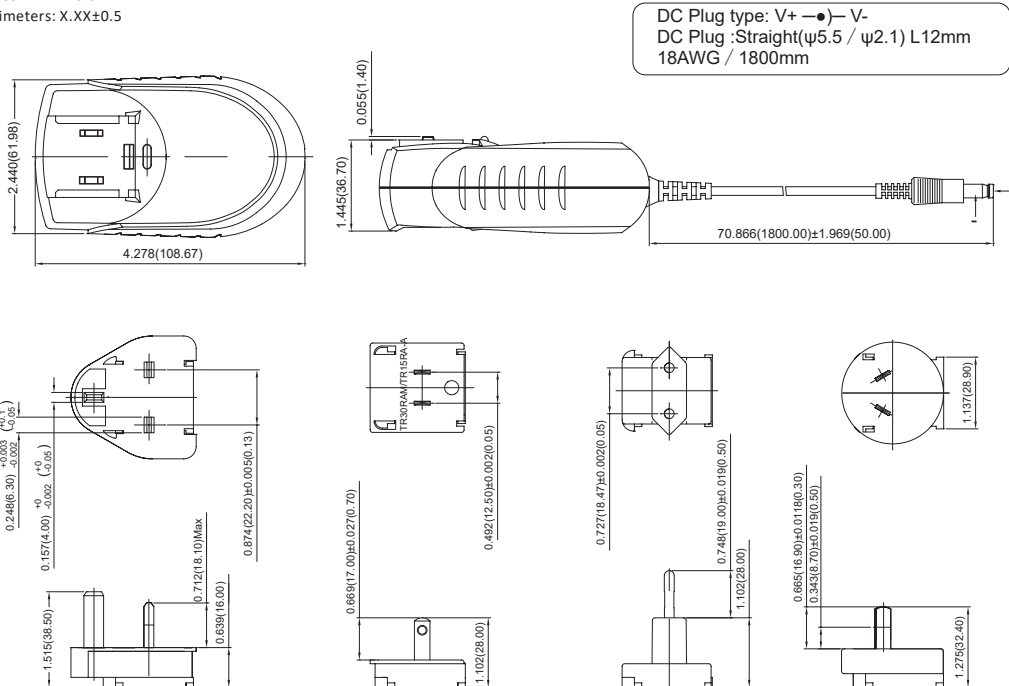

MODEL NUMBER	OUTPUT VOLTAGE	OUTPUT CURRENT	RIPPLE & NOISE (NOTE 1)	VOLTAGE ACCURACY (NOTE 2)	LINE REGULATION (NOTE 3)	LOAD REGULATION (NOTE 4)	% EFF. (Typ.) (NOTE 5)
TR30RAM050	5 V	4.0 A	1%	±2%	±1%	±6%	80%
TR30RAM090	9 V	3.0 A	1%	±2%	±1%	±3%	84%
TR30RAM120	12 V	2.5 A	1%	±2%	±1%	±2%	84%
TR30RAM150	15 V	2.0 A	1%	±2%	±1%	±2%	85%
TR30RAM180	18 V	1.67 A	1%	±2%	±1%	±2%	85%
TR30RAM240	24 V	1.25 A	1%	±2%	±1%	±2%	86%

Derating Curve

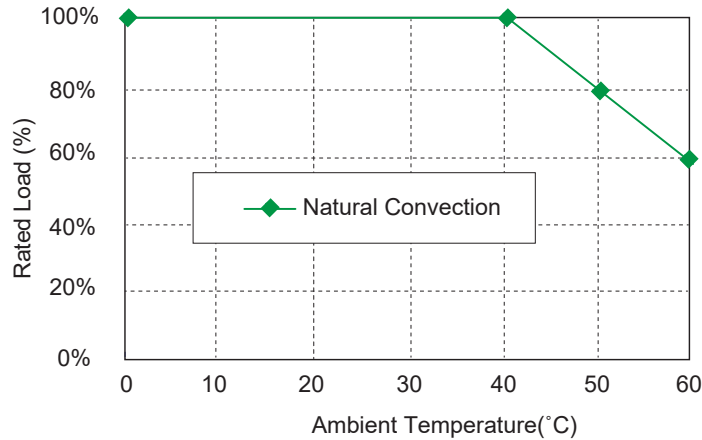

Specifications

All Specifications Typical At Nominal Line, 75% Load, and 25°C Unless Otherwise Noted

INPUT SPECIFICATIONS

Voltage	90-264Vac, 120-370Vdc
Frequency	47 to 63Hz
Input Current	100Vac/0.8A max., 240Vac/0.4A max.
Inrush Current	Cold start@25°C 100A max. @240Vac
Leakage Current	100µA max.

SAFETY AND EMISSION

Emission and Immunity (Ed. 4.0)

Safety(Ed. 3.1)

EN55011 Class B, FCC CFR47
Part 18 Class B
EN60601-1-2, EN61000-3-2-3,
EN61000-4-2, 3, 4, 5, 6, 8, 11
IEC60601-1:2005+A1:2012
EN60601-1:2006+A11:2011+A1 UL+A12,
ANSI/AAMI ES60601-1:2005
IEC 60950-1, EN60950-1,
UL60950-1

OUTPUT SPECIFICATIONS

Hold-up Time	10ms typ. @115Vac
Short Circuit Protection	Hiccup Mode (Auto Recovery)
Over Voltage Protection	TVS Component to Clamp
Temperature Coefficient	±0.05%/°C

NOTE

1. Voltage accuracy is set at 60% load and 25°C Ta.
2. Add a 0.1µF ceramic capacitor and a 10µF E.L. capacitor to output for ripple & noise measuring @20MHz BW.
3. Line regulation measured from 100VAC to 240VAC with full load.
4. Load regulation measured from 60% to full load and from 60% to 20% load (60% +/- 40% load)
5. Typical efficiency with 230VAC and max. load at 25°C.

GENERAL SPECIFICATIONS

Isolation	Input to output = 4,000VAC (5,656VDC)
Operating Temperature	0-60°C (See Derating Curve)
Storage Temperature	-20-85°C
Humidity	93% RH max. Non condensing
Cooling	Natural Convection
Switching Frequency	70KHz Typical
MTBF MIL-HDBK-217F, GB, 25°C/115VAC	200Khrs min.
Altitude	3000m
Dimensions	4.278 x 2.440 x 1.445 inches (108.67 x 61.98 x 36.70 mm)
Weight	300 g (0.67 Pounds)

TR36M SERIES

36W MEDICAL SWITCHING ADAPTER

Features

- ◆ Universal Input Range 80-264VAC
- ◆ Approved EN55011, FCC CFR47 Part15 Class B
- ◆ Meets EN60335
- ◆ Approved EN60601-1-11 for Home Healthcare Applications
- ◆ Low Leakage Current < 80uA
- ◆ Continuous Short Circuit Protection
- ◆ Over Voltage Protection
- ◆ Meet CoC Tier 2 & DoE Level VI
- ◆ (Output Cable Length \leq 1800mm)
- ◆ (TR36M050: Output Cable Length \leq 1220mm)
- ◆ No Load Power Consumption < 75mW
- ◆ 2 MOPP Class II



Ordering information

TR36MXXX	-XX	G	XX
Model No.	DC Plug Type	G: UL1571 WITH OVP E: UL1185 WITH OVP * 16AWG / UL1571 or Equivalent for Vo: 5V * 18AWG / UL1571 or Equivalent for Vo: 9V,12V, 13.5V * 20AWG / UL1571 or Equivalent for Vo: 15V, 18V,24V * 20AWG / UL1185 or Equivalent for Vo: 36V, 48V	DC Cable Length and Typ 01: 720mm 02: 1220mm 03: 1800mm 11: 720mm with Ferrite Core 12: 1220mm with Ferrite Core 13: 1800mm with Ferrite Core

Mechanical Dimensions

All Dimensions are in inches[mm]
 Tolerance:Inches:X.XXX±0.02
 Millimeters:X.XX±0.5

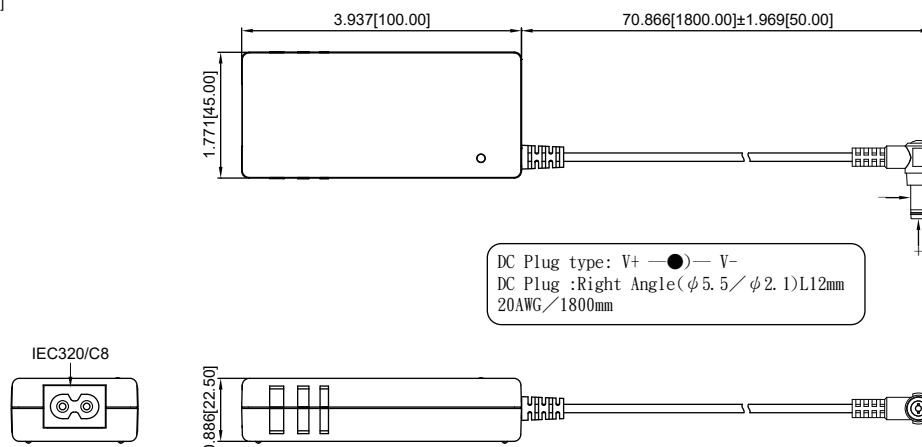

MODEL NUMBER	OUTPUT VOLTAGE	OUTPUT CURRENT	RIPPLE & NOISE (NOTE 1)	VOLTAGE ACCURACY (NOTE 2)	LINE REGULATION (NOTE 3)	LOAD REGULATION (NOTE 4)	% EFF. (Typ.) (NOTE 5)
TR36M050	5 V	5.0 A	100mVp-p	±2%	±1%	±6%	85%
TR36M090	9 V	3.3 A	120mVp-p	±2%	±1%	±4%	88%
TR36M120	12 V	2.5 A	120mVp-p	±2%	±1%	±2%	89%
TR36M135	13.5 V	2.4 A	130mVp-p	±2%	±1%	±2%	89%
TR36M150	15 V	2.4 A	150mVp-p	±2%	±1%	±2%	89%
TR36M180	18 V	2.0 A	180mVp-p	±2%	±1%	±2%	89%
TR36M240	24 V	1.5 A	240mVp-p	±2%	±1%	±2%	89%
TR36M360	36 V	1.0 A	360mVp-p	±2%	±1%	±2%	89%
TR36M480	48 V	0.75 A	480mVp-p	±2%	±1%	±2%	89%

Derating Curve

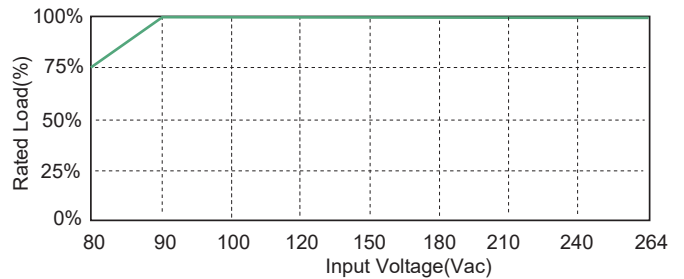
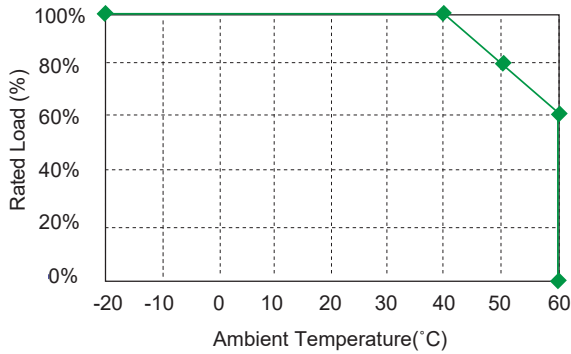

Specifications

All Specifications Typical At Nominal Line, Full Load, and 25°C Unless Otherwise Noted

INPUT SPECIFICATIONS

Voltage	80-264Vac (see derating curve)
Frequency	47 to 63Hz
Inrush Current	Cold start @25°C 100A max. @240Vac
Input Current	0.9A max.
Leakage Current	80uA max

OUTPUT SPECIFICATIONS

Holdup Time	10ms typ. @115Vac
Short Circuit Protection	Hiccup Mode Continuous(Auto Recovery)
Over Voltage Protection	IC Component to Clamp(Auto Recovery)
Temperature Coefficient	±0.05%/°C

SAFETY AND EMISSION

Emission and Immunity (Ed. 4.0)	EN55011, EN60601-1-2 IEN61000-3-2, EN61000-3-3, IEC61000-4-2, 3, 4, 5, 6, 8, 11 FCC CFR47 Part 15 Class B
Safety Approved (Ed.3.1)	IEC60601-1:2005+A1,EN60601-1-11 EN60601-1:2006+A11:2011+A1+A12 ANSI/AAMI ES60601-1:2005/A1:2012

GENERAL SPECIFICATIONS

Isolation	Input to output = 4000VAC
Operating Temperature	-30 - 60°C(see derating curve)
Storage Temperature	-30 - 85°C
Humidity	93% RH max. Non condensing
Cooling	Natural Convection
Switching Frequency	65KHz Typical
MTBF	MIL-HDBK-217F, GB, 25°C/115VAC 1000Khrs max
Altitude	5000m
Dimensions:	3.937x1.771x0.886 inches (100.00x45.00x22.50mm)
Weight	150g(0.33 Pounds)

NOTE

1. Add a 0.1uF ceramic capacitor and a 10uF E.L. capacitor to output for ripple & noise measuring @20MHz BW.
2. Voltage setpoint at 60% full load.
3. Line regulation is measured from 100Vac to 240Vac full load.
4. Load regulation is measured from 60% to full load and from 60% to 20% load (60% +/- 40% load).
5. Efficiency measured at 75% load and input voltage is 230Vac.

TR60M SERIES

60 WATT, MEDICAL SWITCHING ADAPTER

Features

- ◆ Universal Input Range 90-264VAC
- ◆ Meets EN60601-1 and EN55011 Class B
- ◆ Continuous Short Circuit Protection
- ◆ Over Voltage Protection
- ◆ Meets 2 MOPP
- ◆ Meets CEC Level IV
(Output Cable Length \leq 1800mm)
(TR60M Series Meets CEC IV Except TR60M05 is Non-CEC Compliant)
(TR60M12: Output Cable Length \leq 1220mm 16AWG)
- ◆ Efficiency & Standby Power Meet Level V (Option)
(Output Cable Length \leq 1800mm)
(TR60M12: Output Cable Length \leq 720mm 16AWG)
(TR60M15: Output Cable Length \leq 1220mm 16AWG)
(TR60M18, TR60M19: Output Cable Length \leq 1500mm)



Ordering information

TR60MX- Model No.	XX DC Plug Type	X OVP E: With OVP	XX DC Cable Length and Type 01: 720mm 02: 1220mm 03: 1800mm 11: 720mm with Ferrite Core 12: 1220mm with Ferrite Core 13: 1800mm with Ferrite Core *18AWG/UL1185
----------------------	--------------------	-------------------------	---

Mechanical Dimensions

All Dimensions are in Inches (mm)
Tolerance Inches: X.XXX \pm 0.02
Millimeters: X.XX \pm 0.5

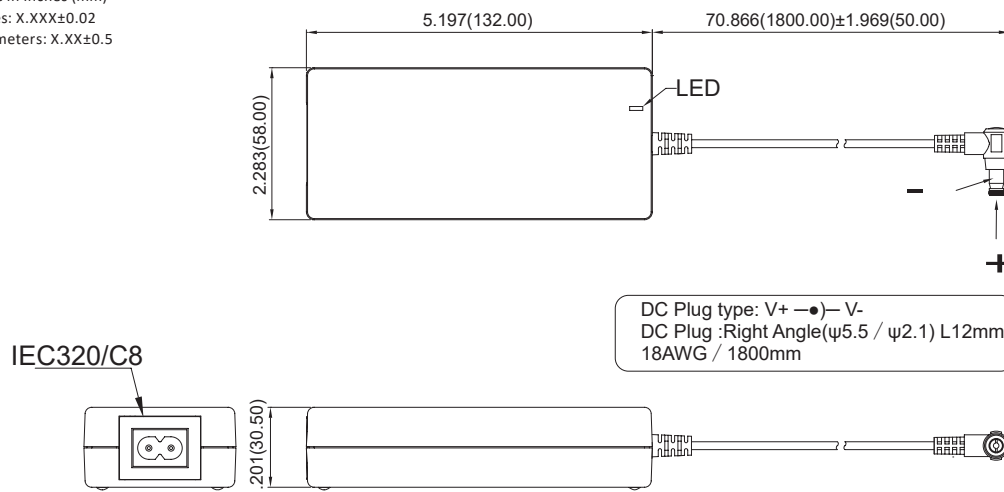

MODEL NUMBER	OUTPUT VOLTAGE	OUTPUT CURRENT	RIPPLE & NOISE (NOTE 2)	VOLTAGE ACCURACY (NOTE 1)	LINE REGULATION (NOTE 3)	LOAD REGULATION (NOTE 4)	% EFF. (Typ.) (NOTE 5)
TR60M05	5 V	6 A	50 mV	\pm 4%	\pm 1%	\pm 6%	75%
TR60M12	12 V	5 A	120 mV	\pm 2%	\pm 1%	\pm 5%	85%
TR60M15	15 V	4 A	150 mV	\pm 2%	\pm 1%	\pm 3%	85%
TR60M18	18 V	3.33 A	180 mV	\pm 2%	\pm 1%	\pm 2%	86%
TR60M19	19 V	3.15 A	190 mV	\pm 2%	\pm 1%	\pm 2%	86%
TR60M24	24 V	2.5 A	240 mV	\pm 2%	\pm 1%	\pm 2%	87%
TR60M36	36 V	1.66 A	360 mV	\pm 2%	\pm 1%	\pm 2%	87%
TR60M48	48 V	1.25 A	480 mV	\pm 2%	\pm 1%	\pm 2%	87%

Derating Curve

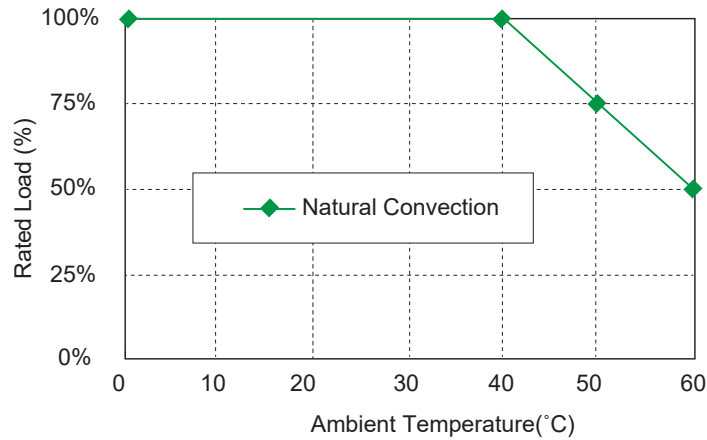

Specifications

All Specifications Typical At Nominal Line, Full Load, and 25°C Unless Otherwise Noted

INPUT SPECIFICATIONS

Voltage	90-264Vac, 120-370Vdc
Frequency	47 to 63Hz
Inrush Current	Cold Start @25°C 80A max. @240Vac
Conducted EMI	CISPR/FCC Class B
Leakage Current	0.1mA max.

SAFETY AND EMISSION

Emission and Immunity (Ed. 4.0)	EN55011, EN60601-1-2, EN61000-3-2, EN61000-3-3 Class II, IEC60601-1:2005+A1:2012, EN60601-1:2006/A1:2013, UL ANSI/AAMI ES60601-1:2005
Safety(Ed. 3.1)	

OUTPUT SPECIFICATIONS

Hold-up Time	8ms typ. @115Vac
Short Circuit Protection	Continuous
Over Voltage Protection	Yes
Temperature Coefficient	±0.05%/°C

NOTE

1. Voltage accuracy at 60% full load.
2. Add a 0.1µF ceramic capacitor and a 10µF E.L. capacitor to output for Ripple & Noise measurement @20MHz BW.
3. Line regulation is measured from 100VAC to 240VAC full load.
4. Load regulation is measured from 60% to 100% full load and from 60%to 20% full load (60% +/- 40% full load).
5. Typical efficiency at 230VAC and full load at 25°C.

GENERAL SPECIFICATIONS

Isolation	Input to output = 4,000VAC
Operating Temperature	0-60°C (See Derating Curve)
Storage Temperature	-20-85°C
Humidity	93% RH max. Non condensing
Cooling	Natural Convection
Switching Frequency	100KHz Typical
MTBFMIL-HDBK-217F, GB, at 25°C/115VAC	200Khrs min.
Altitude	3000m
Dimensions	5.197 x 2.283 x 1.201 inches (132.00 x 58.00 x 30.50 mm)
Weight	345 g (0.76 Pounds)

TR70M SERIES

70W MEDICAL SWITCHING ADAPTER

Features

- ◆ Universal Input Range 80-264VAC
- ◆ Meets EN55011 Class B and CISPR/FCC Class B
- ◆ Continuous Short Circuit Protection
- ◆ Over Voltage Protection
- ◆ No Load Power Consumption <150mW
- ◆ Meets CoC Tier 2 & DoE Level VI
- ◆ Meets IEC/EN60335-1
- ◆ Meets 2 MOPP
- ◆ Class I (TR70MA) & Class II (TR70MB)
- ◆ Altitude 5000m

(TR70MA120&TR70MB120: Output Cable Length ≤ 1220mm 16AWG) (note7)
 (TR70MA150&TR70MB150: Output Cable Length ≤ 1220mm 16AWG)
 (TR70MA180&TR70MB180: Output Cable Length ≤ 1800mm 16AWG)
 (Output Cable Length ≤ 1800mm 18AWG)



Ordering information

TR70MXXXX	XX	X	XX
Model No.	DC Plug Type	OVP	DC Cable Length and Type
X: A or B		E: With OV	01: 720mm
A: CLASS I			02: 1220mm
B: CLASS II			03: 1800mm
			11: 720mm with Ferrite Core
			12: 1220mm with Ferrite Core
			13: 1800mm with Ferrite Core
			*18AWG/UL1185
			*16AWG/UL1185 for 12V

Mechanical Dimensions

All Dimensions are in inches(mm)
 Tolerance: Inches: X.XXX±0.02
 Millimeters: XX±0.5
 UNIT: inches[mm]

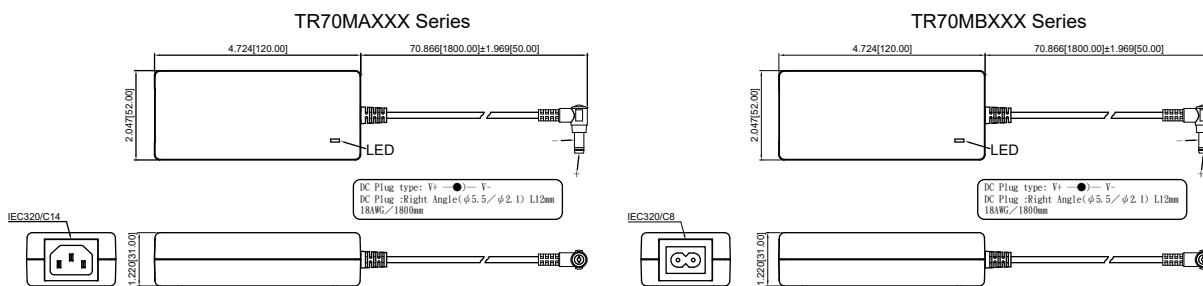

MODEL NUMBER	OUTPUT VOLTAGE	OUTPUT CURRENT	RIPPLE & NOISE (NOTE 2)	VOLTAGE ACCURACY (NOTE 1)	LINE REGULATION (NOTE 3)	LOAD REGULATION (NOTE 4)	% EFF. (Typ.) (NOTE 5)
TR70MA120	12 V	5.8 A	120mVp-p	±2%	±1%	±5%	89%
TR70MA150	15 V	4.65 A	150mVp-p	±2%	±1%	±3%	89%
TR70MA180	18 V	3.9 A	180mVp-p	±2%	±1%	±2%	89%
TR70MA240	24 V	3.0 A	240mVp-p	±2%	±1%	±2%	90%
TR70MA360	36 V	1.9 A	360mVp-p	±2%	±1%	±2%	90%
TR70MA480	48 V	1.5 A	480mVp-p	±2%	±1%	±2%	91%
TR70MB120	12 V	5.8 A	120mVp-p	±2%	±1%	±5%	89%
TR70MB150	15 V	4.65 A	150mVp-p	±2%	±1%	±3%	89%
TR70MB180	18 V	3.9 A	180mVp-p	±2%	±1%	±2%	89%
TR70MB240	24 V	3.0 A	240mVp-p	±2%	±1%	±2%	90%
TR70MB360	36 V	1.9 A	360mVp-p	±2%	±1%	±2%	90%
TR70MB480	48 V	1.5 A	480mVp-p	±2%	±1%	±2%	91%

Derating Curve

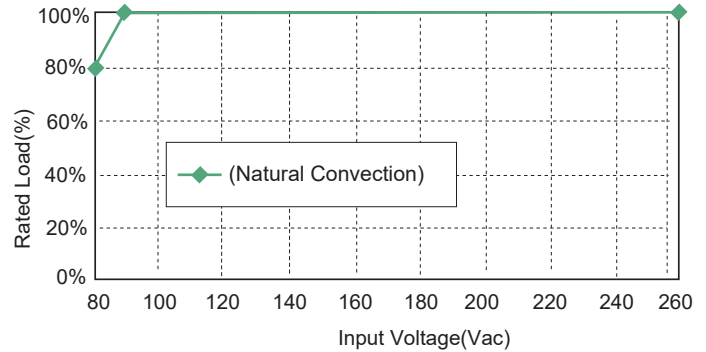
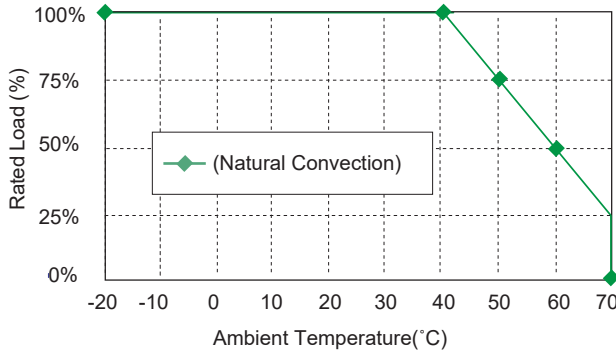

Specifications

All Specifications Typical At Nominal Line, Full Load, and 25°C Unless Otherwise Noted

INPUT SPECIFICATIONS

Voltage	80-264Vac(80Vac with derating curve)
Frequency	47 to 63Hz
Inrush Current	Cold start @25°C100A max. @240Vac
Conducted EMI	CISPR/FCC Class B
Leakage Current	90uA max.

OUTPUT SPECIFICATIONS

Holdup Time	10ms typ. @115Vac
Short Circuit Protection	Hiccup Mode (Auto Recovery)
Over Voltage Protection	IC Component to Clamp(Auto Recovery)
Temperature Coefficient	±0.05%/°C max

SAFETY AND EMISSION

Emission and Immunity (Ed. 4.0)	EN55011 Class B, EN61000-3-2,3 EN60601-1-2, IEC 61000-4-2, 3, 4, 5, 6, 8, 11
Safety Approved (Ed.3.1)	CLASS I and CLASS II, IEC60601-1 EN 60601-1 UL ANSI/AAMI ES60601-1

GENERAL SPECIFICATIONS

Isolation	Input to output = 4,500VAC
Operating Temperature	-20 - 70°C (See Derating Curve, note6)
Storage Temperature	-40-85 °C
Humidity	93% RH max. Non condensing
Cooling	Natural Convection
Switching Frequency	65KHz Typical
MTBF	MIL-HDBK-217F, GB, at 25°C/115VAC 500Khrs min.
Altitude	5000m
Life time	26000 hours min. @75% 40degC
AC Inlet	IEC320/C14(TR70MA) IEC320/C8(TR70MB)
Dimensions	4.724x2.047x1.220 inches (120.00x52.00x31.00 mm)
Weight	300g(0.66 Pounds)

NOTE

1. Voltage accuracy at 60% full load.
2. Add a 0.1uF ceramic capacitor and a 10uF E.L. capacitor to output for ripple & noise measurement @20MHz BW.
3. Line regulation is measured from 100Vac to 240Vac, full load.
4. Load regulation is measured from 60% to 100% full load and from 60% to 20% full load (60% +/- 40% full load).
5. Typical efficiency at 230VAC and 75% load at 25°C.
6. -30°C can be start-up at full load.
7. TR70MA120 & TR70MB120 of 115VAC full load meet DoE Level VI and 230VAC full load meet CoC Tier 2.

TR100M SERIES

100 WATT, MEDICAL SWITCHING ADAPTER

Features

- ◆ Universal Input Range 90-264VAC
- ◆ Meets EN60601-1 and EN55011 Class B
- ◆ Continuous Short Circuit Protection
- ◆ Over Voltage Protection
- ◆ Efficiency & Standby Power Meet Level V
(TR100M120-150: Output Cable Length \leq 1500mm 14AWG /UL1185)
(TR100M180-480: Output Cable Length \leq 1800mm 16AWG /UL1185)
- ◆ Meets 2 MOPP



Ordering information

TR100MXXX- Model No.	XX DC Plug Type	X OVP E: with OVP	XX or XXX DC Cable Length and Type 11: 720mm with Ferrite Core 12: 1220mm with Ferrite Core 36: 1500mm with Ferrite Core 13: 1800mm with Ferrite Core
-------------------------	--------------------	-------------------------	--

Mechanical Dimensions

All Dimensions are in Inches (mm)
Tolerance Inches: X.XXX \pm 0.02
Millimeters: X.XX \pm 0.5
UNIT: inches(mm)

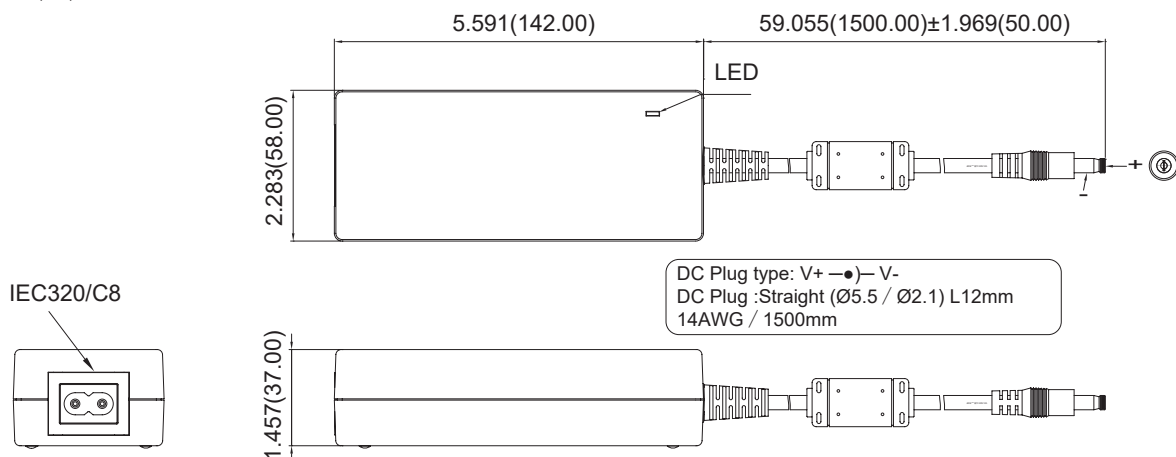

MODEL NUMBER	OUTPUT VOLTAGE	OUTPUT CURRENT	RIPPLE & NOISE (NOTE 2)	VOLTAGE ACCURACY (NOTE 1)	LINE REGULATION (NOTE 3)	LOAD REGULATION (NOTE 4)	% EFF. (Typ.) (NOTE 5)
TR100M120	12 V	8.34 A	1%	\pm 2%	\pm 1%	\pm 4%	88%
TR100M150	15 V	6.67 A	1%	\pm 2%	\pm 1%	\pm 3%	88%
TR100M180	18 V	5.56 A	1%	\pm 2%	\pm 1%	\pm 2%	88%
TR100M190	19 V	5.27 A	1%	\pm 2%	\pm 1%	\pm 2%	88%
TR100M200	20 V	5.0 A	1%	\pm 2%	\pm 1%	\pm 2%	88%
TR100M240	24 V	4.17 A	1%	\pm 2%	\pm 1%	\pm 2%	89%
TR100M480	48 V	2.1 A	1%	\pm 2%	\pm 1%	\pm 2%	89%

Derating Curve

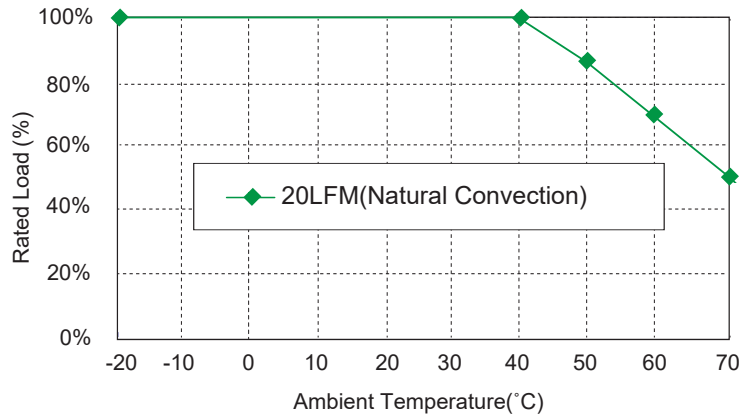

Specifications

All Specifications Typical At Nominal Line, Full Load, and 25°C Unless Otherwise Noted

INPUT SPECIFICATIONS

Voltage	90-264Vac, 120-370Vdc
Frequency	47 to 63Hz
Inrush Current	Cold Start @25°C 100A max. @240Vac
Conducted EMI	CISPR/FCC Class B
Isolation	Input to output = 4,000 Vac
Leakage Current	100uA max.

SAFETY AND EMISSION

Emission and Immunity (Ed. 4.0)	EN55011, FCC CRF47 Part 18 EN60601-1-2, EN61000-3-2, 3, IEC61000-4-2, 3, 4, 5, 6, 8, 11 IEC60601-1:2005+A1:2012, EN60601-1:2006/A1:2013 UL ANSI/AAMI ES60601-1:2005
Safety(Ed. 3.1)	

OUTPUT SPECIFICATIONS

Hold-up Time	16ms typ. @115Vac
Short Circuit Protection	Hiccup Mode (Auto Recover)
Over Voltage Protection	TVS Component to Clamp
Temperature Coefficient	±0.05%/°C

NOTE

1. Voltage accuracy at 60% full load.
2. Add a 0.1μF ceramic capacitor and a 10μF E.L. capacitor to output for ripple & noise measurement @20MHz BW.
3. Line regulation is measured from 100Vac to 240Vac, full load.
4. Load regulation is measured from 60% to 100% full load and from 60% to 20% full load (60% +/- 40% full load).
5. Typical efficiency with 230 VAC and full load at 25°C

GENERAL SPECIFICATIONS

Operating Temperature	-20-70°C (See Derating Curve)
Storage Temperature	-20-85°C
Humidity	93% RH max. Non condensing
Cooling	Natural Convection
Switching Frequency	70KHz Typical
MTBF ... MIL-HDBK-217F, GB, at 25°C/115VAC	150Khrs min.
Altitude	3000m
Dimensions	5.591 x 2.283 x 1.457 inches (142.00 x 58.00 x 37.00 mm)
Weight	500 g
AC Inlet	IEC320/C8

TR160M SERIES

160W SWITCHING ADAPTER

Features

- ◆ Compact Size
- ◆ Universal Input Range 80-264VAC
- ◆ Approved IEC/EN/UL 60601-1
- ◆ Meets EN55011 Class B & CISPR/FCC Class B
- ◆ Meets IEC/EN60335-1
- ◆ Continuous Short Circuit Protection
- ◆ Over Voltage Protection
- ◆ No Load Power Consumption<150mW
- ◆ Meets 2 MOPP
- ◆ Class I (TR160MA) & Class II (TR160MB)
- ◆ CoC Tier 2 & DoE Level VI
(TR160M120:Output Cable Length \leq 950mm)
(TR160M240~480:Output Cable Length \leq 1220mm)

PRELIMINARY



VI

Ordering information

TR160MXXXX	-XX	X	XX
Model No.	DC Plug Type	OVP	DC Cable Length and Type
X: A or B		E: With OV	471:950mm with Ferrite Core
A:CLASS I			12:1220mm with Ferrite Core
B:CLASS II			
*UL2464 Cable For all models			

Mechanical Dimensions

All Dimensions are in inches[mm]
Tolerance:Inches:X.XXX \pm 0.02
Millimeters:X.XX \pm 0.5

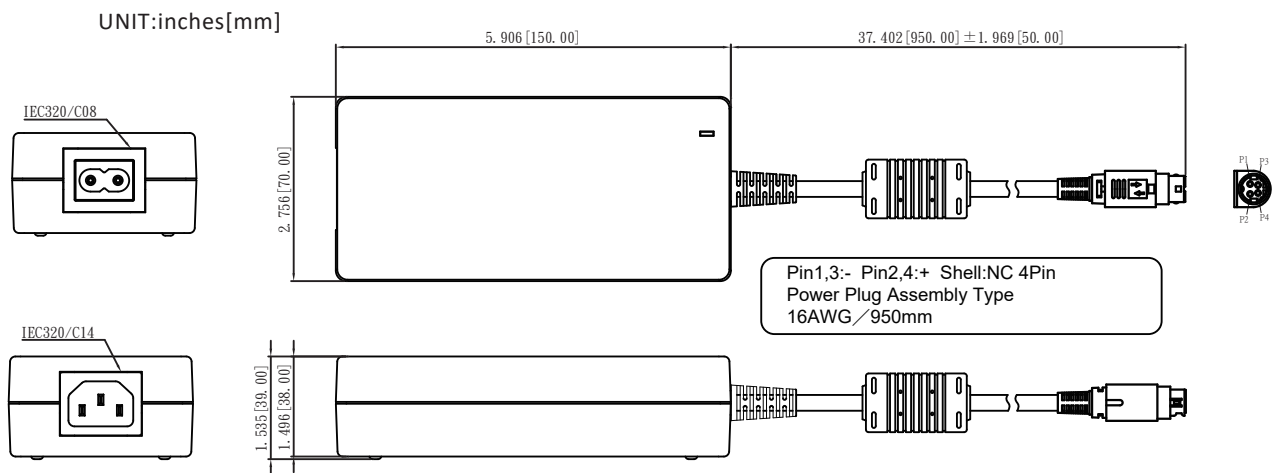

MODEL NUMBER	OUTPUT VOLTAGE	OUTPUT CURRENT	RIPPLE & NOISE (NOTE 1)	VOLTAGE ACCURACY (NOTE 2)	LINE REGULATION (NOTE 3)	LOAD REGULATION (NOTE 4)	% EFF. (Typ.) (NOTE 5)
TR160MA120	12 V	12.5 A	1%	\pm 2.5%	\pm 1%	\pm 4%	91%
TR160MA240	24 V	6.66 A	1%	\pm 2.5%	\pm 1%	\pm 4%	92%
TR160MA360	36 V	4.44 A	1%	\pm 2.5%	\pm 1%	\pm 4%	92%
TR160MA480	48 V	3.33 A	1%	\pm 2.5%	\pm 1%	\pm 4%	93%
TR160MB120	12 V	12.5 A	1%	\pm 2.5%	\pm 1%	\pm 4%	91%
TR160MB240	24 V	6.66 A	1%	\pm 2.5%	\pm 1%	\pm 4%	92%
TR160MB360	36 V	4.44 A	1%	\pm 2.5%	\pm 1%	\pm 4%	92%
TR160MB480	48 V	3.33 A	1%	\pm 2.5%	\pm 1%	\pm 4%	93%

Derating Curve

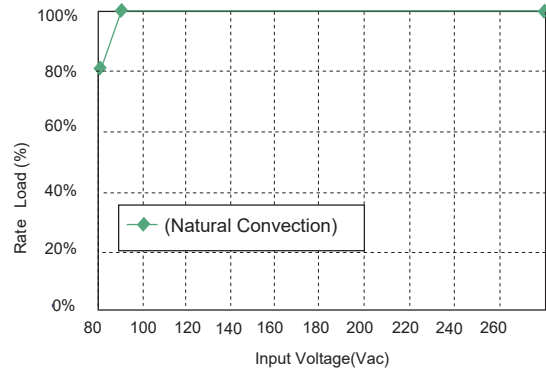
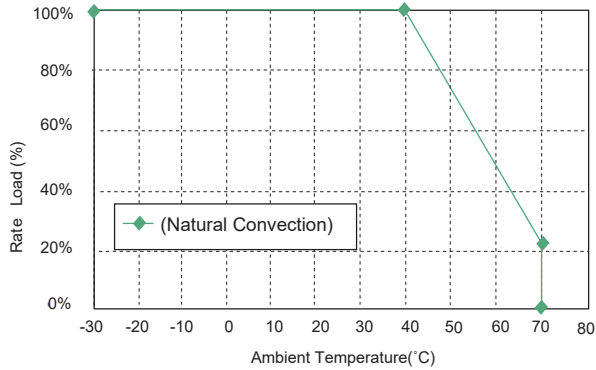

Specifications

All Specifications Typical At Nominal Line, Full Load, and 25°C Unless Otherwise Noted

INPUT SPECIFICATIONS

Voltage	80-264Vac
Frequency	47 to 63Hz
Inrush Current	120A max. @240Vac
Input Current	100Vac/2.0A max 240Vac/1.0A max
Leakage Current	0.1mA max.
Conducted EMI	CISPR/FCC Class B

OUTPUT SPECIFICATIONS

Hold up Time	16ms typ. @115Vac
Short Circuit Protection	Hiccup mode(Auto Recovery)
Over Voltage Protection	latch
Temperature Coefficient	±0.05%/71° C

SAFETY AND EMISSION

Emission and Immunity (Ed. 4.0)	EN55011 Class B, EN61000-3-2,3 EN60601-1-2, IEC 61000-4-2, 3, 4, 5, 6, 8, 11
Safety Approved (Ed.3.1)	IEC60601-1, EN 60601-1 UL ANSI/AAMI ES60601-1

GENERAL SPECIFICATIONS

Isolation	-Input to output 4,000VAC
Operating Temperature	-20 ~ 70°C(see derating curve) -30°C can be start-up -40 -85 °C
Storage Temperature	-40 -85 °C
Humidity	93% RH max. Non condensing
Cooling	Natural convection
MTBF	MIL-HDBK-217F, GB, 25°C/115VAC T.B.D
Switching Frequency	110KHz typ.
Altitude	5000m
Life time	26000 hours min. @75% 40degC
Dimensions	5.906x2.756x1.497 inches (150x70x38mm)
Weight	540g

NOTE

1. Add a 0.1uF ceramic capacitor and a 10uF E.L. capacitor to output for Ripple & Noise measuring @20MHz BW.
2. Voltage setpoint at 60% full load.
3. Line regulation measured from 100Vac to 240Vac, full load.
4. Load regulation measured from 60% to 100% full load and from 60% to 20% load (60% +/- 40% full load)
5. Typical efficiency at 230VAC and 75% load at 25° C.

EC4AW-H6 SERIES

5-6 WATT, ISOLATION 6000 VDC

Features

- ◆ 5-6W Isolated Output
- ◆ DIP-24 Package
- ◆ Regulated Outputs
- ◆ Efficiency to 85%
- ◆ Continuous Short Circuit Protection
- ◆ I/O Isolation Voltage 6000VDC
- ◆ Reinforced Insulation Rated For Working Voltage 300VAC
- ◆ 5µA Leakage Current
- ◆ EMI Meets EN55022 Class A
- ◆ Safety Meets UL60950-1 and UL60601-1

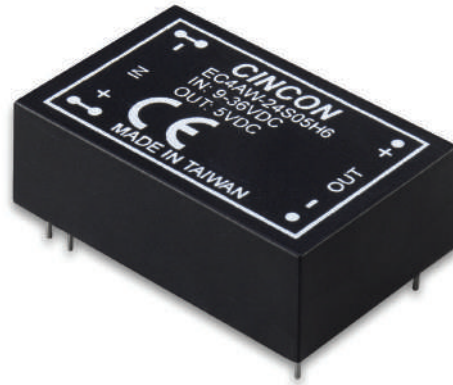

Mechanical Dimensions

NOTE: Pin Size is 0.02" Inch (0.5mm) DIA±0.05
 All Dimensions in Inches (mm)
 Tolerance Inches: X.XX±0.02, X.XXX±0.010
 Millimeters: X.X±0.5, X.XX±0.25

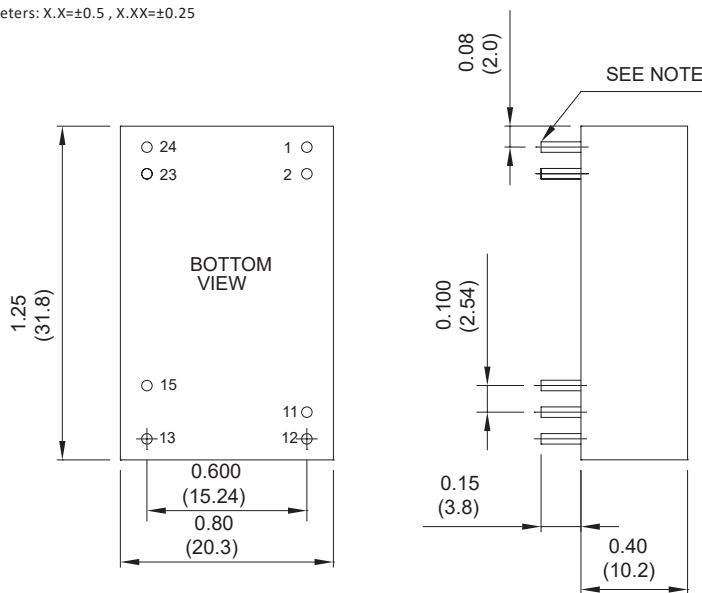

PIN CONNECTION		
PIN	Single Output	Dual Output
1	+V Input	+V Input
2	+V Input	+V Input
11	NP	Common
12	-V Output	NP
13	+V Output	-V Output
15	NP	+V Output
23	-V Input	-V Input
24	-V Input	-V Input

* NP-NO PIN
 * NC-NO CONNECTION WITH PIN

MODEL NUMBER	INPUT VOLTAGE	OUTPUT VOLTAGE	OUTPUT CURRENT		INPUT CURRENT		% EFF.		CAPACITOR LOAD MAX.
			MIN.(4)	MAX.	NO LOAD	FULL LOAD	(2)	(3)	
EC4AW-24S05H6	9-36 VDC	5 VDC	100 mA	1000 mA	10 mA	260 mA	81	80	1000µF
EC4AW-24S12H6	9-36 VDC	12 VDC	50 mA	500 mA	10 mA	295 mA	85.5	85	500µF
EC4AW-24D12H6	9-36 VDC	±12 VDC	25 mA	±250 mA	15 mA	298 mA	84.5	84	250µF
EC4AW-24D15H6	9-36 VDC	±15 VDC	20 mA	±200 mA	15 mA	298 mA	84.5	84	200µF
EC4AW-48S05H6	18-72 VDC	5 VDC	100 mA	1000 mA	5 mA	130 mA	81	80	1000µF
EC4AW-48S12H6	18-72 VDC	12 VDC	50 mA	500 mA	5 mA	149 mA	85	84	500µF
EC4AW-48D12H6	18-72 VDC	±12 VDC	25 mA	±250 mA	8 mA	150 mA	84	83	250µF
EC4AW-48D15H6	18-72 VDC	±15 VDC	20 mA	±200 mA	8 mA	149 mA	85	84	200µF

NOTE:

1. Nominal Input Voltage 24 or 48VDC
2. Measured at 12VDC for 24Vin Models, 24VDC for 48Vin Models
3. Measured at Nominal Input Voltage
4. Operation Under Minimum Load Will not Damage The Converter, But It May not Meet All Specifications

Derating Curve

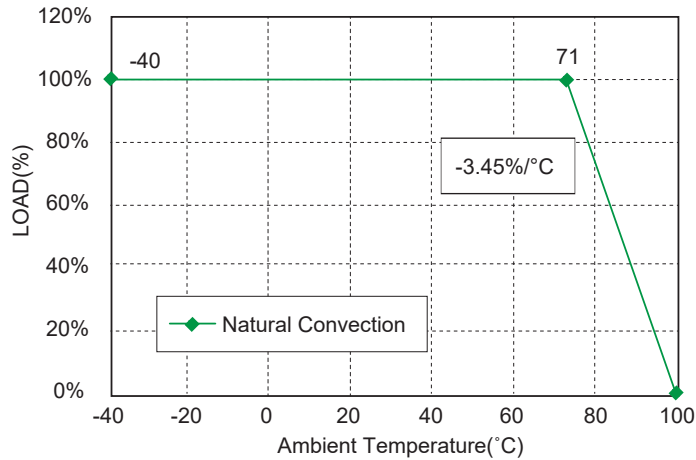

Specifications

All Specifications Typical At Nominal Line, Full Load, and 25°C Unless Otherwise Noted

INPUT SPECIFICATIONS

Input Voltage Range	24Vin 9-36V 48Vin 18-72V
Under Voltage Protection	24Vin power up 8.8V typ. 24Vin power down 8V typ. 48Vin power up 17V typ. 48Vin power down .. 16V typ.
Leakage Current	5uA max.
Input Filter	Pi Type
Input Surge (100ms max.)	24Vin 50V max. 48Vin 100V max.

OUTPUT SPECIFICATIONS

Voltage Accuracy	±1.5% max.
Voltage Balance (Dual)	±2.0% max.
Transient Response: 75%-100% Step Load Change	
Error Band	±6% Vout nominal
Recovery Time	< 500µs
Ripple & Noise, 20MHz BW (with 0.1µF MLCC)	5V 100mV pk-pk max. 12V/15V 1% pk-pk max.
Temperature Coefficient	±0.05%/°C
Line Regulation (note 1)	±0.5% max.
Load Regulation	Single (note 2) ±0.5% max. Dual (note 3) ±1.0% max.
Cross Regulation (Dual output)	
Load Cross Variation 25%/100%	±5% max.
Output Short Circuit Protection	Continuous
Start up Time	1.5ms typ.

GENERAL SPECIFICATIONS

Efficiency	See Table
Isolation Voltage	6000VDC min.
Isolation Resistance	10 ⁹ ohm min.
Isolation Capacitance	40pF typ.
Reinforced Insulation	Creepage Distances8mm min. Air Clearances 8mm min.
Switching Frequency	100KHz min.
Operating Ambient Temperature De-rating, Above 71°C	-40°C to +71°C Linearly to Zero power at 100°C
Case Temperature (note 4)	100°C max.
Storage Temperature	-40°C to +100°C
EMI	Conductive EMI Meet EN55022 Class A
Humidity	95% RH max. Non condensing
MTBF	MIL-HDBK-217-F, GB, 25 °C, Full Load 1430Khrs typ.
Dimensions	1.25 x 0.80 x 0.40 inches (31.8 x 20.3 x 10.2 mm)
Case Material	Non-Conductive Black Plastic
Weight	13.1g

NOTE

1. Measured from high line to low line.
2. Measured from full load to 10% load.
3. Measured from full load to 25% load.
4. Maximum case temperature under any operating condition should not be exceeded 100°C.

AC POWER CORD

C13+US Plug
P/N: G7472205014
LT-202+501

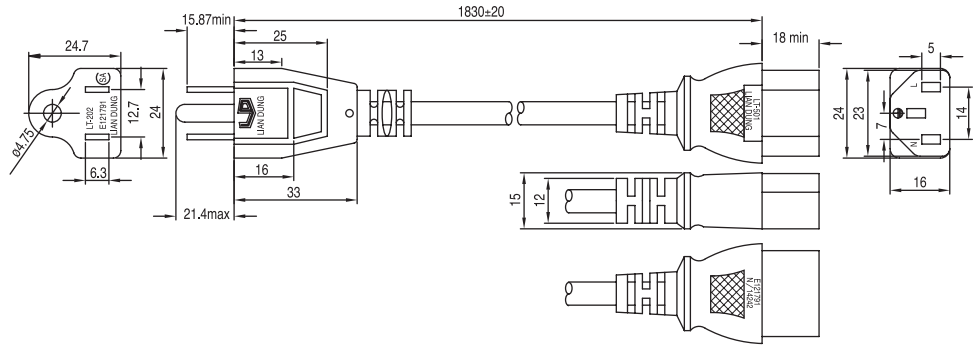

C13+European Plug
P/N: G7472205414
LT-322+501

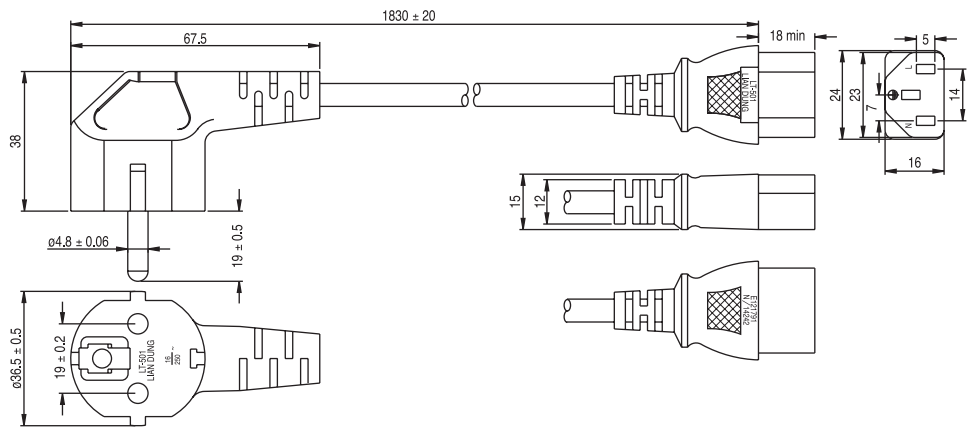

C13+UK Plug
P/N: G7472206214
LT-318+501A

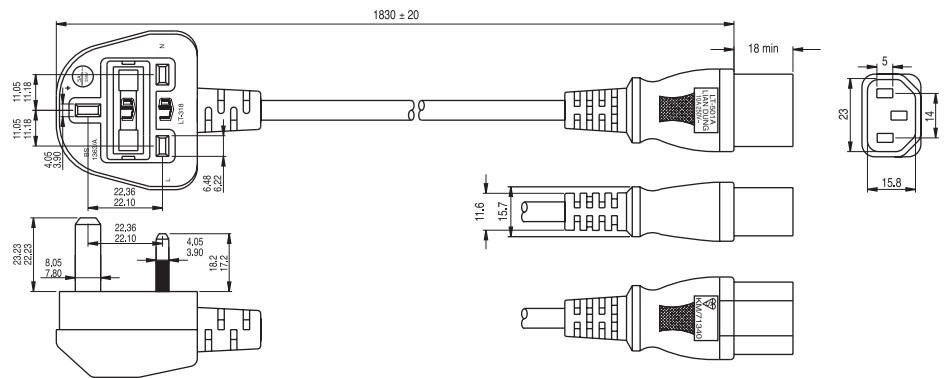

C13+Australian Plug
P/N: G7472205514
LT-208+501

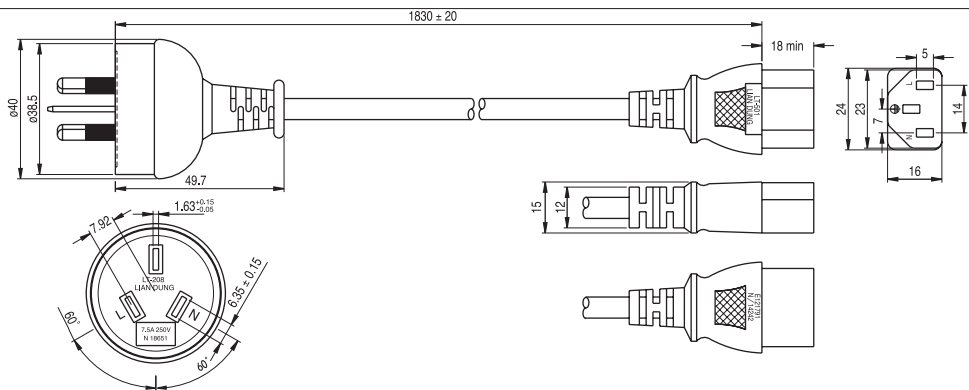

C7+US Plug
P/N: G747205014
LT-301+503

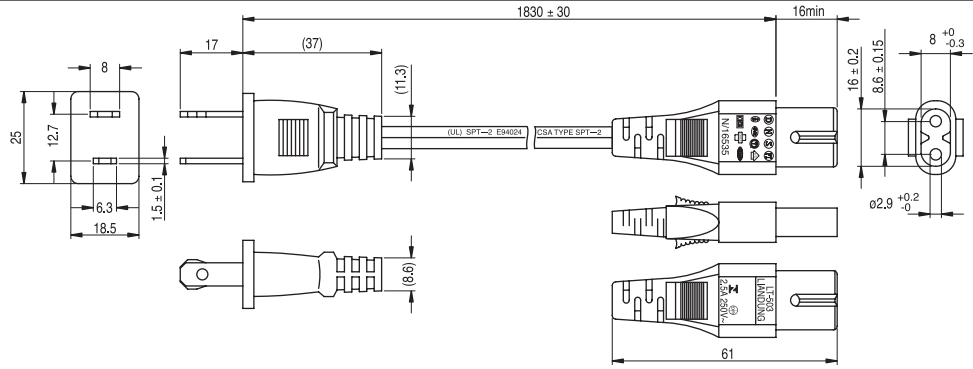

C7+European Plug
P/N: G7472205314
LT-207+503

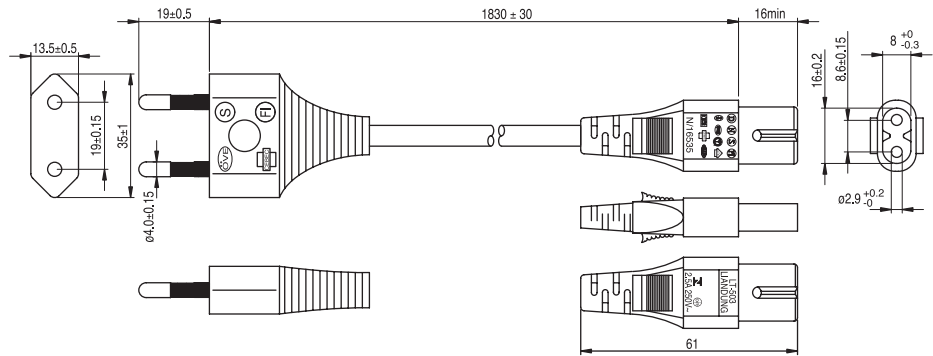

C7+UK Plug
P/N: G7472205214
LT-317+503

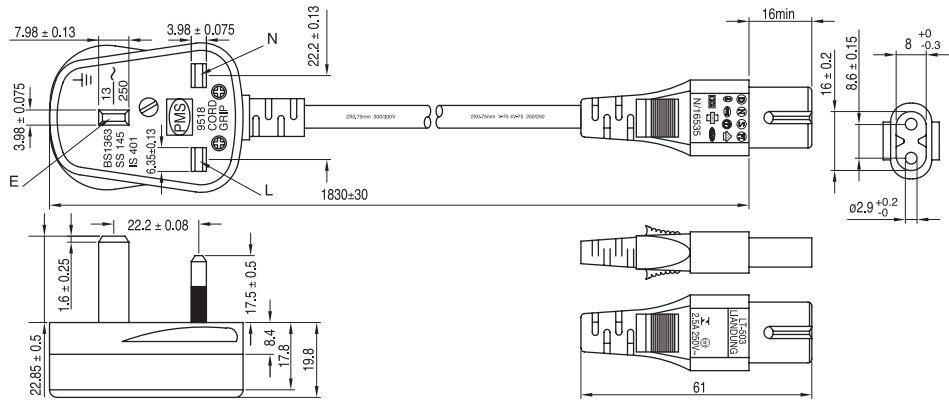

C7+Australian Plug
P/N: G7472207014
LT-219+503

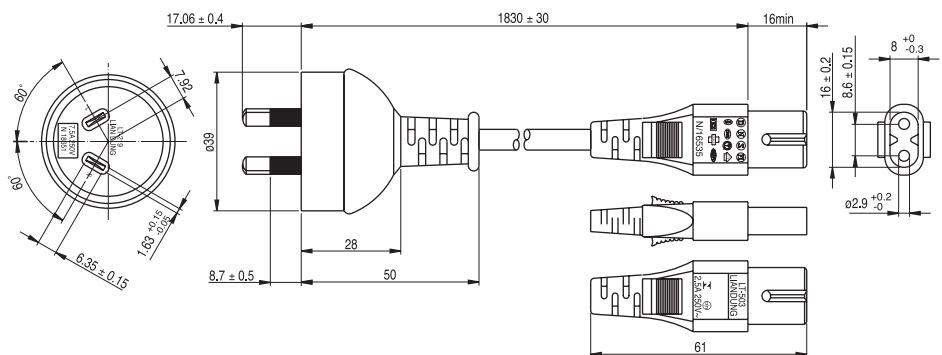





SWITCHING ADAPTER PART NUMBER CONFIGURATION

WALL-MOUNT AC-DC SWITCHING ADAPTER

TRXXX -		XX		X	XX
Model No.	AC Plug Type	DC Plug Type	OVP Option	DC Cable Length and Type	
A : USA 2 Pin		Straight/Inner+Outer-	Right Angle/Inner+Outer-	A: Without OVP Option	01: 720mm
E : Europe 2 Pin		+ — ●) — -	+ — ●) — -	E : With OVP Option	02: 1220mm
U : British 3 Pin		11 : 5.5 x 2.1 x 12mm	01 : 5.5 x 2.1 x 12mm		03: 1800mm
S : Australia 2 Pin		12 : 5.5 x 2.5 x 12mm	02 : 5.5 x 2.5 x 12mm		11: 720mm with Ferrite Core
		18 : 5.5 x 2.5 x 11mm	17 : 5.5 x 2.1 x 11mm		12: 1220mm with Ferrite Core
		23 : 5.5 x 2.1 x 9.5mm	19 : 5.5 x 2.5 x 10.5mm		13: 1800mm with Ferrite Core
		26 : 5.5 x 2.5 x 9.5mm	20 : 5.5 x 2.5 x 9mm		
		32 : 5.5 x 2.1 x 7.5mm	21 : 5.5 x 2.5 x 9.5mm		
		33 : 5.5 x 2.1 x 11.5mm	24 : 5.5 x 2.1 x 9.5mm		
		35 : 4.0 x 1.7 x 9.5mm	31 : 3.5 x 1.35 x 7.5mm		
		37 : 5.5 x 2.5 x 7.5mm	34 : 5.5 x 2.1 x 11.5mm		
		39 : 3.5 x 1.35 x 9mm	36 : 3.5 x 1.35 x 9mm		
		41 : 3.5 x 1.35 x 7.5mm	40 : 4.0 x 1.7 x 9.5mm		
		45 : 4.75 x 1.7 x 9.5mm	42 : 3.5 x 1.35 x 9.5mm		
		50 : 4.0 x 1.7 x 11mm	46 : 4.0 x 1.7 x 12mm		
			48 : 5 x 1.5 x 9.5mm		
			49 : 2.35 x 0.7 x 9.5mm		
		Straight/Inner-Outer+	Right Angle / Inner-Outer+		
		- — ●) — +	- — ●) — +		
		05 : 5.5 x 2.1 x 12mm	03 : 5.5 x 2.1 x 12mm		
		13 : 5.5 x 2.1 x 12mm	04 : 5.5 x 2.5 x 12mm		
		14 : 5.5 x 2.5 x 12mm	16 : 5.5 x 2.1 x 11mm		
		27 : 5.5 x 2.5 x 9.5mm	22 : 5.5 x 2.5 x 9.5mm		
			43 : 5.5 x 2.1 x 9.5mm		
			44 : 3.5 x 1.35 x 7.5mm		
			105 : 3.5 x 1.05 x 9.5mm		
			111 : 3.5 x 1.35 x 9.5mm		
			122 : 3.5 x 1.35 x 12mm		
			141 : 5.5 x 2.1 x 11mm		
			150 : 3.5 x 1.35 x 9mm		
			317 : 5.5 x 2.5 x 9mm		

DESK-TOP AC-DC SWITCHING ADAPTER

TRXXXXX -	XX	X	XX	
Model No.	DC Plug Type	OVP Option	DC Cable Length and Type	
	Straight/Inner+Outer-  11 : 5.5 x 2.1 x 12mm 12 : 5.5 x 2.5 x 12mm 18 : 5.5 x 2.5 x 11mm 23 : 5.5 x 2.1 x 9.5mm 26 : 5.5 x 2.5 x 9.5mm 32 : 5.5 x 2.1 x 7.5mm 33 : 5.5 x 2.1 x 11.5mm 35 : 4.0 x 1.7 x 9.5mm 37 : 5.5 x 2.5 x 7.5mm 39 : 3.5 x 1.35 x 9mm 41 : 3.5 x 1.35 x 7.5mm 45 : 4.75 x 1.7 x 9.5mm 50 : 4.0 x 1.7 x 11mm	Right Angle/Inner+Outer-  01 : 5.5 x 2.1 x 12mm 02 : 5.5 x 2.5 x 12mm 17 : 5.5 x 2.1 x 11mm 19 : 5.5 x 2.5 x 10.5mm 20 : 5.5 x 2.5 x 9mm 21 : 5.5 x 2.5 x 9.5mm 24 : 5.5 x 2.1 x 9.5mm 31 : 3.5 x 1.35 x 7.5mm 34 : 5.5 x 2.1 x 11.5mm 36 : 3.5 x 1.35 x 9mm 40 : 4.0 x 1.7 x 9.5mm 42 : 3.5 x 1.35 x 9.5mm 46 : 4.0 x 1.7 x 12mm 48 : 5 x 1.5 x 9.5mm 49 : 2.35 x 0.7 x 9.5mm	A: Without OVP Option E : With OVP Option	01: 720mm 02: 1220mm 03: 1800mm 11: 720mm with Ferrite Core 12: 1220mm with Ferrite Core 13: 1800mm with Ferrite Core
	Straight/Inner-Outer+  05 : 5.5 x 2.1 x 12mm 13 : 5.5 x 2.1 x 12mm 14 : 5.5 x 2.5 x 12mm 27 : 5.5 x 2.5 x 9.5mm	Right Angle/Inner-Outer+  03 : 5.5 x 2.1 x 12mm 04 : 5.5 x 2.5 x 12mm 16 : 5.5 x 2.1 x 11mm 22 : 5.5 x 2.5 x 9.5mm 43 : 5.5 x 2.1 x 9.5mm 44 : 3.5 x 1.35 x 7.5mm		

Cincon offers a wide variety of DC plugs for every customers.

Please contact your distributor or E-Mail sales@cincon.com.tw for more information.

Rapid Standard-Modification, Value Added & Customized Power Supplies. Cincon offers a high degree of flexibility in product designs.

Cincon provides a broad range of standard products that address the needs of many applications, there are occasions when a standard product doesn't address all your application requirements.

By years of experience in developing our customers with solutions on demand, do not hesitate to talk to Cincon to obtain your preferred products.

Cincon Headquarters

14F, No. 306, Section 4, Hsin Yi Rd., Taipei, Taiwan
Tel: (886-2) 2708-6210
E-mail: sales@cincon.com.tw

Cincon USA

1655 Mesa Verde Ave, Ste 180
Ventura, CA 93003 USA
Tel: (805) 639-3350
E-mail: info@cincon.com

POWER SUPPLY - REQUEST FOR QUOTE - by fax +886 2 2702 9852

Company _____ Date _____

First Name _____ Last Name _____

Country _____ City _____

Address _____

Telephone _____ Fax _____

E-mail _____

Product Type

Application

Output Voltages

Output Currents

Input Voltages

Efficiency

Isolation

Protection

Storage / Operating Temperature Range

Safety Standard

EMC Standard

Mechanical Description

Remarks

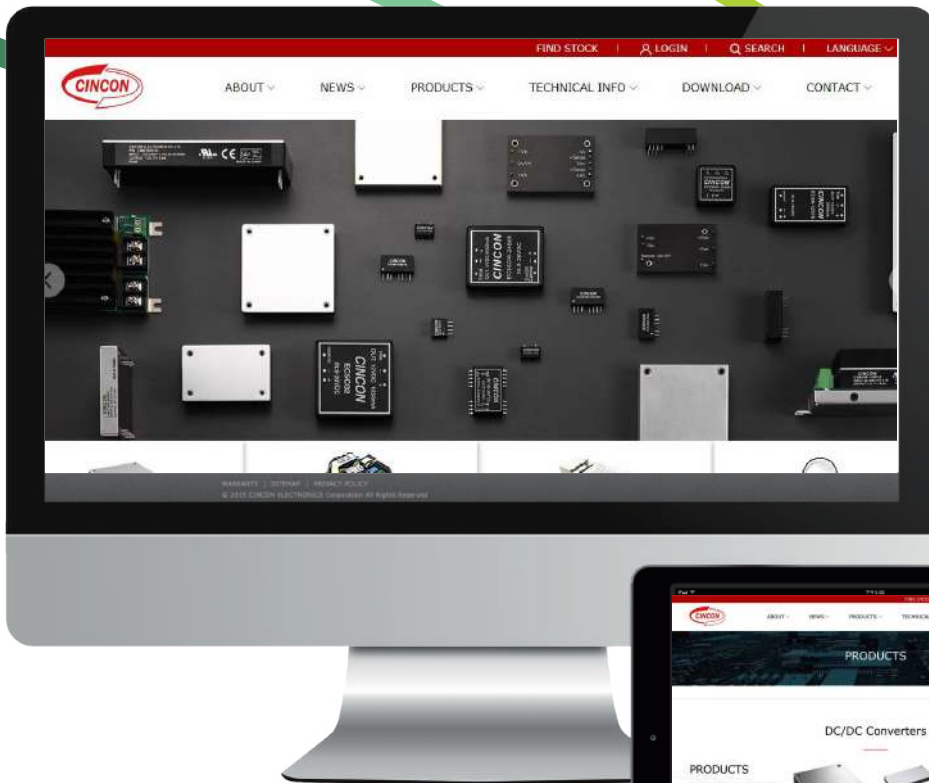

Visit Our Website
WWW.CINCON.COM

On Cincon Website

- ✓ You can download latest datasheets & application notes
- ✓ You can find all new product releases and latest news
- ✓ You can find Cincon sales representative & distributors
- ✓ You can check stock and send product inquiry to us

Let Cincon Power Your Idea

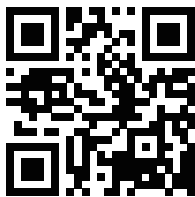

WWW.CINCON.COM

CINCON HEADQUARTERS

14F , No. 306, Section 4, Hsin Yi Road Taipei, Taiwan, R.O.C.

Tel : (886-2) 2708-6210 | Fax : (886-2) 2702-9852

E-mail : sales@cincon.com.tw

CINCON USA

1655 Mesa Verde Ave, Ste 180 Ventura , CA 93003 USA

Tel : (805) 639-3350 | Fax : (805) 639-4101

E-mail : info@cincon.com