

IoT OPTIMIZED LOW PROFILE QUARTZ CRYSTAL

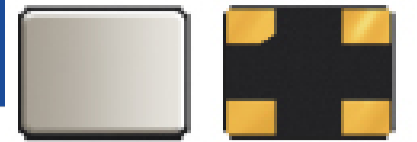

ABM11W SERIES

2.0 x 1.6 x 0.5mm



RoHS/RoHS II Compliant

MSL = N/A: NOT APPLICABLE

FEATURES

- Optimized for energy saving wearables, and IoT applications
- Plated at exceptionally low plating capacitance, as low as 4pF, with optimized ESR
- 0.5 mm max height ideally suited for height constrained designs
- Seam sealed for longterm reliability

APPLICATIONS

- Wearables
- Internet of Things (IoT)
- Bluetooth/Bluetooth Low Energy (BLE)
- Wireless modules
- Machine-to-machine (M2M) connectivity
- Ultra-low power MCU
- Near Field Communication (NFC)
- ISM Band

STANDARD SPECIFICATIONS

Parameters	Minimum	Typical	Maximum	Units	Notes
Frequency Range	16.0000		50.0000	MHz	
Operation Mode	Fundamental				
Operating Temperature Range	-40		+125	°C	See options
Storage Temperature	-55		+125	°C	
Frequency Tolerance @ +25°C	-10		+10	ppm	See options
Frequency Stability over the Operating Temperature (ref. to +25°C)	-10		+10	ppm	See options
Equivalent series resistance "R1" (over Operating Temperature Range) (CL=4pF)		< 150	200	Ω	16.0000 – 17.9999MHz
		< 80	120		18.0000 – 20.9999MHz
		< 60	100		21.0000 – 29.9999MHz
		< 50	80		30.0000 – 37.9999MHz
		< 30	60		38.0000 – 50.0000MHz
Equivalent series resistance "R1" (over Operating Temperature Range) (CL=6pF, 7pF, 8pF)		< 120	150	Ω	16.0000 – 17.9999MHz
		< 80	120		18.0000 – 20.9999MHz
		< 60	100		21.0000 – 23.9999MHz
		< 30	50		24.0000 – 29.9999MHz
		< 30	50		30.0000 – 37.9999MHz
		< 30	40		38.0000 – 50.0000MHz
Shunt capacitance (C0)		< 1.0	2.0	pF	
Load capacitance (CL)		4.0		pF	See options
Drive Level		10	100	μW	
Aging (1 year)	-2		+2	ppm	@ 25°C±3°C
Insulation Resistance	500			MΩ	@ 100Vdc ± 15V

IoT OPTIMIZED LOW PROFILE QUARTZ CRYSTAL

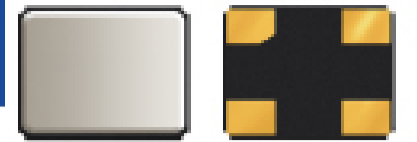

ABM11W SERIES

2.0 x 1.6 x 0.5mm



RoHS/RoHS II Compliant

MSL = N/A: NOT APPLICABLE

OPTIONS AND PART IDENTIFICATION (NOTE 1)

Note 1: Contact Abracon for part number requests with carrier frequency callouts up to 5 & 6 digit accuracy after the decimal.

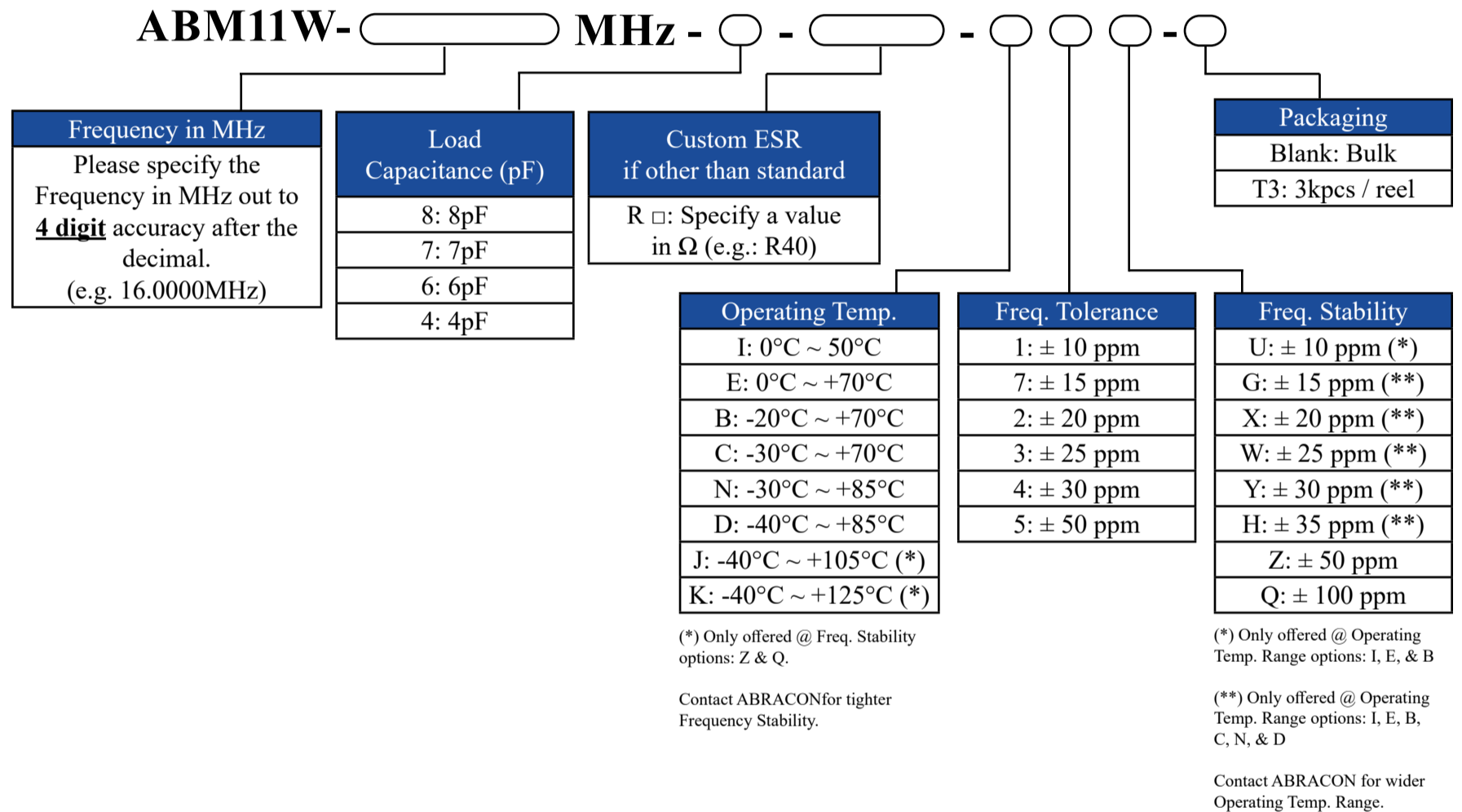

IoT OPTIMIZED LOW PROFILE QUARTZ CRYSTAL

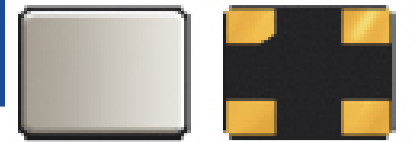

ABM11W SERIES

2.0 x 1.6 x 0.5mm



RoHS/RoHS II Compliant

MSL = N/A: NOT APPLICABLE

TYPICAL FREQUENCY Vs. TEMPERATURE CHARACTERISTICS

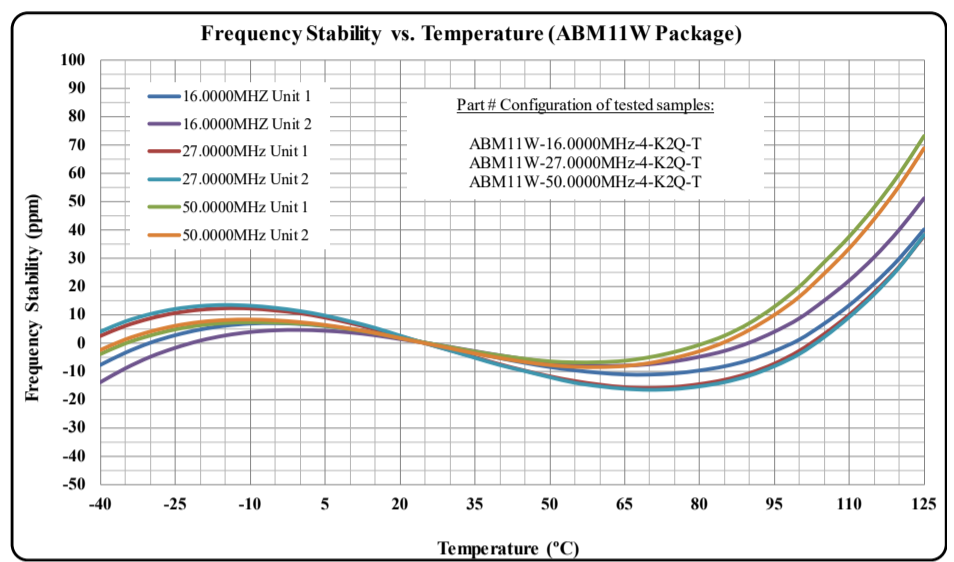
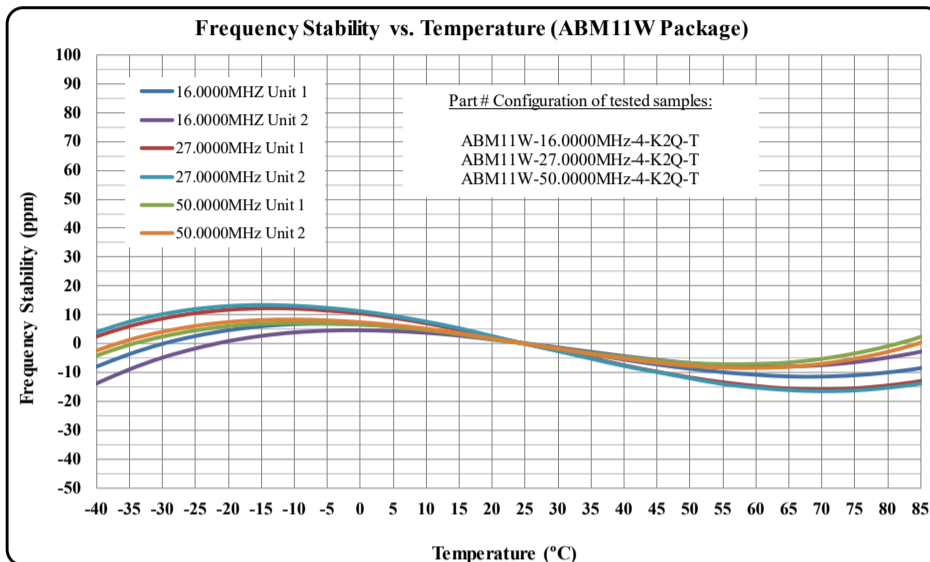

TYPICAL ESR (EQUIVALENT SERIES RESISTANCE) Vs. TEMPERATURE CHARACTERISTICS

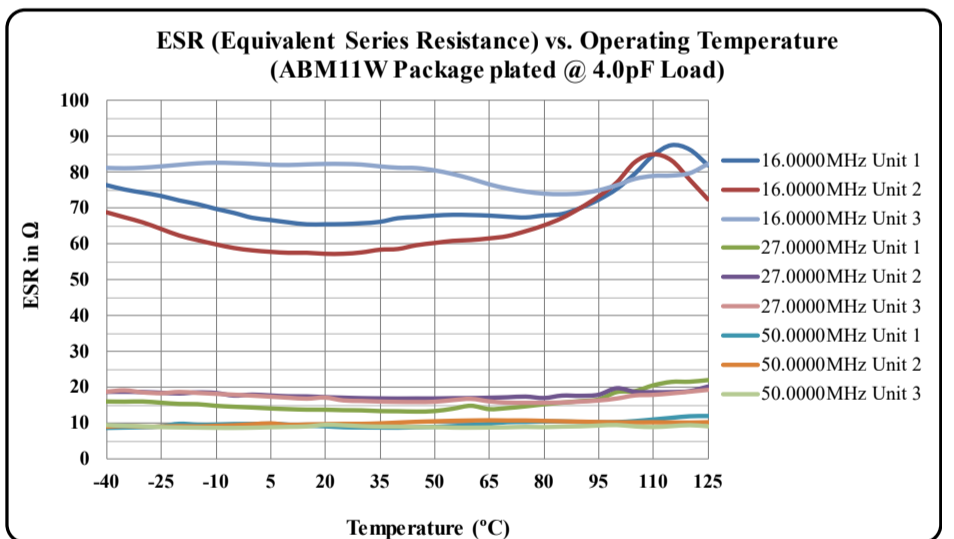
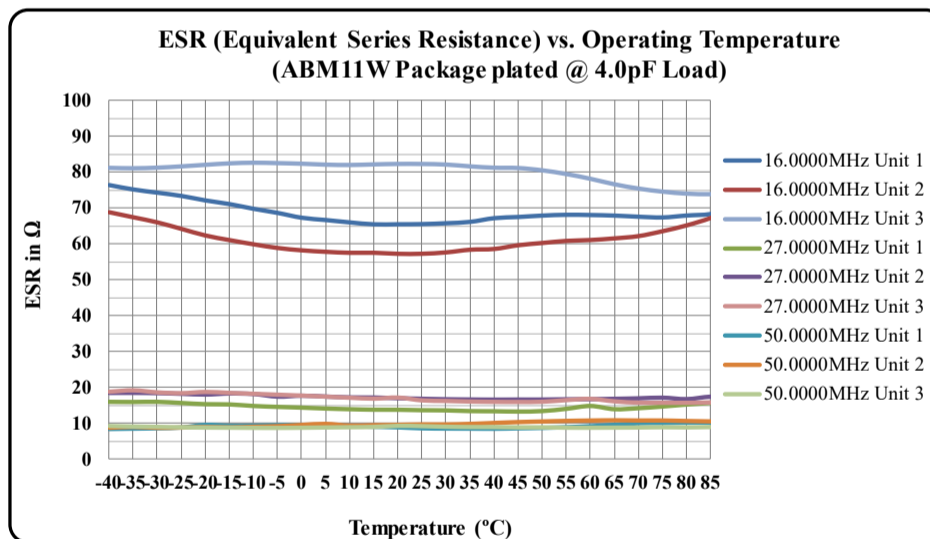

(*) Plating Load = Load Capacitance (CL)



5101 Hidden Creek Ln Spicewood TX 78669
 Phone: 512-371-6159 | Fax: 512-351-8858
 For terms and conditions of sales, please visit:
www.abracon.com

REVISED: 10.06.2020

ABRACON IS
 ISO9001-2015
 CERTIFIED

IoT OPTIMIZED LOW PROFILE QUARTZ CRYSTAL

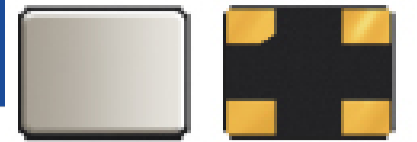

ABM11W SERIES

2.0 x 1.6 x 0.5mm



RoHS/RoHS II Compliant

MSL = N/A: NOT APPLICABLE

TYPICAL FREQUENCY TOLERANCE DISTRIBUTION (AT 25°C ± 3°C)

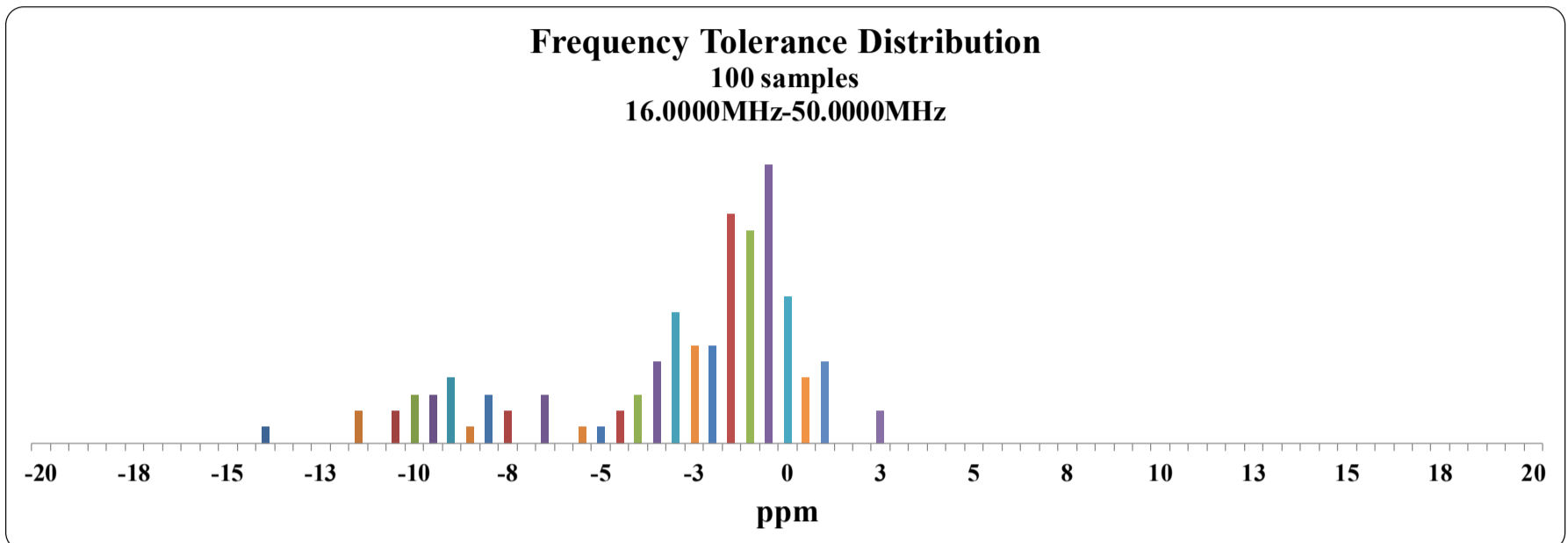

TYPICAL ESR DISTRIBUTION (AT 25°C ± 3°C)

ESR Distribution @ 16.0000MHz

100 samples
MAX ESR = 89.5 Ω

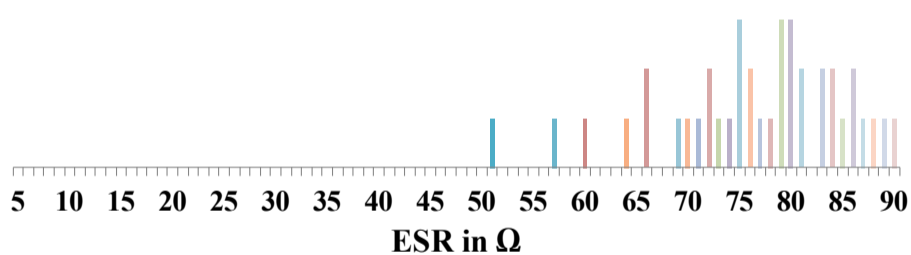

ESR Distribution @ 27.0000MHz

100 samples
MAX ESR = 28.3 Ω

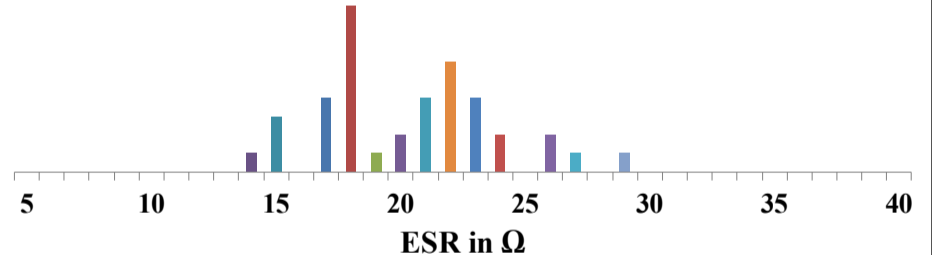

ESR Distribution @ 50.0000MHz

100 samples
MAX ESR = 13.4 Ω

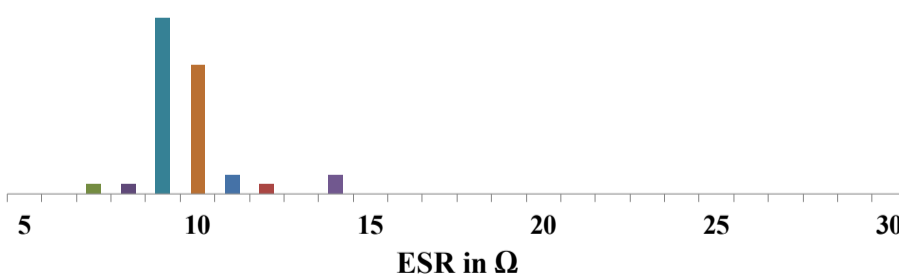

IoT OPTIMIZED LOW PROFILE QUARTZ CRYSTAL



ABM11W SERIES

2.0 x 1.6 x 0.5mm



RoHS/RoHS II Compliant

MSL = N/A: NOT APPLICABLE

SPICE MODELS (BASED ON TYPICAL VALUES AT 25°C ± 3°C)

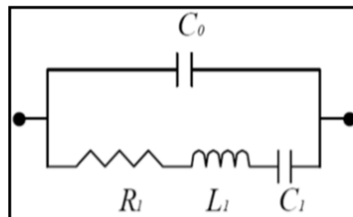

Frequency: 16.0000MHz Plating Load: 4pF		Frequency: 16.0000MHz Plating Load: 6pF	
C0	= 0.73 pF	C0	= 0.71 pF
R1	= 73.02 Ω	R1	= 81.42 Ω
L1	= 84.25 mH	L1	= 81.33 mH
C1	= 1.18 fF	C1	= 1.22 fF
Frequency: 27.0000MHz Plating Load: 4pF		Frequency: 27.0000MHz Plating Load: 6pF	
C0	= 0.78 pF	C0	= 0.76 pF
R1	= 18.71 Ω	R1	= 20.45 Ω
L1	= 18.08 mH	L1	= 18.44 mH
C1	= 1.92 fF	C1	= 1.89 fF
Frequency: 50.0000MHz Plating Load: 4pF		Frequency: 50.0000MHz Plating Load: 6pF	
C0	= 0.92 pF	C0	= 0.97 pF
R1	= 9.02 Ω	R1	= 8.49 Ω
L1	= 3.53 mH	L1	= 3.21 mH
C1	= 2.88 fF	C1	= 3.15 fF

MECHANICAL DIMENSIONS

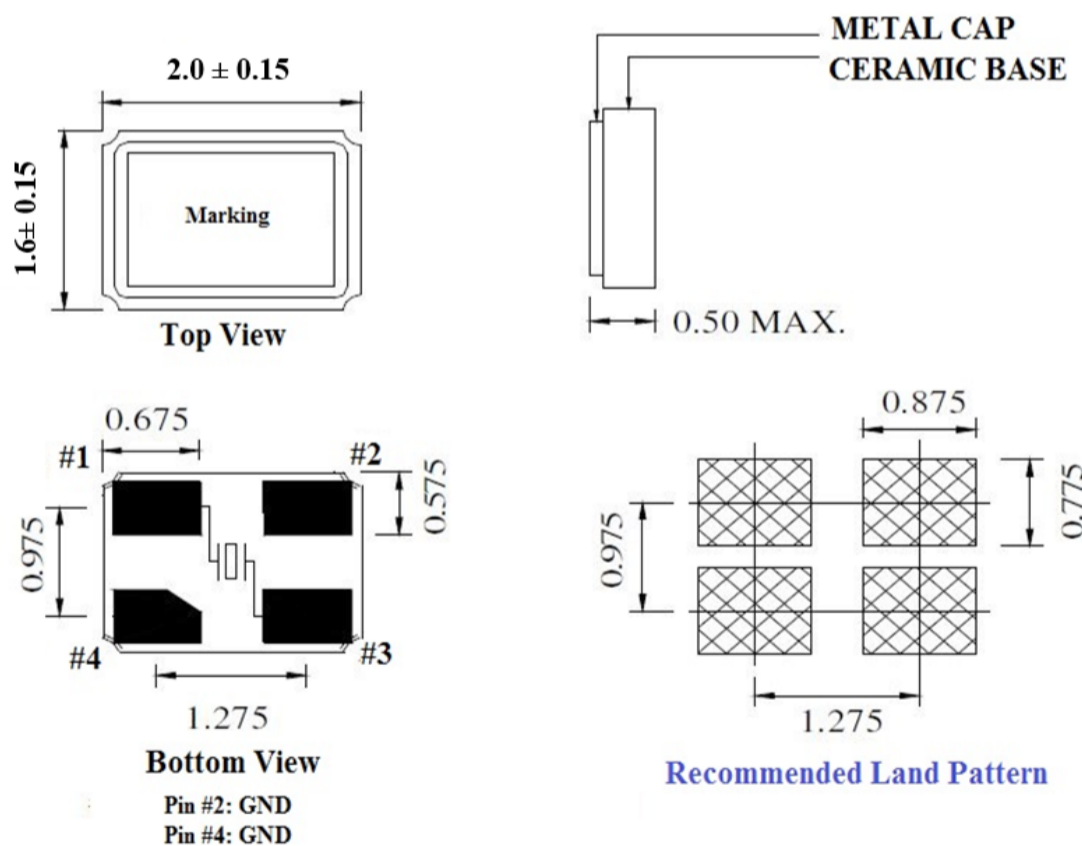

Note:

Due to material availability the Chamfer could be located on pin #1, 2 or 4. Be advised that the Chamfer location has no impact on the electrical performance of the device.

DIMENSIONS: MM



5101 Hidden Creek Ln Spicewood TX 78669
 Phone: 512-371-6159 | Fax: 512-351-8858
 For terms and conditions of sales, please visit:
www.abracon.com

REVISED: 10.06.2020

ABRACON IS
 ISO9001-2015
 CERTIFIED

IoT OPTIMIZED LOW PROFILE QUARTZ CRYSTAL

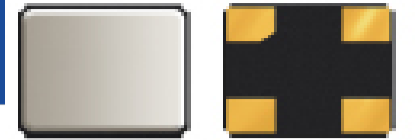

ABM11W SERIES

2.0 x 1.6 x 0.5mm



RoHS/RoHS II Compliant

MSL = N/A: NOT APPLICABLE

REFLOW PROFILE

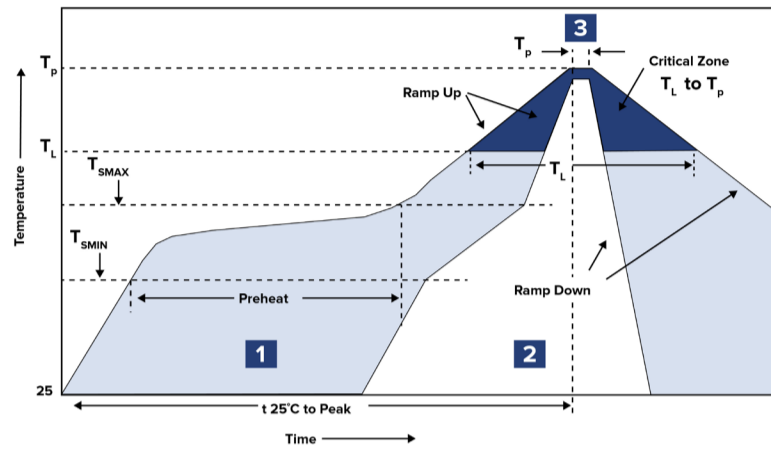

Zone	Description	Temperature	Time
1	Preheat	$T_{SMIN} \sim T_{SMAX}$ 150°C ~ 180°C	60 ~ 120 sec.
2	Reflow	T_L 217°C	45 ~ 90 sec.
3	Peak Heat	T_P 260°C MAX	10 sec.

PACKAGING

T3: Tape and reel (3,000 pcs/reel)

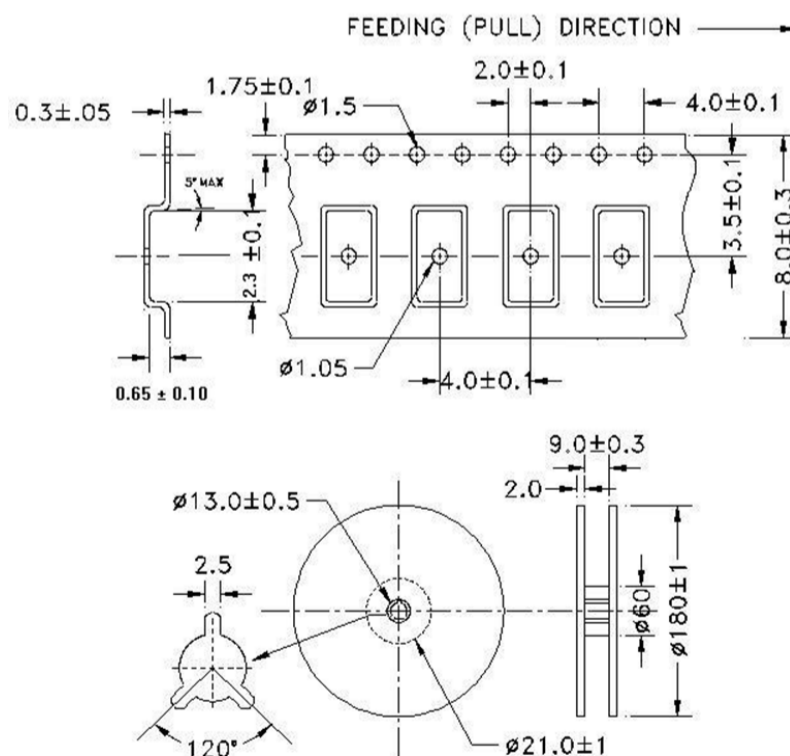

DIMENSIONS: mm



5101 Hidden Creek Ln Spicewood TX 78669
 Phone: 512-371-6159 | Fax: 512-351-8858
 For terms and conditions of sales, please visit:
www.abracon.com

REVISED: 10.06.2020

ABRACON IS
 ISO9001-2015
 CERTIFIED