

FEATURES

- 100 MSPS guaranteed sampling rate (AD9446-100)
- 83.6 dBFS SNR with 30 MHz input (3.8 V p-p input, 80 MSPS)
- 82.6 dBFS SNR with 30 MHz input (3.2 V p-p input, 80 MSPS)
- 89 dBc SFDR with 30 MHz input (3.2 V p-p input, 80 MSPS)
- 95 dBFS 2-tone SFDR with 9.8 MHz and 10.8 MHz (100 MSPS)
- 60 fsec rms jitter
- Excellent linearity
 - DNL = ± 0.4 LSB typical
 - INL = ± 3.0 LSB typical
- 2.0 V p-p to 4.0 V p-p differential full-scale input
- Buffered analog inputs
- LVDS outputs (ANSI-644 compatible) or CMOS outputs
- Data format select (offset binary or twos complement)
- Output clock available
- 3.3 V and 5 V supply operation

APPLICATIONS

- MRI receivers
- Multicarrier, multimode cellular receivers
- Antenna array positioning
- Power amplifier linearization
- Broadband wireless
- Radar
- Infrared imaging
- Communications instrumentation

GENERAL DESCRIPTION

The AD9446 is a 16-bit, monolithic, sampling analog-to-digital converter (ADC) with an on-chip track-and-hold circuit. It is optimized for performance, small size, and ease of use. The product operates up to a 100 MSPS, providing superior SNR for instrumentation, medical imaging, and radar receivers employing baseband (<100 MHz) IF frequencies.

The ADC requires 3.3 V and 5.0 V power supplies and a low voltage differential input clock for full performance operation. No external reference or driver components are required for many applications. Data outputs are CMOS or LVDS compatible (ANSI-644 compatible) and include the means to reduce the overall current needed for short trace distances.

FUNCTIONAL BLOCK DIAGRAM

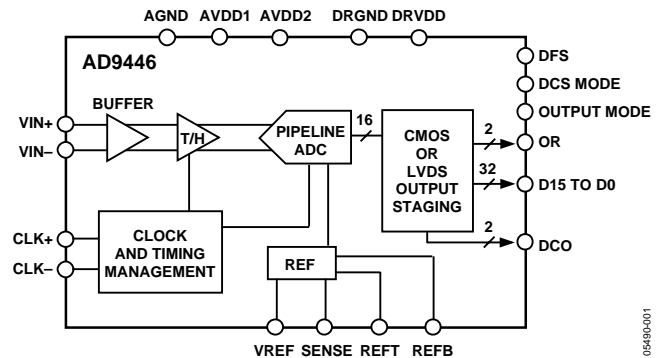

Figure 1.

Optional features allow users to implement various selectable operating conditions, including input range, data format select, and output data mode.

The AD9446 is available in a Pb-free, 100-lead, surface-mount, plastic package (100-lead TQFP/EP) specified over the industrial temperature range -40°C to $+85^{\circ}\text{C}$.

PRODUCT HIGHLIGHTS

1. True 16-bit linearity.
2. High performance: outstanding SNR performance for baseband IFs in data acquisition, instrumentation, magnetic resonance imaging, and radar receivers.
3. Ease of use: on-chip reference and high input impedance track-and-hold with adjustable analog input range and an output clock simplifies data capture.
4. Packaged in a Pb-free, 100-lead TQFP/EP package.
5. Clock duty cycle stabilizer (DCS) maintains overall ADC performance over a wide range of clock pulse widths.
6. OR (out-of-range) outputs indicate when the signal is beyond the selected input range.

Rev. 0

Information furnished by Analog Devices is believed to be accurate and reliable. However, no responsibility is assumed by Analog Devices for its use, nor for any infringements of patents or other rights of third parties that may result from its use. Specifications subject to change without notice. No license is granted by implication or otherwise under any patent or patent rights of Analog Devices. Trademarks and registered trademarks are the property of their respective owners.

TABLE OF CONTENTS

Features	1	Terminology	9
Applications.....	1	Pin Configurations and Function Descriptions	10
General Description	1	Equivalent Circuits.....	15
Functional Block Diagram	1	Typical Performance Characteristics	16
Product Highlights	1	Theory of Operation	24
Revision History	2	Analog Input and Reference Overview	24
Specifications.....	3	Clock Input Considerations.....	26
DC Specifications	3	Power Considerations.....	27
AC Specifications.....	4	Digital Outputs	27
Digital Specifications	6	Timing	27
Switching Specifications	6	Operational Mode Selection	28
Timing Diagrams.....	7	Evaluation Board	29
Absolute Maximum Ratings.....	8	Outline Dimensions	36
Thermal Resistance	8	Ordering Guide	36
ESD Caution.....	8		

REVISION HISTORY**10/05—Revision 0: Initial Version**

SPECIFICATIONS

DC SPECIFICATIONS

AVDD1 = 3.3 V, AVDD2 = 5.0 V, DRVDD = 3.3 V, LVDS mode, specified minimum sampling rate, 3.2 V p-p differential input, internal trimmed reference (1.6 V mode), $A_{IN} = -1.0$ dBFS, DCS on, unless otherwise noted.

Table 1.

Parameter	Temp	AD9446BSVZ-80			AD9446BSVZ-100			Unit
		Min	Typ	Max	Min	Typ	Max	
RESOLUTION	Full	16			16			Bits
ACCURACY		Guaranteed			Guaranteed			
No Missing Codes	Full							
Offset Error	Full	-5	±0.1	+5	-5	±0.1	+5	mV
Gain Error	Full	-3	±0.6	+3	-3	±0.5	+3	% FSR
	25°C	-2	±0.3	+2	-2	±0.3	+2	% FSR
Differential Nonlinearity (DNL) ¹	Full	-0.75	±0.4	+0.75	-0.85	±0.4	+0.85	LSB
Integral Nonlinearity (INL) ¹	25°C	-5	±3.0	+5	-6	±3.0	+6	LSB
VOLTAGE REFERENCE								
Output Voltage ¹								
VREF = 1.6 V (3.2 V p-p Analog Input Range)	Full	1.6			1.6			V
Load Regulation @ 1.0 mA	Full	±2			±2			mV
Reference Input Current (External 1.6 V Reference)	Full							µA
INPUT REFERRED NOISE	25°C	1.5			1.9			LSB rms
ANALOG INPUT								
Input Span								
VREF = 1.6 V	Full	3.2			3.2			V p-p
VREF = 1.0 V (External)	Full	2.0			2.0			V p-p
Internal Input Common-Mode Voltage	Full	3.5			3.5			V
External Input Common-Mode Voltage	Full	3.2		3.8	3.2		3.8	V
Input Resistance ²	Full	1			1			kΩ
Input Capacitance ²	Full	6			6			pF
POWER SUPPLIES								
Supply Voltage								
AVDD1	Full	3.14	3.3	3.46	3.14	3.3	3.46	V
AVDD2	Full	4.75	5.0	5.25	4.75	5.0	5.25	V
DRVDD—LVDS Outputs	Full	3.0	3.3	3.6	3.0	3.3	3.6	V
DRVDD—CMOS Outputs	Full	3.0	3.3	3.6	3.0	3.3	3.6	V
Supply Current								
I_{AVDD1}	Full	335		365	368		401	mA
I_{AVDD2}	Full	204		234	223		255	mA
I_{DRVDD1} —LVDS Outputs	Full	68		75	69		75	mA
I_{DRVDD1} —CMOS Outputs	Full	14			14			mA
PSRR								
Offset	Full	1			1			mV/V
Gain	Full	0.2			0.2			%/V
POWER CONSUMPTION								
LVDS Outputs	Full	2.4		2.6	2.6		2.8	W
CMOS Outputs (DC Input)	Full	2.2			2.3			W

¹ Measured at the maximum clock rate, $f_{IN} = 15$ MHz, full-scale sine wave, with a 100 Ω differential termination on each pair of output bits for LVDS output mode and approximately 5 pF loading on each output bit for CMOS output mode.

² Input capacitance or resistance refers to the effective impedance between one differential input pin and AGND. Refer to Figure 6 for the equivalent analog input structure.

AD9446

AC SPECIFICATIONS

AVDD1 = 3.3 V, AVDD2 = 5.0 V, DRVDD = 3.3 V, LVDS mode, specified minimum sample rate, 3.2 V p-p differential input, internal trimmed reference (1.6 V mode), $A_{IN} = -1$ dBFS, DCS on, unless otherwise noted.

Table 2.

Parameter	Temp	AD9446BSVZ-80			AD9446BSVZ-100			Unit
		Min	Typ	Max	Min	Typ	Max	
SIGNAL-TO-NOISE RATIO (SNR)								
$f_{IN} = 10$ MHz	25°C	79.6	81.8		78.4	79.7		dB
$f_{IN} = 30$ MHz	25°C	80.5	81.6		78.3	79.5		dB
	Full	79.2			77.9			dB
$f_{IN} = 70$ MHz	25°C	79.0	80.6		77.7	79.0		dB
	Full	78.2			77.6			dB
$f_{IN} = 92$ MHz	25°C		80.1			78.9		dB
$f_{IN} = 125$ MHz	25°C		78.8			78.2		dB
$f_{IN} = 170$ MHz	25°C		77.1			77.0		dB
$f_{IN} = 10$ MHz (2 V p-p Input)	25°C		78.3			76.6		dB
$f_{IN} = 30$ MHz (2 V p-p Input)	25°C		78.3			76.6		dB
$f_{IN} = 70$ MHz (2 V p-p Input)	25°C		77.6			76.2		dB
$f_{IN} = 92$ MHz (2 V p-p Input)	25°C		77.5			76		dB
$f_{IN} = 125$ MHz (2 V p-p Input)	25°C		76.7			75.6		dB
$f_{IN} = 170$ MHz (2 V p-p Input)	25°C		75.5			75.1		dB
SIGNAL-TO-NOISE AND DISTORTION (SINAD)								
$f_{IN} = 10$ MHz	25°C	77.1	80.5		76.9	78.9		dB
$f_{IN} = 30$ MHz	25°C	75.9	80.4		75.5	78.6		dB
	Full	74.9			71.7			dB
$f_{IN} = 70$ MHz	25°C	75.5	78.6		73.8	77.7		dB
	Full	74.4			69.1			dB
$f_{IN} = 92$ MHz	25°C		79.2			77.1		dB
$f_{IN} = 125$ MHz	25°C		74.9			76.9		dB
$f_{IN} = 170$ MHz	25°C		66.0			70.5		dB
$f_{IN} = 10$ MHz (2 V p-p Input)	25°C		77.9			76.2		dB
$f_{IN} = 30$ MHz (2 V p-p Input)	25°C		77.8			76.1		dB
$f_{IN} = 70$ MHz (2 V p-p Input)	25°C		77.1			75.9		dB
$f_{IN} = 92$ MHz (2 V p-p Input)	25°C		77.1			75.7		dB
$f_{IN} = 125$ MHz (2 V p-p Input)	25°C		75.7			75.3		dB
$f_{IN} = 170$ MHz (2 V p-p Input)	25°C		72.5			73.6		dB
EFFECTIVE NUMBER OF BITS (ENOB)								
$f_{IN} = 10$ MHz	25°C		13.2			13.0		Bits
$f_{IN} = 30$ MHz	25°C		13.2			12.9		Bits
$f_{IN} = 70$ MHz	25°C		12.9			12.8		Bits
$f_{IN} = 92$ MHz	25°C		13.0			12.7		Bits
$f_{IN} = 125$ MHz	25°C		12.3			12.6		Bits
$f_{IN} = 170$ MHz	25°C		10.8			11.6		Bits

Parameter	Temp	AD9446BSVZ-80			AD9446BSVZ-100			Unit
		Min	Typ	Max	Min	Typ	Max	
SPURIOUS-FREE DYNAMIC RANGE (SFDR, Second or Third Harmonic)								
$f_{IN} = 10$ MHz	25°C	82	90		82	92		dBc
$f_{IN} = 30$ MHz	25°C	82	89		82	89		dBc
	Full	80			79			dBc
$f_{IN} = 70$ MHz	25°C	80	87		81	89		dBc
	Full	79			77			dBc
$f_{IN} = 92$ MHz	25°C		84			84		dBc
$f_{IN} = 125$ MHz	25°C		80			83		dBc
$f_{IN} = 170$ MHz	25°C		66			74		dBc
$f_{IN} = 10$ MHz (2 V p-p Input)	25°C		92			94		dBc
$f_{IN} = 30$ MHz (2 V p-p Input)	25°C		93			92		dBc
$f_{IN} = 70$ MHz (2 V p-p Input)	25°C		92			92		dBc
$f_{IN} = 92$ MHz (2 V p-p Input)	25°C		90			89		dBc
$f_{IN} = 125$ MHz (2 V p-p Input)	25°C		85			87		dBc
$f_{IN} = 170$ MHz (2 V p-p Input)	25°C		77			82		dBc
WORST SPUR EXCLUDING SECOND OR THIRD HARMONICS								
$f_{IN} = 10$ MHz	25°C		-98	-89		-96	-91	dBc
$f_{IN} = 30$ MHz	25°C		-97	-89		-97	-89	dBc
	Full			-89			-87	dBc
$f_{IN} = 70$ MHz	25°C		-98	-90		-96	-90	dBc
	Full			-89			-88	dBc
$f_{IN} = 92$ MHz	25°C		-98			-95		dBc
$f_{IN} = 125$ MHz	25°C		-96			-96		dBc
$f_{IN} = 170$ MHz	25°C		-95			-92		dBc
$f_{IN} = 10$ MHz (2 V p-p Input)	25°C		-97			-93		dBc
$f_{IN} = 30$ MHz (2 V p-p Input)	25°C		-97			-96		dBc
$f_{IN} = 70$ MHz (2 V p-p Input)	25°C		-94			-94		dBc
$f_{IN} = 92$ MHz (2 V p-p Input)	25°C		-97			-99		dBc
$f_{IN} = 125$ MHz (2 V p-p Input)	25°C		-97			-95		dBc
$f_{IN} = 170$ MHz (2 V p-p Input)	25°C		-93			-95		dBc
TWO-TONE SFDR								
$f_{IN} = 10.8$ MHz @ -7 dBFS, 9.8 MHz @ -7 dBFS	25°C		96			95		dBFS
$f_{IN} = 70.3$ MHz @ -7 dBFS, 69.3 MHz @ -7 dBFS	25°C		92			92		dBFS
ANALOG BANDWIDTH	Full		325			540		MHz

AD9446

DIGITAL SPECIFICATIONS

AVDD1 = 3.3 V, AVDD2 = 5.0 V, DRVDD = 3.3 V, R_{LVDS_BIAS} = 3.74 kΩ, unless otherwise noted.

Table 3.

Parameter	Temp	AD9446BSVZ-80			AD9446BSVZ-100			Unit
		Min	Typ	Max	Min	Typ	Max	
CMOS LOGIC INPUTS (DFS, DCS MODE, OUTPUT MODE)								
High Level Input Voltage	Full	2.0			2.0			V
Low Level Input Voltage	Full			0.8			0.8	V
High Level Input Current	Full			200			200	μA
Low Level Input Current	Full	-10		+10	-10		+10	μA
Input Capacitance	Full		2			2		pF
DIGITAL OUTPUT BITS—CMOS MODE (D0 to D15, OTR) ¹								
DRVDD = 3.3 V								
High Level Output Voltage	Full	3.25			3.25			V
Low Level Output Voltage	Full			0.2			0.2	V
DIGITAL OUTPUT BITS—LVDS MODE (D0 to D15, OTR)								
V _{OD} Differential Output Voltage ²	Full	247		545	247		545	mV
V _{OS} Output Offset Voltage	Full	1.125		1.375	1.125		1.375	V
CLOCK INPUTS (CLK+, CLK-)								
Differential Input Voltage	Full	0.2			0.2			V
Common-Mode Voltage	Full	1.3	1.5	1.6	1.3	1.5	1.6	V
Input Resistance	Full	1.1	1.4	1.7	1.1	1.4	1.7	kΩ
Input Capacitance	Full		2			2		pF

¹ Output voltage levels measured with 5 pF load on each output.

² LVDS R_{TERM} = 100 Ω.

SWITCHING SPECIFICATIONS

AVDD1 = 3.3 V, AVDD2 = 5.0 V, DRVDD = 3.3 V, unless otherwise noted.

Table 4.

Parameter	Temp	AD9446BSVZ-80			AD9446BSVZ-100			Unit
		Min	Typ	Max	Min	Typ	Max	
CLOCK INPUT PARAMETERS								
Maximum Conversion Rate	Full	80			100			MSPS
Minimum Conversion Rate	Full			1			1	MSPS
CLK Period	Full	12.5			10			ns
CLK Pulse Width High ¹ (t _{CLKH})	Full	5.0			4.0			ns
CLK Pulse Width Low ¹ (t _{CLKL})	Full	5.0			4.0			ns
DATA OUTPUT PARAMETERS								
Output Propagation Delay—CMOS (t _{PD}) ² (DX, DCO+)	Full		3.35			3.35		ns
Output Propagation Delay—LVDS (t _{PD}) ³ (DX+), (t _{CPD}) ³ (DCO+)	Full	2.1	3.6	4.8	2.3	3.6	4.8	ns
Pipeline Delay (Latency)	Full		13			13		Cycles
Aperture Delay (t _A)	Full							ns
Aperture Uncertainty (Jitter, t _J)	Full		60			60		fsec rms

¹ With duty cycle stabilizer (DCS) enabled.

² Output propagation delay is measured from clock 50% transition to data 50% transition with 5 pF load.

³ LVDS R_{TERM} = 100 Ω. Measured from the 50% point of the rising edge of CLK+ to the 50% point of the data transition.

TIMING DIAGRAMS

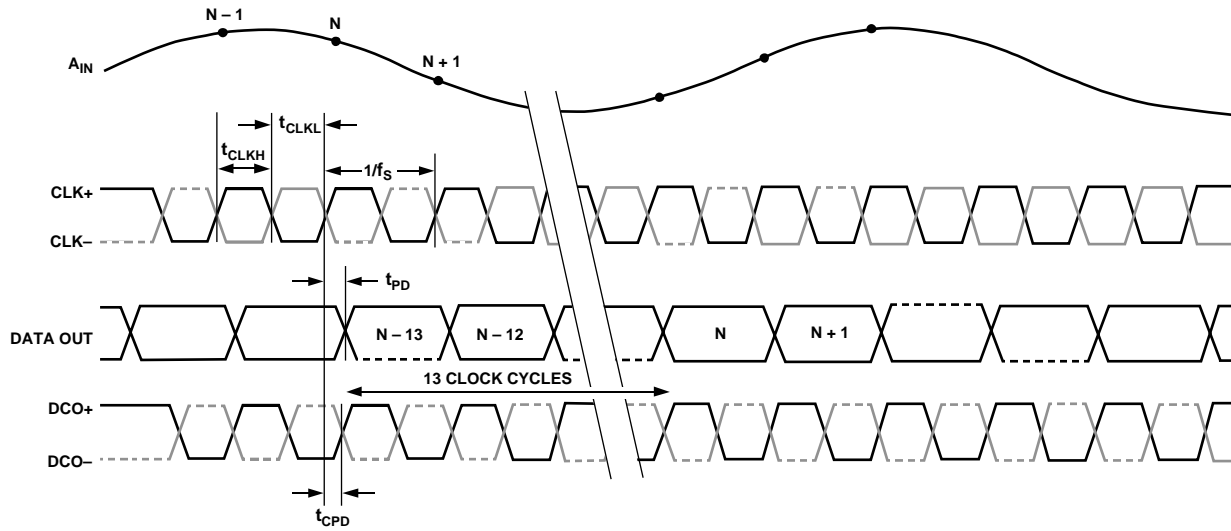

05490-002

Figure 2. LVDS Mode Timing Diagram

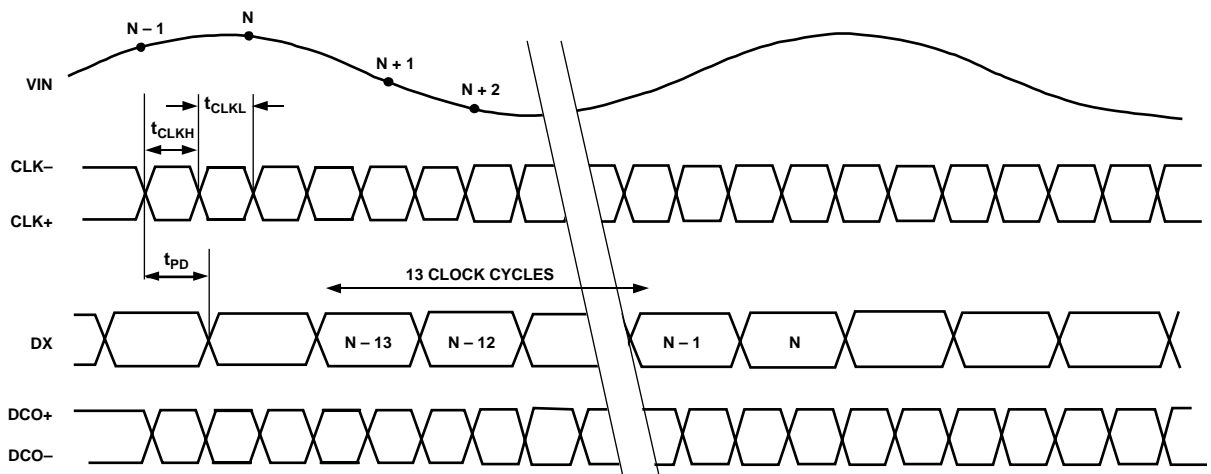

05490-003

Figure 3. CMOS Timing Diagram

ABSOLUTE MAXIMUM RATINGS

Table 5.

Parameter	With Respect to	Rating
ELECTRICAL		
AVDD1	AGND	-0.3 V to +4 V
AVDD2	AGND	-0.3 V to +6 V
DRVDD	DGND	-0.3 V to +4 V
AGND	DGND	-0.3 V to +0.3 V
AVDD1	DRVDD	-4 V to +4 V
AVDD2	DRVDD	-4 V to +6 V
AVDD2	AVDD1	-4 V to +6 V
D0± to D15±	DGND	-0.3 V to DRVDD + 0.3 V
CLK+/CLK-	AGND	-0.3 V to AVDD1 + 0.3 V
OUTPUT MODE, DCS MODE, DFS	AGND	-0.3 V to AVDD1 + 0.3 V
VIN+, VIN-	AGND	-0.3 V to AVDD2 + 0.3 V
VREF	AGND	-0.3 V to AVDD1 + 0.3 V
SENSE	AGND	-0.3 V to AVDD1 + 0.3 V
REFT, REFB	AGND	-0.3 V to AVDD1 + 0.3 V
ENVIRONMENTAL		
Storage Temperature Range		-65°C to +125°C
Operating Temperature Range		-40°C to +85°C
Lead Temperature (Soldering 10 sec)		300°C
Junction Temperature		150°C

Stresses above those listed under Absolute Maximum Ratings may cause permanent damage to the device. This is a stress rating only; functional operation of the device at these or any other conditions above those indicated in the operational section of this specification is not implied. Exposure to absolute maximum rating conditions for extended periods may affect device reliability.

THERMAL RESISTANCE

The heat sink of the AD9446 package must be soldered to ground.

Table 6.

Package Type	θ_{JA}	θ_{JB}	θ_{JC}	Unit
100-lead TQFP/EP	19.8	8.3	2	°C/W

Typical θ_{JA} = 19.8°C/W (heat sink soldered) for multilayer board in still air.

Typical θ_{JB} = 8.3°C/W (heat sink soldered) for multilayer board in still air.

Typical θ_{JC} = 2°C/W (junction to exposed heat sink) represents the thermal resistance through heat sink path.

Airflow increases heat dissipation, effectively reducing θ_{JA} . Also, more metal directly in contact with the package leads from metal traces through holes, ground, and power planes reduces the θ_{JA} . It is required that the exposed heat sink be soldered to the ground plane.

ESD CAUTION

ESD (electrostatic discharge) sensitive device. Electrostatic charges as high as 4000 V readily accumulate on the human body and test equipment and can discharge without detection. Although this product features proprietary ESD protection circuitry, permanent damage may occur on devices subjected to high energy electrostatic discharges. Therefore, proper ESD precautions are recommended to avoid performance degradation or loss of functionality.



TERMINOLOGY

Analog Bandwidth (Full Power Bandwidth)

The analog input frequency at which the spectral power of the fundamental frequency (as determined by the FFT analysis) is reduced by 3 dB.

Aperture Delay (t_A)

The delay between the 50% point of the rising edge of the clock and the instant at which the analog input is sampled.

Aperture Uncertainty (Jitter, t_j)

The sample-to-sample variation in aperture delay.

Clock Pulse Width and Duty Cycle

Pulse width high is the minimum amount of time that the clock pulse should be left in the Logic 1 state to achieve rated performance. Pulse width low is the minimum time the clock pulse should be left in the low state. At a given clock rate, these specifications define an acceptable clock duty cycle.

Differential Nonlinearity (DNL, No Missing Codes)

An ideal ADC exhibits code transitions that are exactly 1 LSB apart. DNL is the deviation from this ideal value. Guaranteed no missing codes to 16-bit resolution indicates that all 65,536 codes must be present over all operating ranges.

Effective Number of Bits (ENOB)

The effective number of bits for a sine wave input at a given input frequency can be calculated directly from its measured SINAD using the following formula:

$$ENOB = \frac{(SINAD - 1.76)}{6.02}$$

Gain Error

The first code transition should occur at an analog value of $\frac{1}{2}$ LSB above negative full scale. The last transition should occur at an analog value of $1\frac{1}{2}$ LSB below the positive full scale. Gain error is the deviation of the actual difference between first and last code transitions and the ideal difference between first and last code transitions.

Integral Nonlinearity (INL)

The deviation of each individual code from a line drawn from negative full scale through positive full scale. The point used as negative full scale occurs $\frac{1}{2}$ LSB before the first code transition. Positive full scale is defined as a level $1\frac{1}{2}$ LSB beyond the last code transition. The deviation is measured from the middle of each particular code to the true straight line.

Maximum Conversion Rate

The clock rate at which parametric testing is performed.

Minimum Conversion Rate

The clock rate at which the SNR of the lowest analog signal frequency drops by no more than 3 dB below the guaranteed limit.

Offset Error

The major carry transition should occur for an analog value of $\frac{1}{2}$ LSB below $V_{IN+} = V_{IN-}$. Offset error is defined as the deviation of the actual transition from that point.

Out-of-Range Recovery Time

The time it takes for the ADC to reacquire the analog input after a transition from 10% above positive full scale to 10% above negative full scale, or from 10% below negative full scale to 10% below positive full scale.

Output Propagation Delay (t_{PD})

The delay between the clock rising edge and the time when all bits are within valid logic levels.

Power-Supply Rejection Ratio

The change in full scale from the value with the supply at the minimum limit to the value with the supply at the maximum limit.

Signal-to-Noise and Distortion (SINAD)

The ratio of the rms input signal amplitude to the rms value of the sum of all other spectral components below the Nyquist frequency, including harmonics but excluding dc.

Signal-to-Noise Ratio (SNR)

The ratio of the rms input signal amplitude to the rms value of the sum of all other spectral components below the Nyquist frequency, excluding the first six harmonics and dc.

Spurious-Free Dynamic Range (SFDR)

The ratio of the rms signal amplitude to the rms value of the peak spurious spectral component. The peak spurious component may be a harmonic. SFDR can be reported in dBc (that is, degrades as signal level is lowered) or dBFS (always related back to converter full scale).

Temperature Drift

The temperature drift for offset error and gain error specifies the maximum change from the initial (25°C) value to the value at T_{MIN} or T_{MAX} .

Total Harmonic Distortion (THD)

The ratio of the rms input signal amplitude to the rms value of the sum of the first six harmonic components.

Two-Tone SFDR

The ratio of the rms value of either input tone to the rms value of the peak spurious component. The peak spurious component may or may not be an IMD product.

PIN CONFIGURATIONS AND FUNCTION DESCRIPTIONS

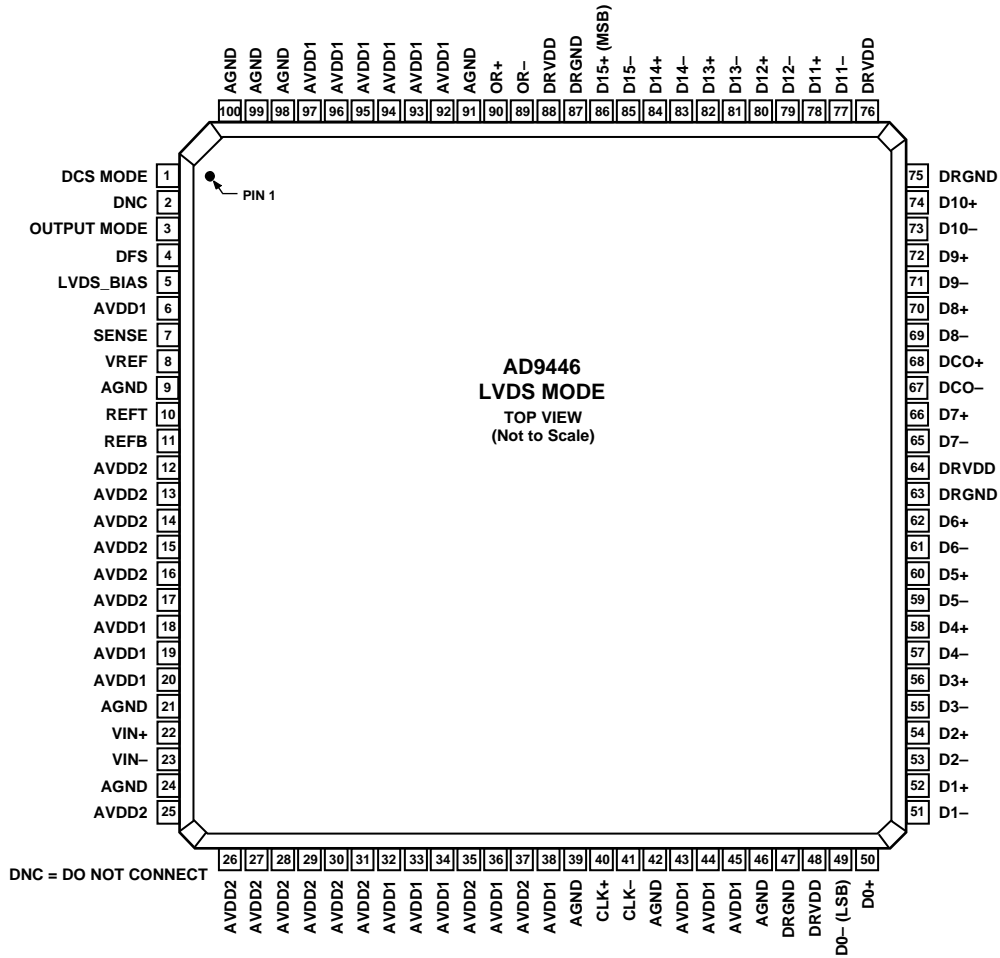

Figure 4. 100-Lead TQFP/EP Pin Configuration in LVDS Mode

05490-004

Table 7. Pin Function Descriptions—100-Lead TQFP/EP in LVDS Mode

Pin No.	Mnemonic	Description
1	DCS MODE	Clock Duty Cycle Stabilizer (DCS) Control Pin. CMOS compatible. DCS = low (AGND) to enable DCS (recommended); DCS = high (AVDD1) to disable DCS.
2	DNC	Do Not Connect. These pins should float.
3	OUTPUT MODE	CMOS-Compatible Output Logic Mode Control Pin. OUTPUT MODE = 0 for CMOS mode; OUTPUT MODE = 1 (AVDD1) for LVDS outputs.
4	DFS	Data Format Select Pin. CMOS control pin that determines the format of the output data. DFS = high (AVDD1) for twos complement; DFS = low (ground) for offset binary format.
5	LVDS_BIAS	Set Pin for LVDS Output Current. Place 3.7 k Ω resistor terminated to DRGND.
6, 18 to 20, 32 to 34, 36, 38, 43 to 45, 92 to 97	AVDD1	3.3 V ($\pm 5\%$) Analog Supply.
7	SENSE	Reference Mode Selection. Connect to AGND for internal 1.6 V reference (3.2 V p-p analog input range); connect to AVDD1 for external reference.
8	VREF	1.6 V Reference I/O. Function dependent on SENSE and external programming resistors. Decouple to ground with 0.1 μ F and 10 μ F capacitors.
9, 21, 24, 39, 42, 46, 91, 98, 99, 100, Exposed Heat Sink	AGND	Analog Ground. The exposed heat sink on the bottom of the package must be connected to AGND.
10	REFT	Differential Reference Output. Decoupled to ground with 0.1 μ F capacitor and to REFB (Pin 11) with 0.1 μ F and 10 μ F capacitors.
11	REFB	Differential Reference Output. Decoupled to ground with a 0.1 μ F capacitor and to REFT (Pin 10) with 0.1 μ F and 10 μ F capacitors.
12 to 17, 25 to 31, 35, 37	AVDD2	5.0 V Analog Supply ($\pm 5\%$).
22	VIN+	Analog Input—True.
23	VIN-	Analog Input—Complement.
40	CLK+	Clock Input—True.
41	CLK-	Clock Input—Complement.
47, 63, 75, 87,	DRGND	Digital Output Ground.
48, 64, 76, 88	DRVDD	3.3 V Digital Output Supply (3.0 V to 3.6 V).
49	D0- (LSB)	D0 Complement Output Bit (LVDS Levels).
50	D0+	D0 True Output Bit.
51	D1-	D1 Complement Output Bit.
52	D1+	D1 True Output Bit.
53	D2-	D2 Complement Output Bit.
54	D2+	D2 True Output Bit.
55	D3-	D3 Complement Output Bit.
56	D3+	D3 True Output Bit.
57	D4-	D4 Complement Output Bit.
58	D4+	D4 True Output Bit.
59	D5-	D5 Complement Output Bit.
60	D5+	D5 True Output Bit.
61	D6-	D6 Complement Output Bit.
62	D6+	D6 True Output Bit.
65	D7-	D7 Complement Output Bit.
66	D7+	D7 True Output Bit.
67	DCO-	Data Clock Output—Complement.
68	DCO+	Data Clock Output—True.
69	D8-	D8 Complement Output Bit.
70	D8+	D8 True Output Bit.
71	D9-	D9 Complement Output Bit.
72	D9+	D9 True Output Bit.
73	D10-	D10 Complement Output Bit.
74	D10+	D10 True Output Bit.
77	D11-	D11 Complement Output Bit.
78	D11+	D11 True Output Bit.

AD9446

Pin No.	Mnemonic	Description
79	D12-	D12 Complement Output Bit.
80	D12+	D12 True Output Bit.
81	D13-	D13 Complement Output Bit
82	D13+	D13 True Output Bit.
83	D14-	D14 Complement Output Bit
84	D14+	D14 True Output Bit.
85	D15-	D15 Complement Output Bit.
86	D15+ (MSB)	D15 True Output Bit.
89	OR-	Out-of-Range Complement Output Bit.
90	OR+	Out-of-Range True Output Bit.

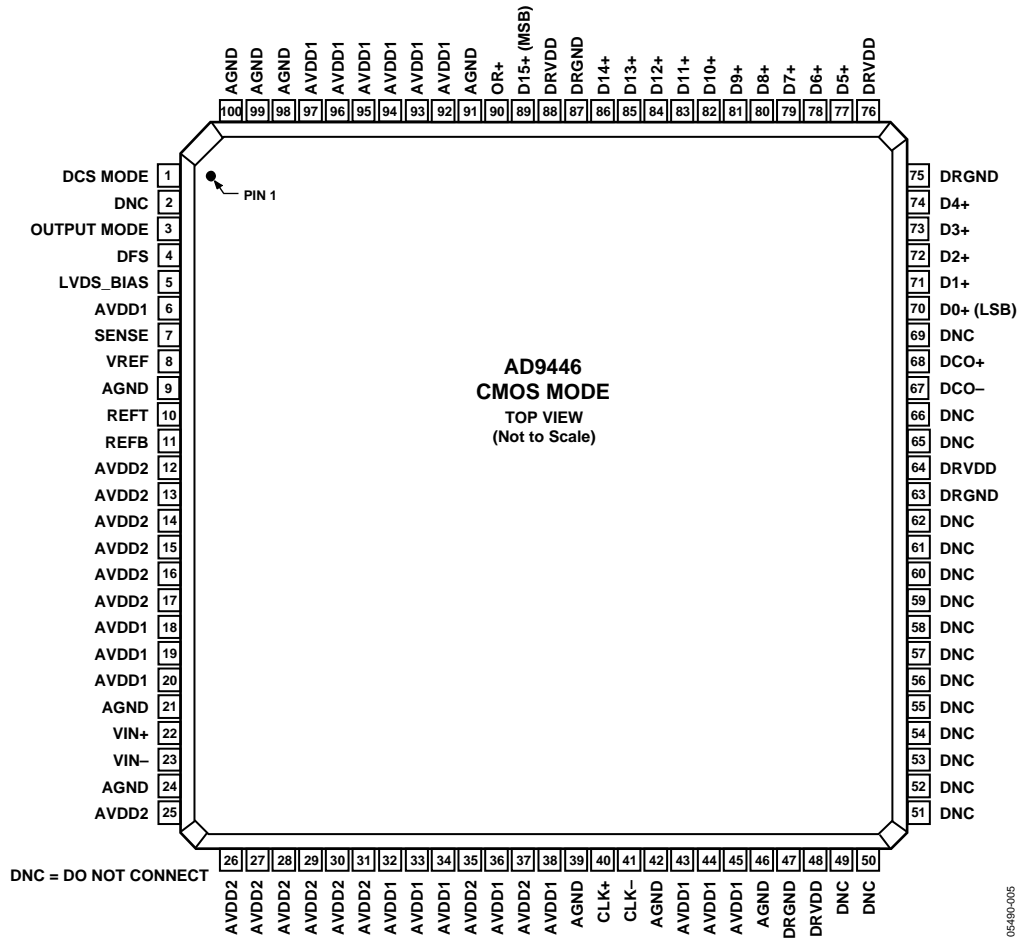

Figure 5. 100-Lead TQFP/EP Pin Configuration in CMOS Mode

05490-005

Table 8. Pin Function Descriptions—100-Lead TQFP/EP in CMOS Mode

Pin No.	Mnemonic	Description
1	DCS MODE	Clock Duty Cycle Stabilizer (DCS) Control Pin. CMOS compatible. DCS = low (AGND) to enable DCS (recommended); DCS = high (AVDD1) to disable DCS.
2, 49 to 62, 65 to 66, 69, 3	DNC OUTPUT MODE	Do Not Connect. These pins should float. CMOS-Compatible Output Logic Mode Control Pin. OUTPUT MODE = 0 for CMOS mode; OUTPUT MODE = 1 (AVDD1) for LVDS outputs.
4	DFS	Data Format Select Pin. CMOS control pin that determines the format of the output data. DFS = high (AVDD1) for twos complement; DFS = low (ground) for offset binary format.
5	LVDS_BIAS	Set Pin for LVDS Output Current. Place 3.7 k Ω resistor terminated to DRGND.
6, 18 to 20, 32 to 34, 36, 38, 43 to 45, 92 to 97	AVDD1	3.3 V ($\pm 5\%$) Analog Supply.
7	SENSE	Reference Mode Selection. Connect to AGND for internal 1 V reference; connect to AVDD1 for external reference.
8	VREF	1.6 V Reference I/O. Function dependent on SENSE and external programming resistors. Decouple to ground with 0.1 μ F and 10 μ F capacitors.
9, 21, 24, 39, 42, 46, 91, 98, 99, 100, Exposed Heat Sink	AGND	Analog Ground. The exposed heat sink on the bottom of the package must be connected to AGND.
10	REFT	Differential Reference Output. Decoupled to ground with 0.1 μ F capacitor and to REFB (Pin 11) with 0.1 μ F and 10 μ F capacitors.
11	REFB	Differential Reference Output. Decoupled to ground with a 0.1 μ F capacitor and to REFT (Pin 10) with 0.1 μ F and 10 μ F capacitors.
12 to 17, 25 to 31, 35, 37	AVDD2	5.0 V Analog Supply ($\pm 5\%$).
22	VIN+	Analog Input—True.
23	VIN-	Analog Input—Complement.
40	CLK+	Clock Input—True.
41	CLK-	Clock Input—Complement.
47, 63, 75, 87,	DRGND	Digital Output Ground.
48, 64, 76, 88	DRVDD	3.3 V Digital Output Supply (3.0 V to 3.6 V).
67	DCO-	Data Clock Output—Complement.
68	DCO+	Data Clock Output—True.
70	D0+ (LSB)	D0 True Output Bit (CMOS levels).
71	D1+	D1 True Output Bit.
72	D2+	D2 True Output Bit.
73	D3+	D3 True Output Bit.
74	D4+	D4 True Output Bit.
77	D5+	D5 True Output Bit.
78	D6+	D6 True Output Bit.
79	D7+	D7 True Output Bit.
80	D8+	D8 True Output Bit.
81	D9+	D9 True Output Bit.
82	D10+	D10 True Output Bit.
83	D11+	D11 True Output Bit.
84	D12+	D12 True Output Bit.
85	D13+	D13 True Output Bit.
86	D14+	D14 True Output Bit.
89	D15+ (MSB)	D15 True Output Bit.
90	OR+	Out-of-Range True Output Bit.

EQUIVALENT CIRCUITS

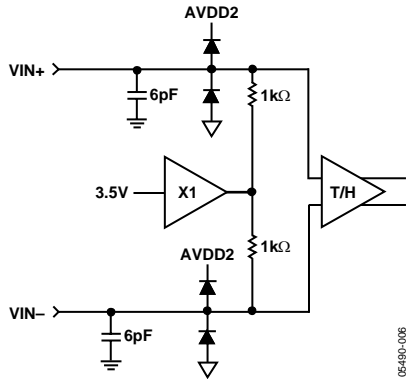

Figure 6. Equivalent Analog Input Circuit

05490-006

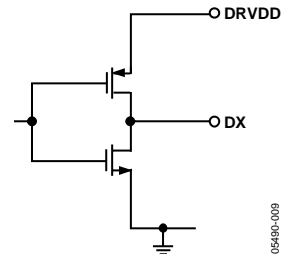

Figure 9. Equivalent CMOS Digital Output Circuit

05490-008

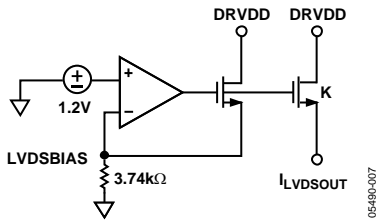

Figure 7. Equivalent LVDS_BIAS Circuit

05490-007

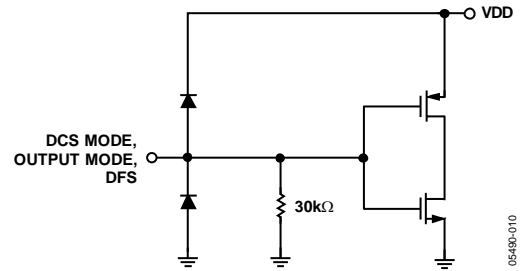

Figure 10. Equivalent Digital Input Circuit, DFS, DCS MODE, OUTPUT MODE

05490-010

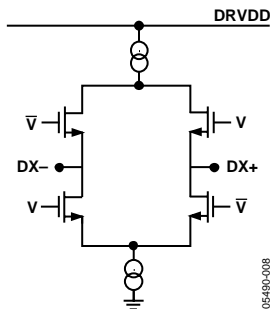

Figure 8. Equivalent LVDS Digital Output Circuit

05490-008

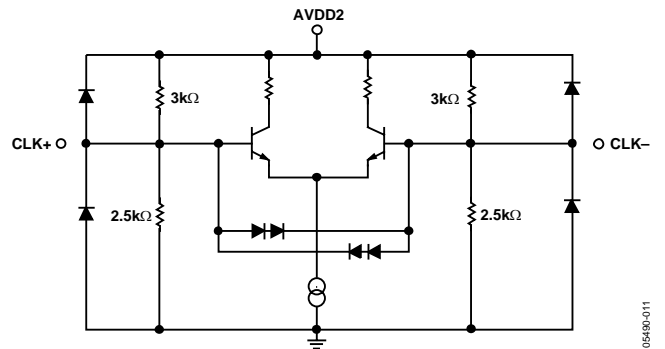

Figure 11. Equivalent Sample Clock Input Circuit

05490-011

TYPICAL PERFORMANCE CHARACTERISTICS

AVDD1 = 3.3 V, AVDD2 = 5.0 V, DRVDD = 3.3 V, rated sample rate, LVDS mode, DCS enabled, $T_A = 25^\circ\text{C}$, 3.2 V p-p differential input, AIN = -1dBFS, internal trimmed reference (nominal VREF = 1.6 V), unless otherwise noted.

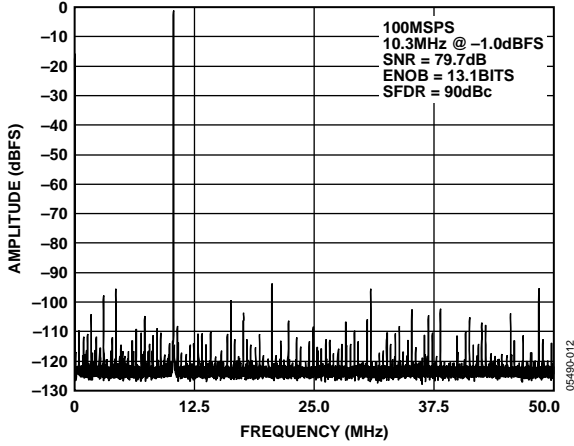

Figure 12. AD9446-100 64k Point Single-Tone FFT/100 MSPS/10.3 MHz

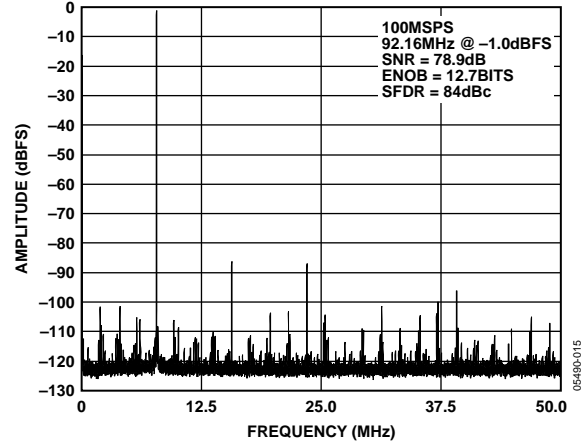

Figure 15. AD9446-100 64k Point Single-Tone FFT/100 MSPS/92.16 MHz

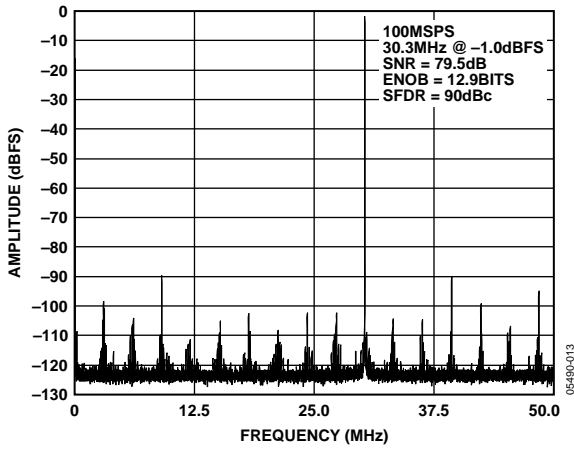

Figure 13. AD9446-100 64k Point Single-Tone FFT/100 MSPS/30.3 MHz

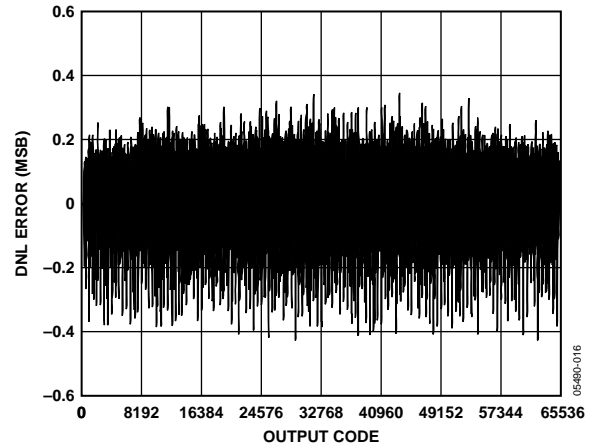

Figure 16. AD9446-100 DNL Error vs. Output Code, 100 MSPS, 10.3 MHz

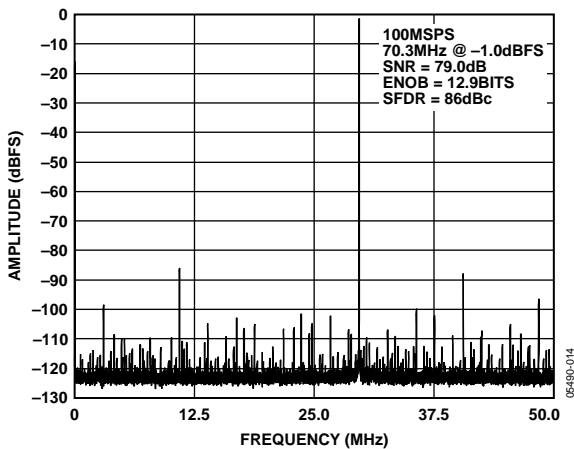

Figure 14. AD9446-100 64k Point Single-Tone FFT/100 MSPS/70.3 MHz

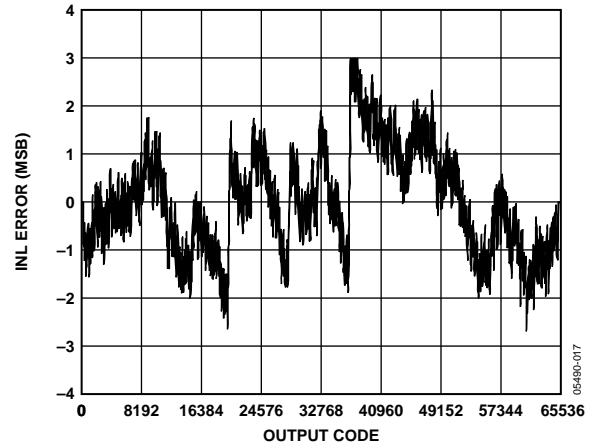

Figure 17. AD9446-100 INL Error vs. Output Code, 100 MSPS, 10.3 MHz

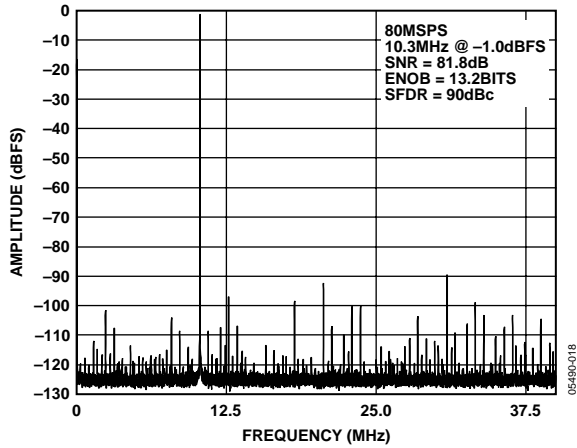

Figure 18. AD9446-80 64k Point Single-Tone FFT/80 MSPS/10.3 MHz

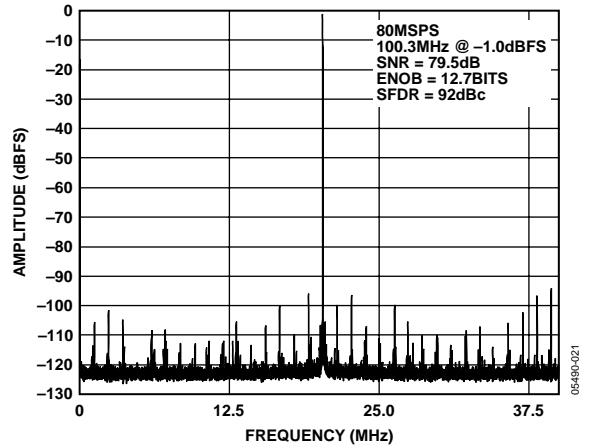

Figure 21. AD9446-80 64k Point Single-Tone FFT/80 MSPS/100.3 MHz

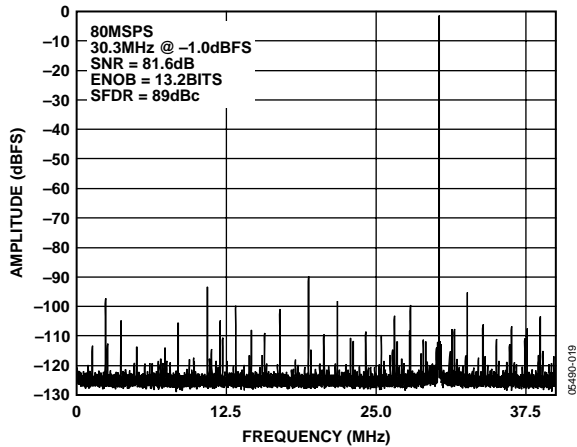

Figure 19. AD9446-80 64k Point Single-Tone FFT/80 MSPS/30.3 MHz

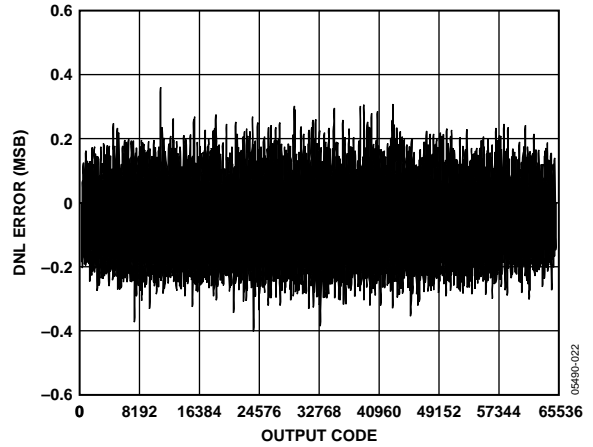

Figure 22. AD9446-80 DNL Error vs. Output Code, 80 MSPS, 10.3 MHz

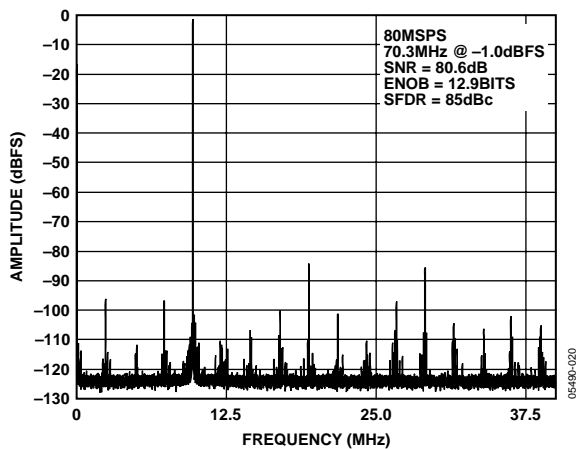

Figure 20. AD9446-80 64k Point Single-Tone FFT/80 MSPS/70.3 MHz

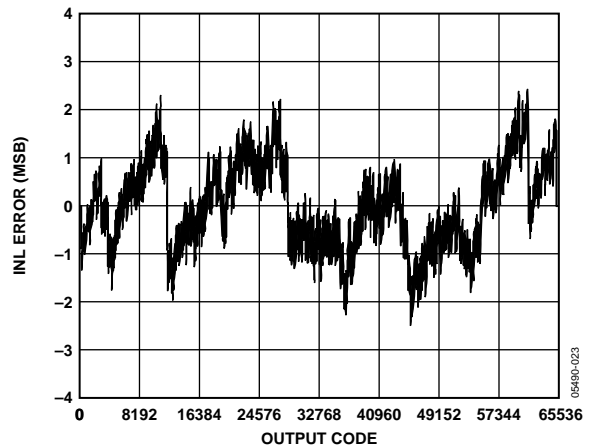

Figure 23. AD9446-80 INL Error vs. Output Code, 80 MSPS, 10.3 MHz

AD9446

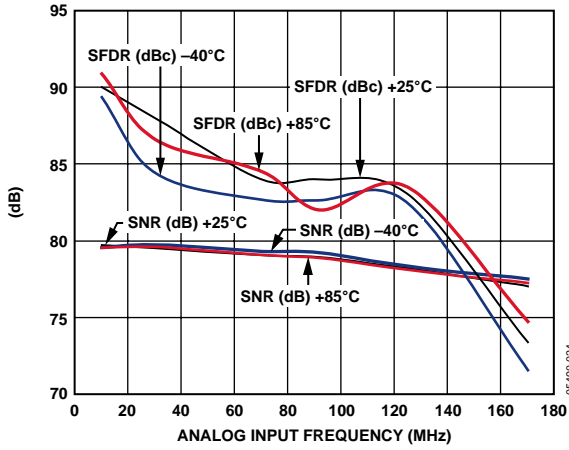

Figure 24. AD9446-100 SNR/SFDR vs. Analog Input Frequency, 100 MSPS, 3.2 V p-p

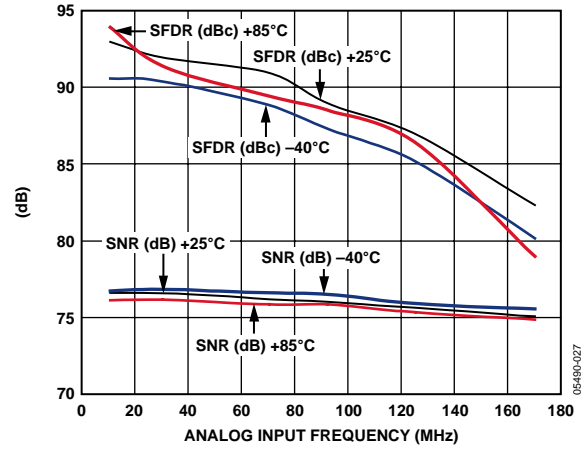

Figure 27. AD9446-100 SNR/SFDR vs. Analog Input Frequency, 100 MSPS, 2.0 V p-p

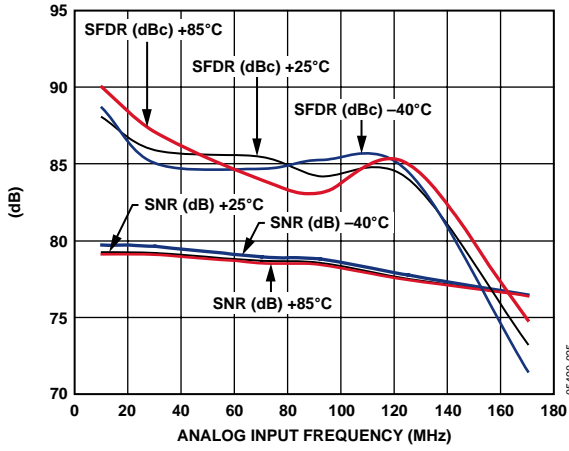

Figure 25. AD9446-100 SNR/SFDR vs. Analog Input Frequency, 100 MSPS, 3.2 V p-p, CMOS Output Mode

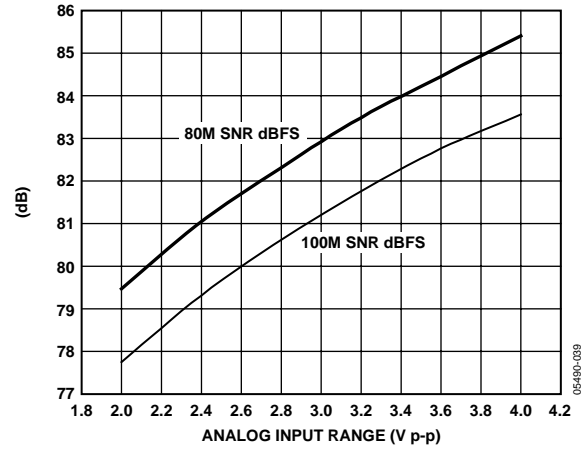

Figure 28. AD9446-100 SNR vs. Input Range, 30.3 MHz, -30 dBFS

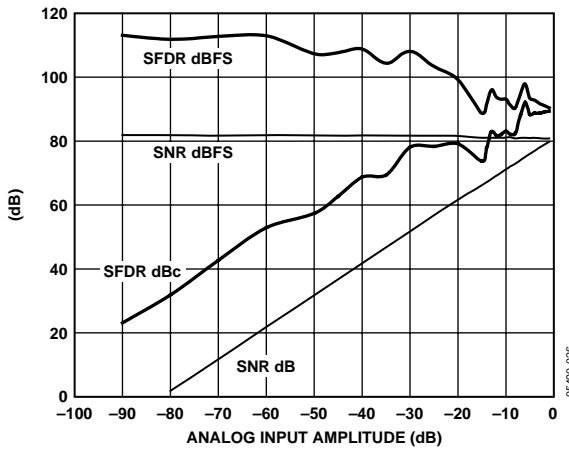

Figure 26. AD9446-100 SNR/SFDR vs. Analog Input Level, 100 MSPS

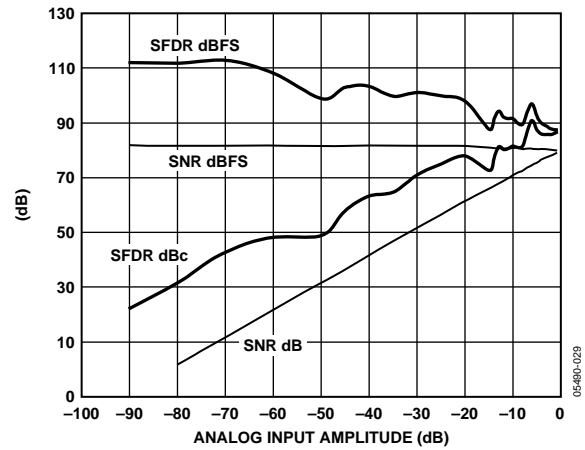

Figure 29. AD9446-100 SNR/SFDR vs. Analog Input Level, 100 MSPS, CMOS Output Mode

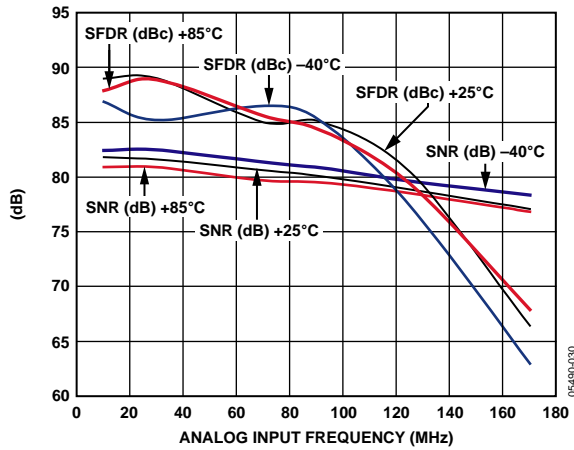

Figure 30. AD9446-80 SNR/SFDR vs. Analog Input Frequency, 80 MSPS, 3.2 V_{p-p}

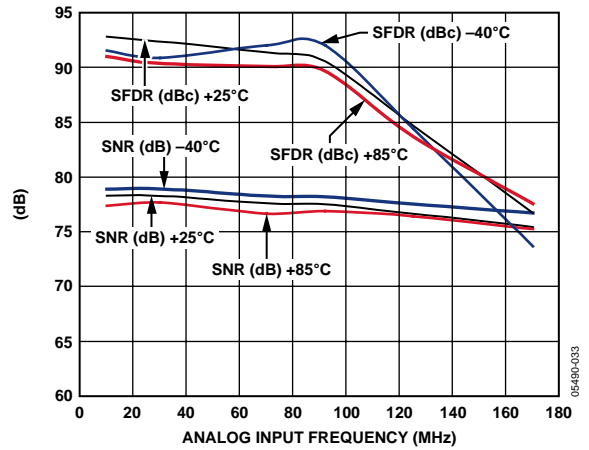

Figure 33. AD9446-80 SNR/SFDR vs. Analog Input Frequency, 80 MSPS, 2.0 V_{p-p}

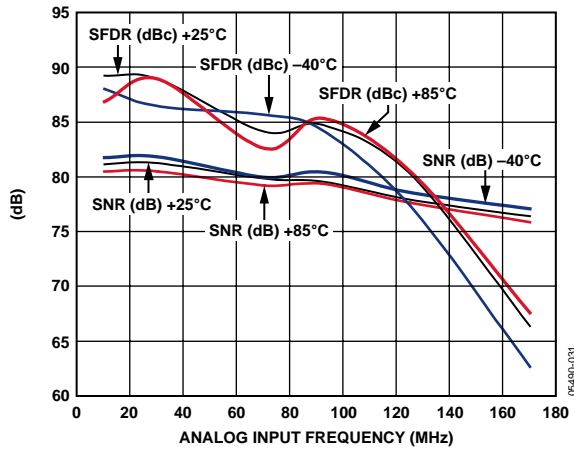

Figure 31. AD9446-80 SNR/SFDR vs. Analog Input Frequency, 80 MSPS, 3.2 V_{p-p}, CMOS Mode

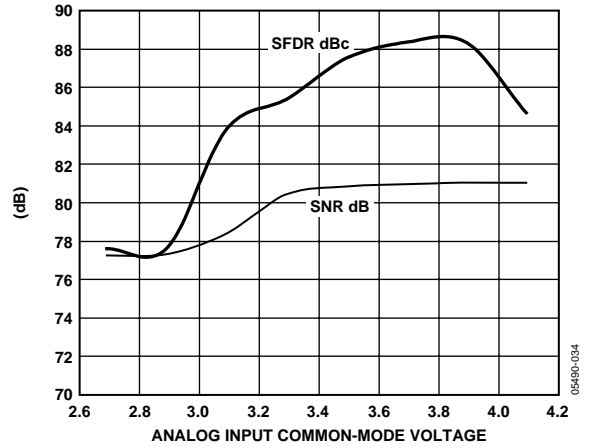

Figure 34. AD9446-80 SNR/SFDR vs. Analog Input Common Mode, 80 MSPS

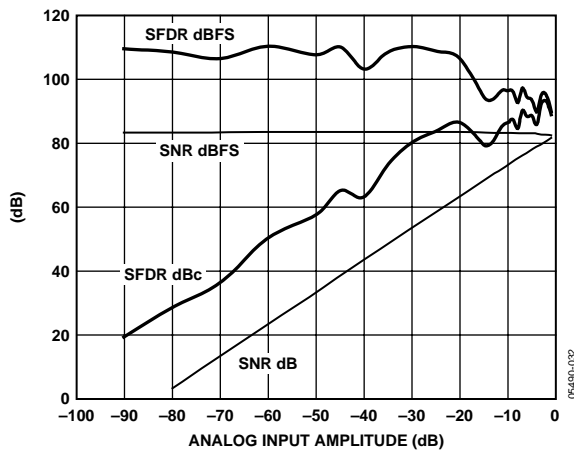

Figure 32. AD9446-80 SNR/SFDR vs. Analog Input Level, 80 MSPS

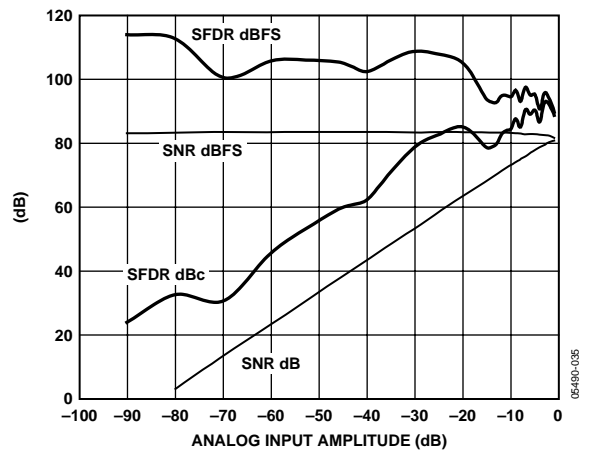

Figure 35. AD9446-80 SNR/SFDR vs. Analog Input Level, 80 MSPS, CMOS Output Mode

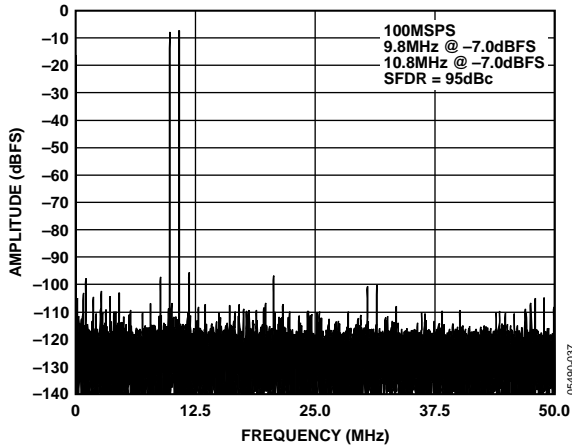

Figure 36. AD9446-100 64k Point Two-Tone FFT/100 MSPS/9.8 MHz, 10.8 MHz

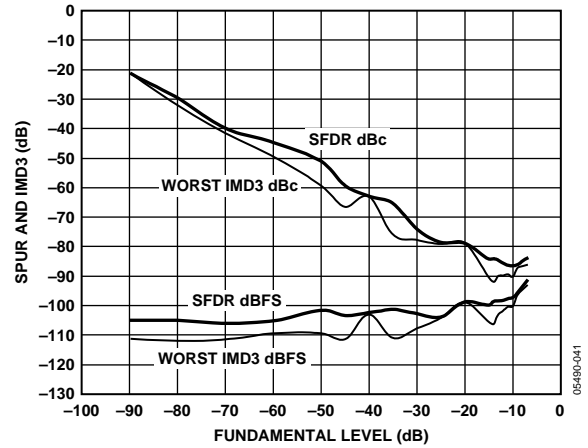

Figure 39. AD9446-100 Two-Tone SFDR vs. Analog Input Level 100 MSPS/69.3 MHz, 70.3 MHz

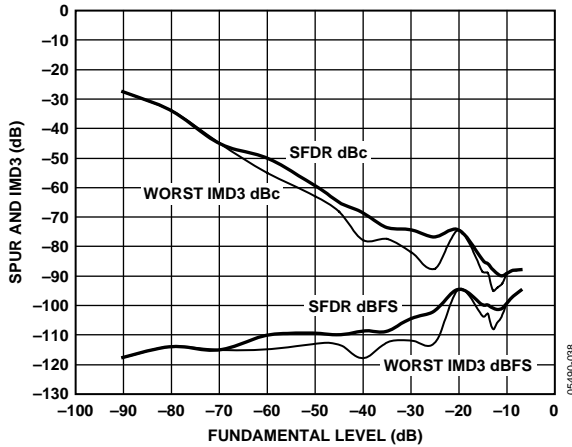

Figure 37. AD9446-100 Two-Tone SFDR vs. Analog Input Level 100 MSPS/9.8 MHz, 10.8 MHz

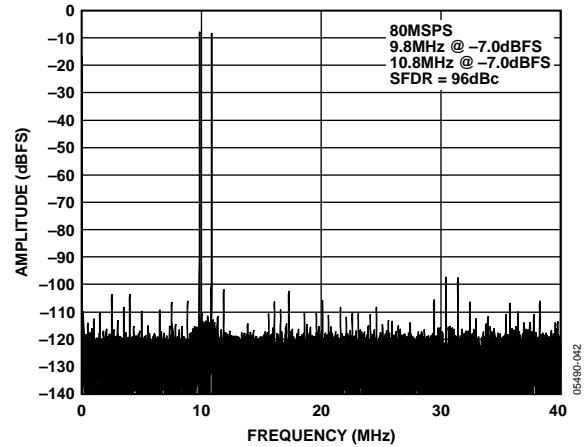

Figure 40. AD9446-80 64k Point Two-Tone FFT/80 MSPS/9.8 MHz, 10.8 MHz

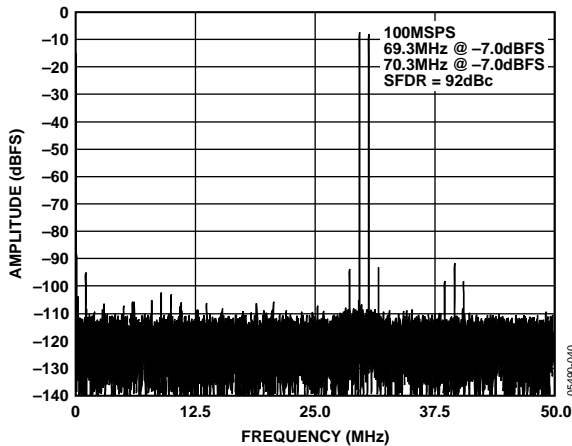

Figure 38. AD9446-100 64k Point Two-Tone FFT/100 MSPS/69.3 MHz, 70.3 MHz

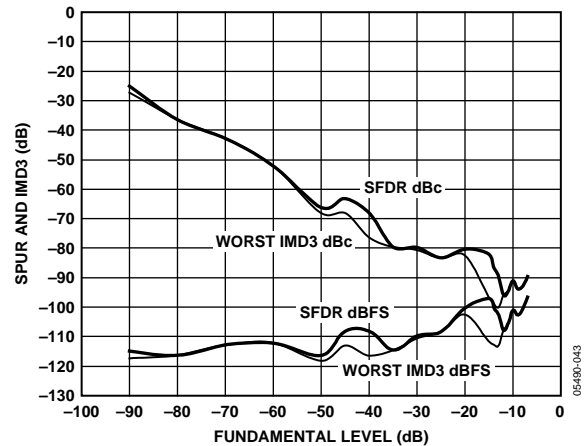

Figure 41. AD9446-80 Two-Tone SFDR vs. Analog Input Level 80 MSPS/9.8 MHz, 10.8 MHz

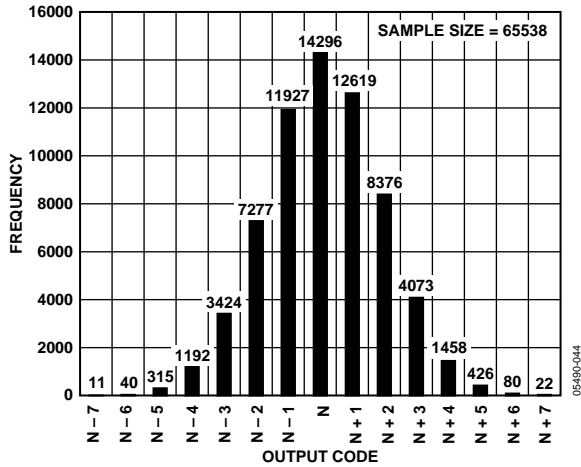

Figure 42. AD9446-100 Grounded Input Histogram

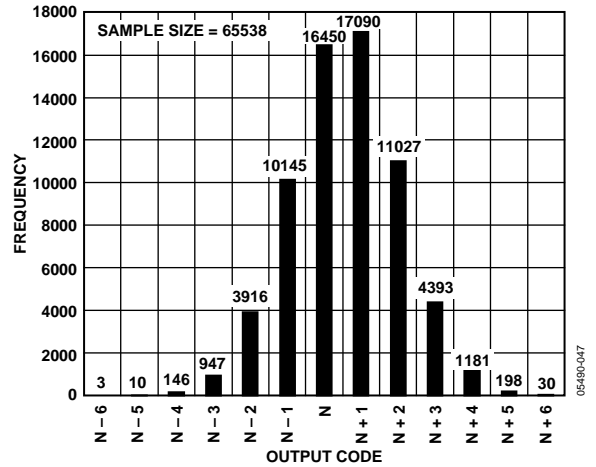

Figure 45. AD9446-80 Grounded Input Histogram

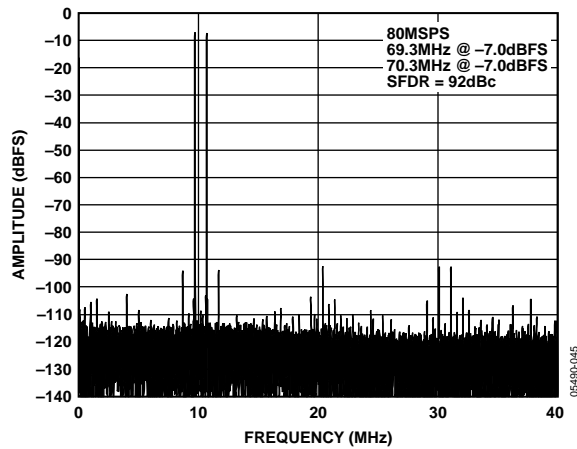

Figure 43. AD9446-80 64k Point Two-Tone FFT/80 MSPS/69.3 MHz, 70.3 MHz

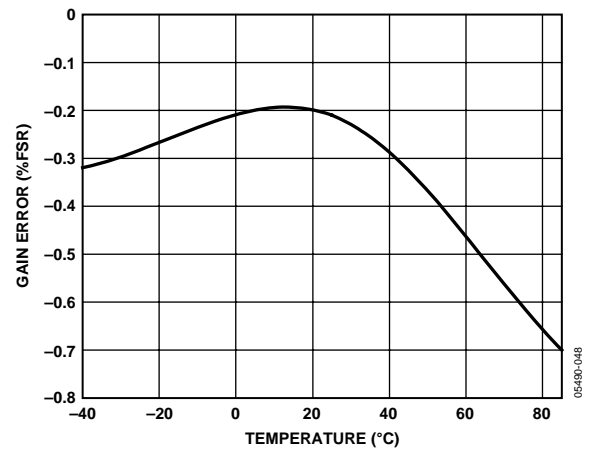

Figure 46. AD9446-100 Gain vs. Temperature

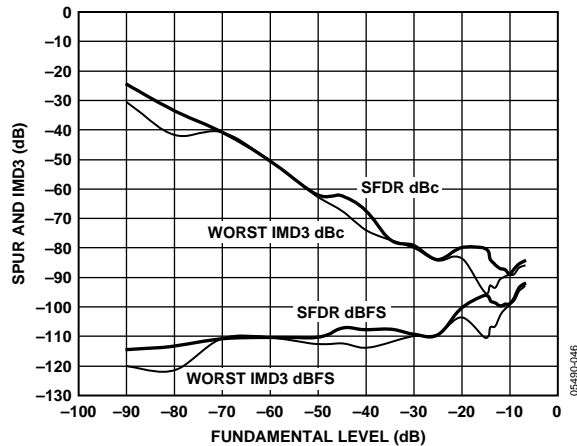

Figure 44. AD9446-80 Two-Tone SFDR vs. Analog Input Level 80 MSPS/69.3 MHz, 70.3 MHz

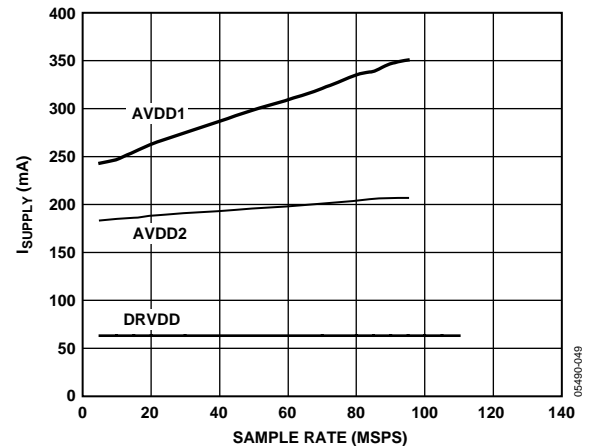

Figure 47. AD9446-80 Power Supply Current vs. Sample Rate 10.3 MHz @ -1 dBFS

AD9446

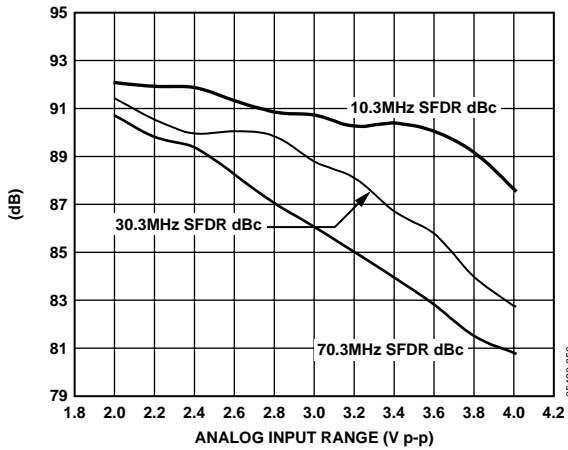

Figure 48. AD9446-100/SFDR vs. Analog Input Range, 100 MSPS

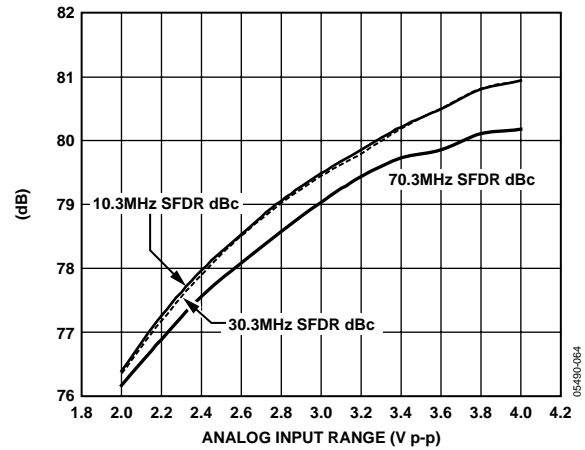

Figure 51. AD9446-100 SNR vs. Analog Input Range, 100 MSPS

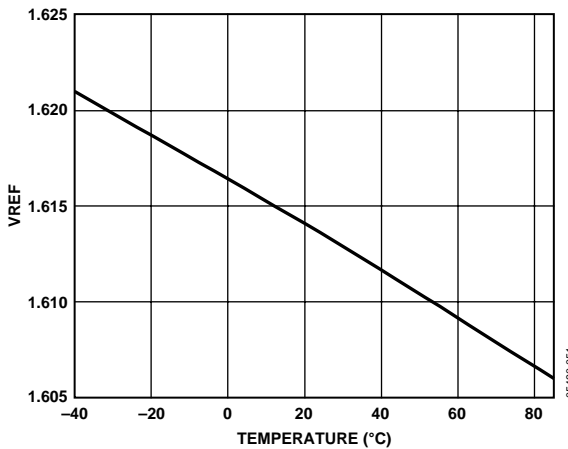

Figure 49. AD9446-100 VREF vs. Temperature

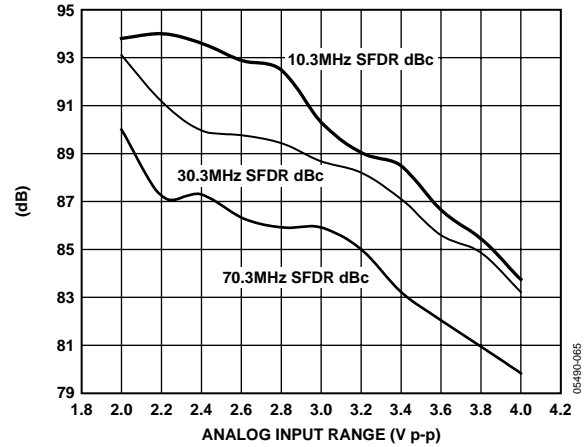

Figure 52. AD9446-80 SFDR vs. Analog Input Range, 100 MSPS

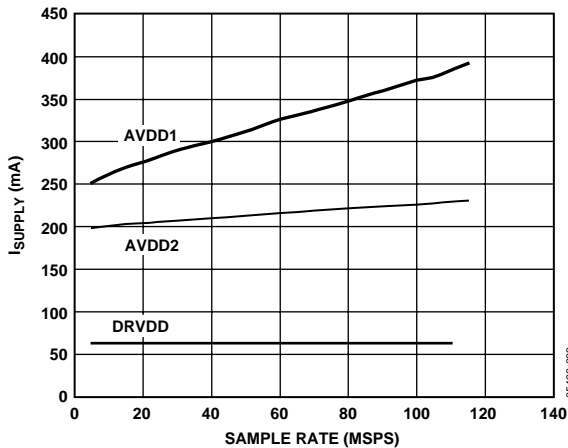

Figure 50. AD9446-100 Power Supply Current vs. Sample Rate, 10.3 MHz @ -1 dBFS

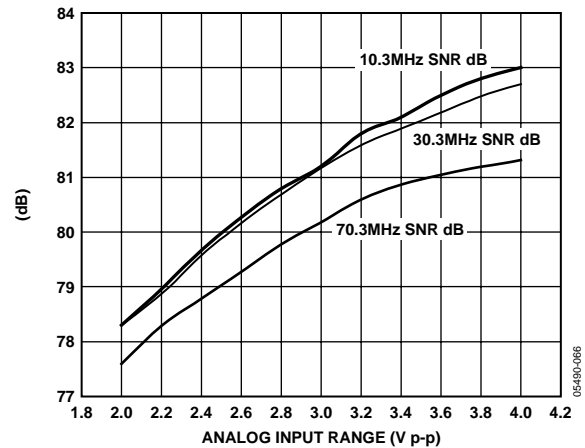

Figure 53. AD9446-80/SNR vs. Analog Input Range, 80 MSPS

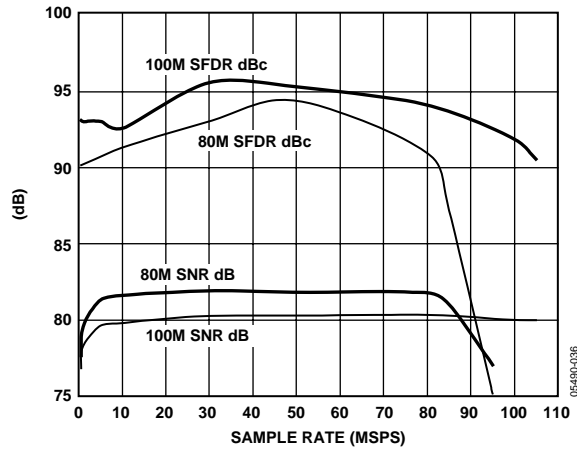

Figure 54. AD9446 Single-Tone SNR/SFDR vs. Sample Rate 2.3 MHz

THEORY OF OPERATION

The AD9446 architecture is optimized for high speed and ease of use. The analog inputs drive an integrated, high bandwidth track-and-hold circuit that samples the signal prior to quantization by the 16-bit pipeline ADC core. The device includes an on-board reference and input logic that accepts TTL, CMOS, or LVPECL levels. The digital output logic levels are user selectable as standard 3 V CMOS or LVDS (ANSI-644 compatible) via the OUTPUT MODE pin.

ANALOG INPUT AND REFERENCE OVERVIEW

A stable and accurate 0.5 V band gap voltage reference is built into the AD9446. The input range can be adjusted by varying the reference voltage applied to the AD9446, using either the internal reference or an externally applied reference voltage. The input span of the ADC tracks reference voltage changes linearly.

Internal Reference Connection

A comparator within the AD9446 detects the potential at the SENSE pin and configures the reference into three possible states, which are summarized in Table 9. If SENSE is grounded, the reference amplifier switch is connected to the internal resistor divider (see Figure 55), setting VREF to ~1.6 V. If a resistor divider is connected as shown in Figure 56, the switch again sets to the SENSE pin. This puts the reference amplifier in a noninverting mode with the VREF output defined as

$$VREF = 0.5 V \times \left(1 + \frac{R2}{R1} \right)$$

In all reference configurations, REFT and REFB drive the analog-to-digital conversion core and establish its input span. The input range of the ADC always equals twice the voltage at the reference pin for either an internal or an external reference.

Internal Reference Trim

The internal reference voltage is trimmed during the production test; therefore, there is little advantage to the user supplying an external voltage reference to the AD9446. The gain trim is performed with the AD9446 input range set to 3.2 V p-p nominal (SENSE connected to AGND). Because of this trim and the maximum ac performance provided by the 3.2 V p-p analog input range, there is little benefit to using analog input ranges

<2 V p-p. However, reducing the range can improve SFDR performance in some applications. Likewise, increasing the range up to 3.8 V p-p can improve SNR. Users are cautioned that the differential nonlinearity of the ADC varies with the reference voltage. Configurations that use <2.0 V p-p may exhibit missing codes and therefore degraded noise and distortion performance.

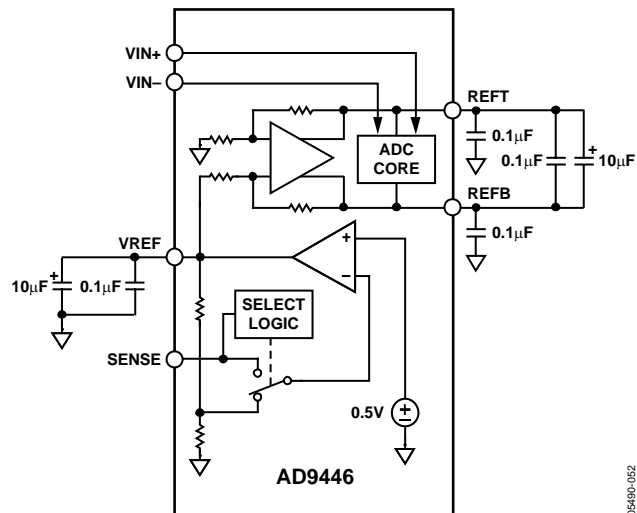

Figure 55. Internal Reference Configuration

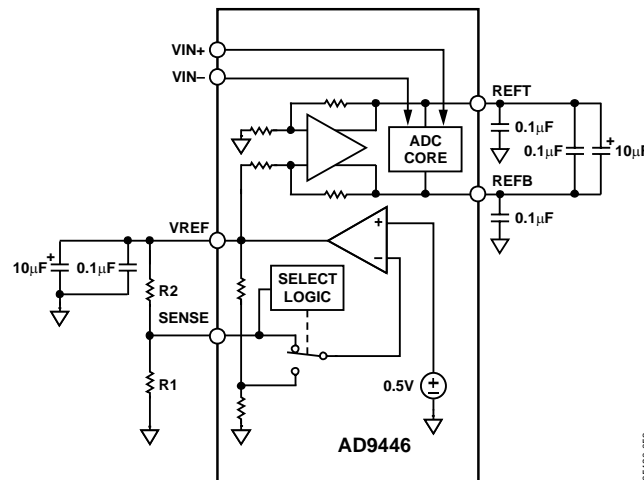

Figure 56. Programmable Reference Configuration

Table 9. Reference Configuration Summary

Selected Mode	SENSE Voltage	Resulting VREF (V)	Resulting Differential Span (V p-p)
External Reference	AVDD	N/A	2 × external reference
Programmable Reference	0.2 V to VREF	$0.5 \times \left(1 + \frac{R2}{R1}\right)$ (See Figure 56)	2 × VREF
Programmable Reference (Set for 2 V p-p)	0.2 V to VREF	$0.5 \times \left(1 + \frac{R2}{R1}\right)$, R1 = R2 = 1 kΩ	2.0
Programmable Reference (Set for 2 V p-p)	0.2 V to VREF	$0.5 \times \left(1 + \frac{R2}{R1}\right)$, R1 = 1 kΩ, R2 = 2.8 kΩ	3.8
Internal Fixed Reference	AGND to 0.2 V	1.6	3.2

External Reference Operation

When the SENSE pin is tied to AVDD, the internal reference is disabled, allowing the use of an external reference. An internal reference buffer loads the external reference with an equivalent 7 kΩ load. The internal buffer still generates the positive and negative full-scale references, REFT and REFB, for the ADC core. The input span is always twice the value of the reference voltage; therefore, the external reference must be limited to a maximum of 2.0 V. See Figure 46 for gain variation vs. temperature.

Analog Inputs

As with most new high speed, high dynamic range ADCs, the analog input to the AD9446 is differential. Differential inputs improve on-chip performance because signals are processed through attenuation and gain stages. Most of the improvement is a result of differential analog stages having high rejection of even-order harmonics. There are also benefits at the PCB level. First, differential inputs have high common-mode rejection of stray signals, such as ground and power noise. Second, they provide good rejection of common-mode signals, such as local oscillator feedthrough. The specified noise and distortion of the AD9446 cannot be realized with a single-ended analog input, so such configurations are discouraged. Contact sales for recommendations of other 16-bit ADCs that support single-ended analog input configurations.

With the 1.6 V reference, which is the nominal value (see the Internal Reference Trim section), the differential input range of the AD9446 analog input is nominally 3.2 V p-p or 1.6 V p-p on each input (VIN+ or VIN-).

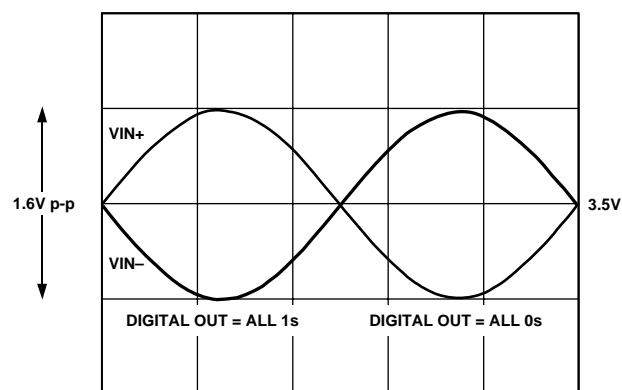

Figure 57. Differential Analog Input Range for VREF = 1.6 V

The AD9446 analog input voltage range is offset from ground by 3.5 V. Each analog input connects through a 1 kΩ resistor to the 3.5 V bias voltage and to the input of a differential buffer. The internal bias network on the input properly biases the buffer for maximum linearity and range (see the Equivalent Circuits section). Therefore, the analog source driving the AD9446 should be ac-coupled to the input pins. The recommended method for driving the analog input of the AD9446 is to use an RF transformer to convert single-ended signals to differential (see Figure 58). Series resistors between the output of the transformer and the AD9446 analog inputs help isolate the analog input source from switching transients caused by the internal sample-and-hold circuit. The series resistors, along with the 1 kΩ resistors connected to the internal 3.5 V bias, must be considered in impedance matching the transformer input. For example, if R_T is set to 51 Ω, R_S is set to 33 Ω and there is a 1:1 impedance ratio transformer, the input will match a 50 Ω source with a full-scale drive of 16.0 dBm. The 50 Ω impedance matching can also be incorporated on the secondary side of the transformer, as shown in the evaluation board schematic (see Figure 61).

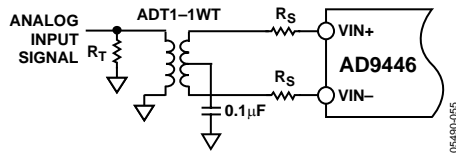

Figure 58. Transformer-Coupled Analog Input Circuit

CLOCK INPUT CONSIDERATIONS

Any high speed ADC is extremely sensitive to the quality of the sampling clock provided by the user. A track-and-hold circuit is essentially a mixer, and any noise, distortion, or timing jitter on the clock is combined with the desired signal at the analog-to-digital output. For that reason, considerable care was taken in the design of the clock inputs of the AD9446, and the user is advised to give careful thought to the clock source.

Typical high speed ADCs use both clock edges to generate a variety of internal timing signals and, as a result, may be sensitive to the clock duty cycle. Commonly a 5% tolerance is required on the clock duty cycle to maintain dynamic performance characteristics. The AD9446 contains a clock duty cycle stabilizer (DCS) that retimes the nonsampling edge, providing an internal clock signal with a nominal ~50% duty cycle. Noise and distortion performance are nearly flat for a 30% to 70% duty cycle with the DCS enabled. The DCS circuit locks to the rising edge of CLK+ and optimizes timing internally. This allows for a wide range of input duty cycles at the input without degrading performance. Jitter in the rising edge of the input is still of paramount concern and is not reduced by the internal stabilization circuit. The duty cycle control loop does not function for clock rates of less than 30 MHz nominally. The loop is associated with a time constant that should be considered in applications where the clock rate can change dynamically, requiring a wait time of 1.5 µs to 5 µs after a dynamic clock frequency increase or decrease before the DCS loop is relocked to the input signal. During the time that the loop is not locked, the DCS loop is bypassed, and the internal device timing is dependent on the duty cycle of the input clock signal. In such an application, it may be appropriate to disable the duty cycle stabilizer. In all other applications, enabling the DCS circuit is recommended to maximize ac performance.

The DCS circuit is controlled by the DCS MODE pin; a CMOS logic low (AGND) on DCS MODE enables the duty cycle stabilizer, and logic high (AVDD1 = 3.3 V) disables the controller.

The AD9446 input sample clock signal must be a high quality, extremely low phase noise source to prevent degradation of performance. Maintaining 16-bit accuracy places a premium on the encode clock phase noise. SNR performance can easily degrade by 3 dB to 4 dB with 70 MHz analog input signals when using a high jitter clock source. (See the [AN-501 Application Note](#), “Aperture Uncertainty and ADC System Performance.”) For optimum performance, the AD9446 must be clocked differentially. The sample clock inputs are internally biased to ~1.5 V, and the input signal is usually ac-coupled into the CLK+ and CLK- pins

via a transformer or capacitors. Figure 59 shows one preferred method for clocking the AD9446. The clock source (low jitter) is converted from single-ended to differential using an RF transformer. The back-to-back Schottky diodes across the secondary of the transformer limit clock excursions into the AD9446 to approximately 0.8 V p-p differential. This helps prevent the large voltage swings of the clock from feeding through to other portions of the AD9446 and limits the noise presented to the sample clock inputs.

If a low jitter clock is available, it may help to band-pass filter the clock reference before driving the ADC clock inputs. Another option is to ac couple a differential ECL/PECL signal to the encode input pins, as shown in Figure 60.

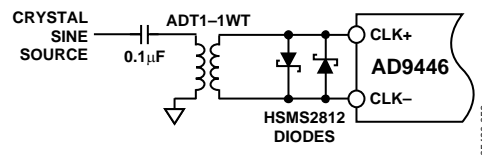

Figure 59. Crystal Clock Oscillator, Differential Encode

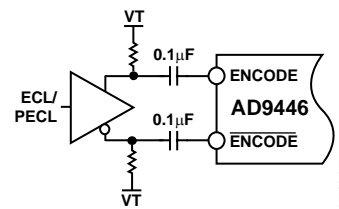

Figure 60. Differential ECL for Encode

Jitter Considerations

High speed, high resolution ADCs are sensitive to the quality of the clock input. The degradation in SNR at a given input frequency (f_{INPUT}) and rms amplitude due only to aperture jitter (t_j) can be calculated using the following equation:

$$SNR = 20 \log[2\pi f_{INPUT} \times t_j]$$

In the equation, the rms aperture jitter represents the root-mean-square of all jitter sources, which includes the clock input, analog input signal, and ADC aperture jitter specification. IF under-sampling applications are particularly sensitive to jitter

The clock input should be treated as an analog signal in cases where aperture jitter may affect the dynamic range of the AD9446. Power supplies for clock drivers should be separated from the ADC output driver supplies to avoid modulating the clock signal with digital noise. Low jitter crystal-controlled oscillators make the best clock sources. If the clock is generated from another type of source (by gating, dividing, or another method), it should be synchronized by the original clock during the last step.

POWER CONSIDERATIONS

Care should be taken when selecting a power source. The use of linear dc supplies is highly recommended. Switching supplies tend to have radiated components that may be received by the AD9446. Each of the power supply pins should be decoupled as closely to the package as possible using 0.1 μ F chip capacitors.

The AD9446 has separate digital and analog power supply pins. The analog supplies are denoted AVDD1 (3.3 V) and AVDD2 (5 V), and the digital supply pins are denoted DRVDD. Although the AVDD1 and DRVDD supplies can be tied together, best performance is achieved when the supplies are separate. This is because the fast digital output swings can couple switching current back into the analog supplies. Note that both AVDD1 and AVDD2 must be held within 5% of the specified voltage.

The DRVDD supply of the AD9446 is a dedicated supply for the digital outputs in either LVDS or CMOS output mode. When in LVDS mode, the DRVDD should be set to 3.3 V. In CMOS mode, the DRVDD supply can be connected from 2.5 V to 3.6 V for compatibility with the receiving logic.

DIGITAL OUTPUTS

LVDS Mode

The off-chip drivers on the chip can be configured to provide LVDS-compatible output levels via Pin 3 (OUTPUT MODE). LVDS outputs are available when OUTPUT MODE is CMOS logic high (or AVDD1 for convenience) and a 3.74 k Ω R_{SET} resistor is placed at Pin 5 (LVDS_BIAS) to ground. Dynamic performance, including both SFDR and SNR, is maximized when the AD9446 is used in LVDS mode; designers are encouraged to take advantage of this mode. The AD9446 outputs include complimentary LVDS outputs for each data bit ($Dx+/Dx-$), the overrange output ($OR+/OR-$), and the output

data clock output ($DCO+/DCO-$). The R_{SET} resistor current is multiplied on-chip, setting the output current at each output equal to a nominal 3.5 mA ($11 \times I_{R_{SET}}$). A 100 Ω differential termination resistor placed at the LVDS receiver inputs results in a nominal 350 mV swing at the receiver. LVDS mode facilitates interfacing with LVDS receivers in custom ASICs and FPGAs that have LVDS capability for superior switching performance in noisy environments. Single point-to-point net topologies are recommended, with a 100 Ω termination resistor located as close to the receiver as possible. It is recommended to keep the trace length less than 2 inches and to keep differential output trace lengths as equal as possible.

CMOS Mode

In applications that can tolerate a slight degradation in dynamic performance, the AD9446 output drivers can be configured to interface with 2.5 V or 3.3 V logic families by matching DRVDD to the digital supply of the interfaced logic. CMOS outputs are available when OUTPUT MODE is CMOS logic low (or AGND for convenience). In this mode, the output data bits, Dx , are single-ended CMOS, as is the overrange output, $OR+$. The output clock is provided as a differential CMOS signal, $DCO+/DCO-$. Lower supply voltages are recommended to avoid coupling switching transients back to the sensitive analog sections of the ADC. The capacitive load to the CMOS outputs should be minimized, and each output should be connected to a single gate through a series resistor (220 Ω) to minimize switching transients caused by the capacitive loading.

TIMING

The AD9446 provides latched data outputs with a pipeline delay of 13 clock cycles. Data outputs are available one propagation delay (t_{PD}) after the rising edge of $CLK+$. Refer to Figure 2 and Figure 3 for detailed timing diagrams.

AD9446

OPERATIONAL MODE SELECTION

Data Format Select

The data format select (DFS) pin of the AD9446 determines the coding format of the output data. This pin is 3.3 V CMOS compatible, with logic high (or AVDD1, 3.3 V) selecting twos complement and DFS logic low (AGND) selecting offset binary format. Table 10 summarizes the output coding.

Output Mode Select

The OUPUT MODE pin controls the logic compatibility, as well as the pinout of the digital outputs. This pin is a CMOS-

compatible input. With OUTPUT MODE = 0 (AGND), the AD9446 outputs are CMOS compatible, and the pin assignment for the device is as defined in Table 8. With OUTPUT MODE = 1 (AVDD1, 3.3 V), the AD9446 outputs are LVDS compatible, and the pin assignment for the device is as defined in Table 7.

Duty Cycle Stabilizer

The DCS circuit is controlled by the DCS MODE pin; a CMOS logic low (AGND) on DCS MODE enables the DCS, and logic high (AVDD1, 3.3 V) disables the controller.

Table 10. Digital Output Coding

Code	VIN+ – VIN– Input Span = 3.2 V p-p (V)	VIN+ – VIN– Input Span = 2 V p-p (V)	Digital Output Offset Binary (D15.....D0)	Digital Output Twos Complement (D15.....D0)
65,536	+1.600	+1.000	1111 1111 1111 1111	0111 1111 1111 1111
32,768	0	0	1000 0000 0000 0000	0000 0000 0000 0000
32,767	–0.0000488	–0.000122	0111 1111 1111 1111	1111 1111 1111 1111
0	–1.60	–1.00	0000 0000 0000 0000	1000 0000 0000 0000

EVALUATION BOARD

Evaluation boards are offered to configure the AD9446 in either CMOS or LVDS mode only. This design represents a recommended configuration for using the device over a wide range of sampling rates and analog input frequencies. These evaluation boards provide all the support circuitry required to operate the ADC in its various modes and configurations. Complete schematics are shown in Figure 61 through Figure 64. Gerber files are available from engineering applications demonstrating the proper routing and grounding techniques that should be applied at the system level.

It is critical that signal sources with very low phase noise (<60 fsec rms jitter) be used to realize the ultimate performance of the converter. Proper filtering of the input signal to remove harmonics and lower the integrated noise at the input is also necessary to achieve the specified noise performance.

The evaluation boards are shipped with a 115 V ac to 6 V dc power supply. The evaluation boards include low dropout regulators to generate the various dc supplies required by the AD9446 and its support circuitry. Separate power supplies are provided to isolate the DUT from the support circuitry. Each input configuration can be selected by proper connection of various jumpers (see Figure 61).

The LVDS mode evaluation boards include an LVDS-to-CMOS translator, making them compatible with the high speed ADC FIFO evaluation kit (HSC-ADC-EVALA-SC). The kit includes a high speed data capture board that provides a hardware solution for capturing up to 32 kB samples of high speed ADC output data in a FIFO memory chip (user upgradeable to 256 kB samples). Software is provided to enable the user to download the captured data to a PC via the USB port. This software also includes a behavioral model of the AD9446 and many other high speed ADCs.

Behavioral modeling of the AD9446 is also available at www.analog.com/ADIsimADC. The ADIsimADC™ software supports virtual ADC evaluation using ADI proprietary behavioral modeling technology. This allows rapid comparison between the AD9446 and other high speed ADCs with or without hardware evaluation boards.

The user can choose to remove the translator and terminations to access the LVDS outputs directly.

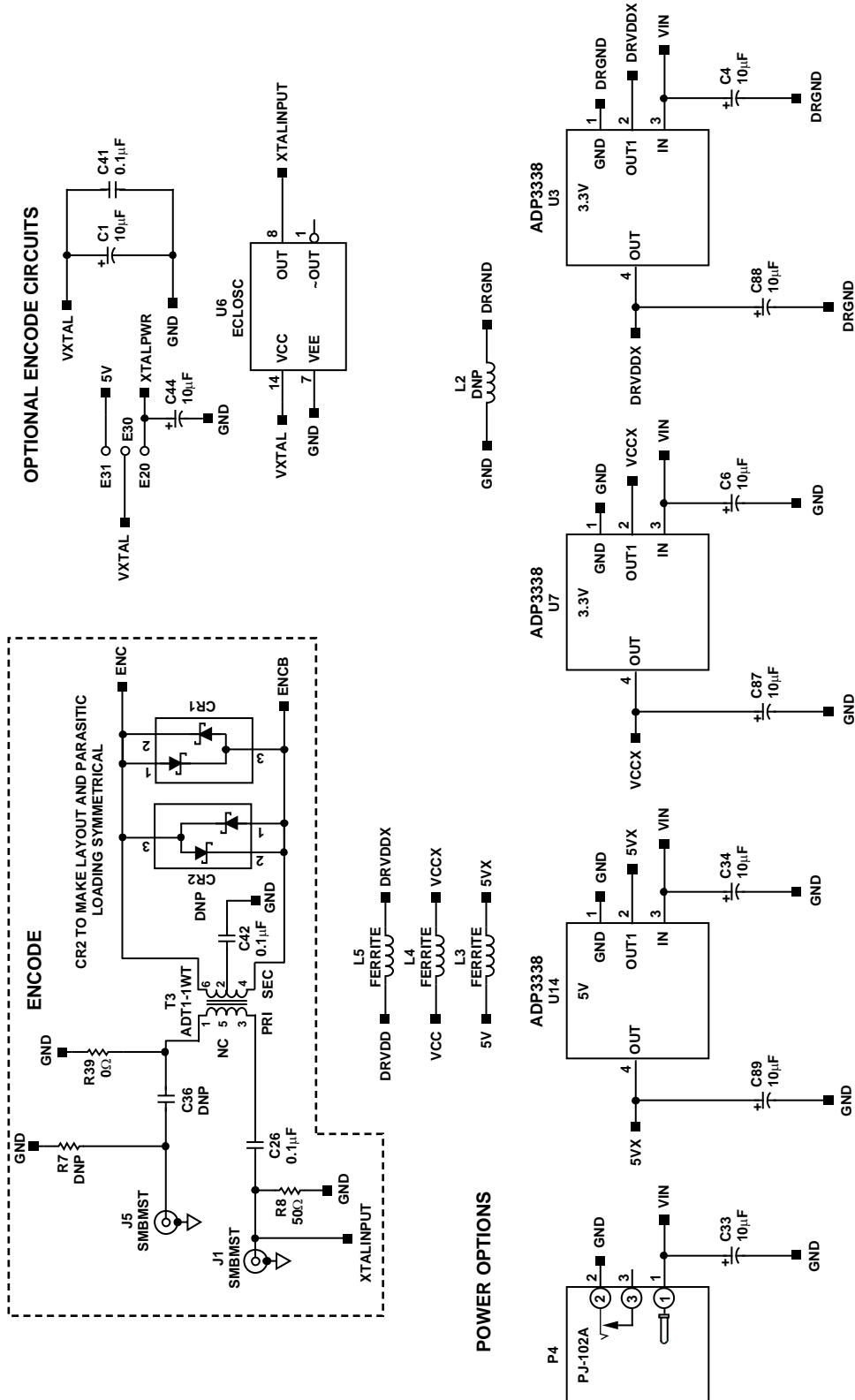

Figure 62. AD9446 Evaluation Board Schematic (Continued)

05490-060

BYPASS CAPACITORS

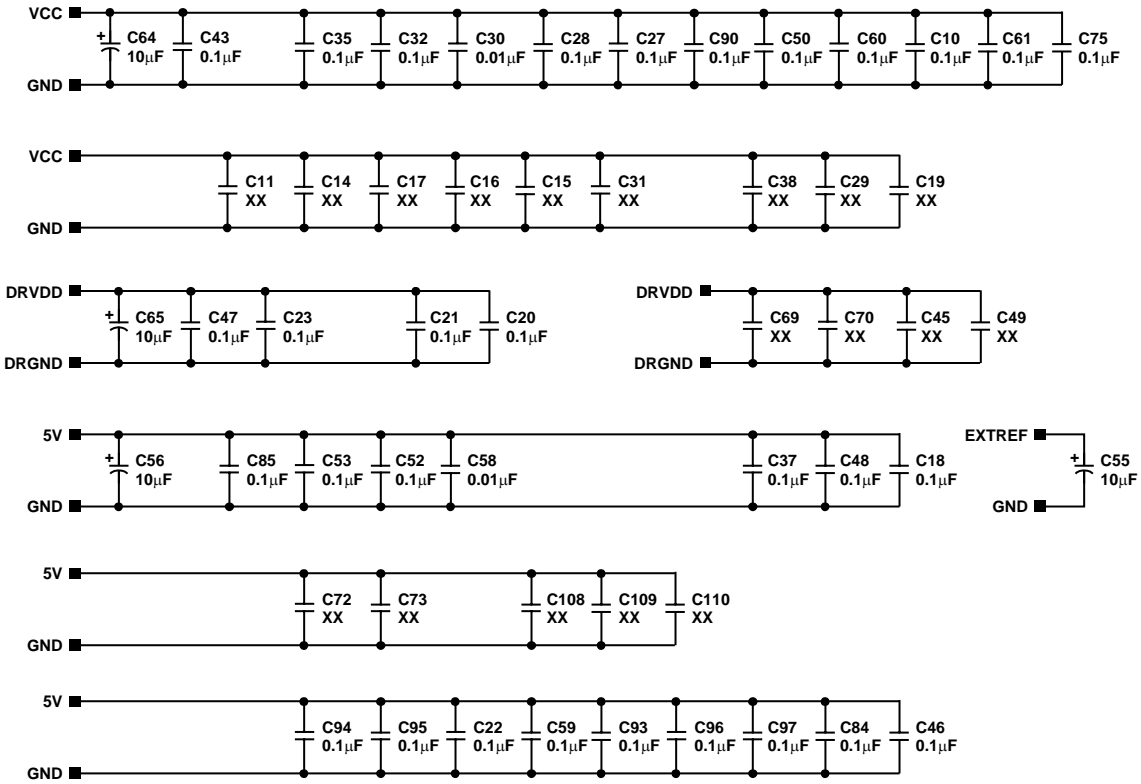

Figure 63. AD9446 Evaluation Board Schematic (Continued)

05490-061

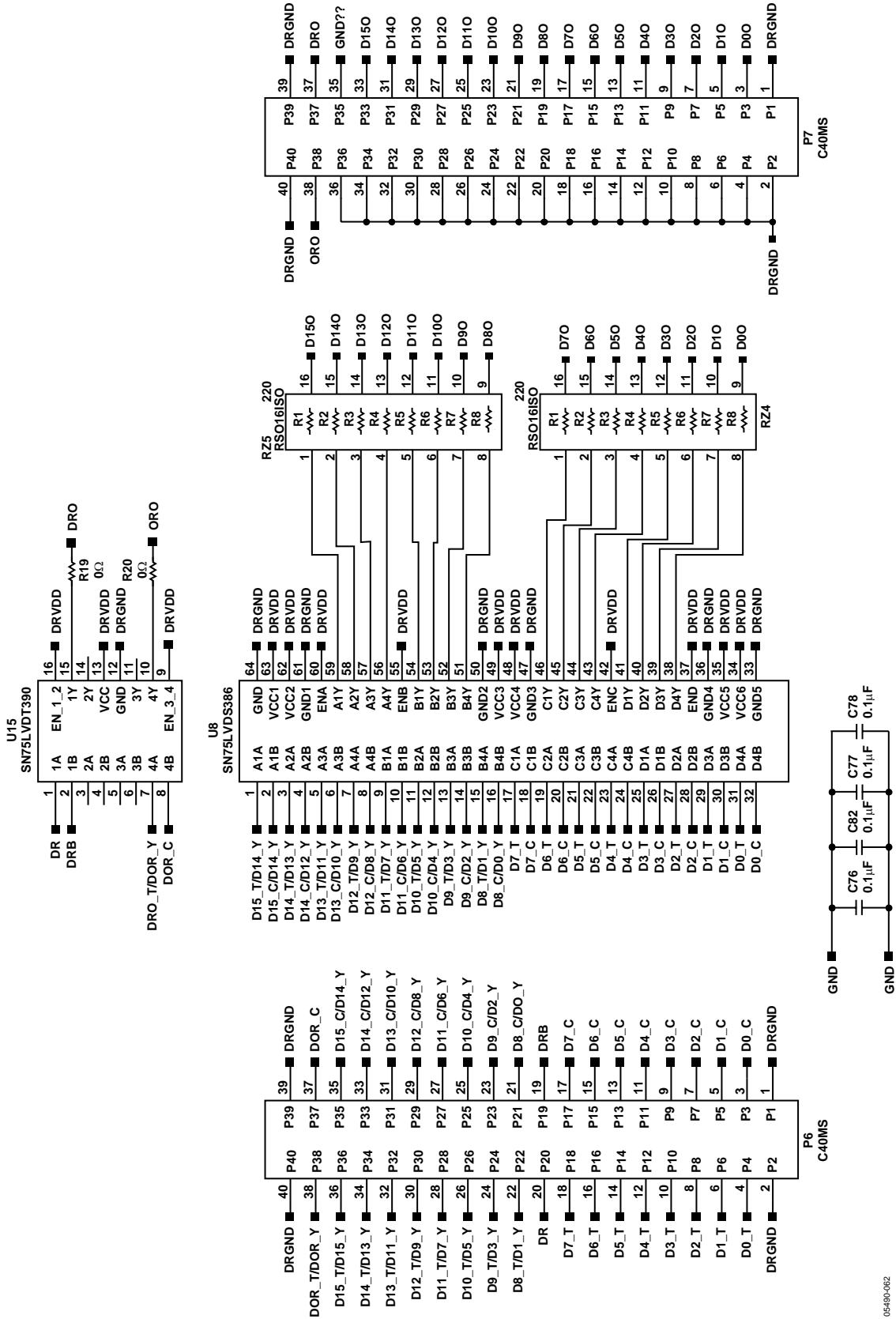

Figure 64. AD9446 Evaluation Board Schematic (Continued)

05480-062

AD9446

Table 11. AD9446 Customer Evaluation Board Bill of Material

Item	Qty.	Reference Designator	Description	Package	Value	Manufacturer	Mfg. Part No.
1	7	C4, C6, C33, C34, C87, C88, C89	Capacitor	TAJD	10 μ F	Digi-Key Corporation	478-1699-2
2	44	C2, C3, C5, C7, C8, C9, C10, C11, C12, C15, C20, C21, C22, C23, C26, C27, C28, C32, C35, C38, C40, C42, C43, C46, C47, C48, C50, C52, C53, C59, C60, C76, C77, C78, C82, C84, C85, C86, C90, C91, C94, C95, C96, C97	Capacitor	402	0.1 μ F	Digi-Key Corporation	PCC2146CT-ND
3	2	C30, C58	Capacitor	201	0.01 μ F	Digi-Key Corporation	445-1796-1-ND
4	4	C39, C56, C64, C65	Capacitor	TAJD	10 μ F	Digi-Key Corporation	478-1699-2
5	1	C51	Capacitor	805	10 μ F	Digi-Key Corporation	490-1717-1-ND
6	1	CR1	Diode	SOT23M5		Digi-Key Corporation	MA3X71600LCT-ND
7	1	CR2	Diode	SOT23M5		Digi-Key Corporation	MA3X71600LCT-ND
8	20	E1, E2, E3, E4, E5, E6, E9, E10, E14, E18, E19, E20, E24, E25, E26, E27, E30, E31, E36, E41	Header	EHOLE		Mouser Electronics	517-6111TG
9	2	J1, J4	SMA	SMA		Digi-Key Corporation	ARFX1231-ND
10	1	L1	Inductor	0603A	10 nH	Coilcraft, Inc.	0603CS-10NXGBU
11	3	L3, L4, L5	EMIFIL® BLM31PG500SN1L	1206MIL		Mouser Electronics	81-BLM31P500S
12	1	P4	PJ-002A	PJ-002A		Digi-Key Corporation	CP-002A-ND
13	1	P7	Header	C40MS		Samtec, Inc.	TSW-120-08-L-D-RA
14	1	R3	Resistor	402	3.74 k Ω	Digi-Key Corporation	P3.74KLCT-ND
15	1	R8	Resistor	402	50 Ω	Digi-Key Corporation	P49.9LCT-ND
16	4	R10, R19, R39, L2	Resistor	402	0 Ω	Digi-Key Corporation	P0.0JCT-ND
17	1	R11	BRES402	402	1 k Ω	Digi-Key Corporation	P1.0KLCT-ND
18	2	R28, R35	Resistor	402	33 Ω	Digi-Key Corporation	P33JCT-ND
19	2	RZ4, RZ5	Resistor array	16PIN	22 Ω	Digi-Key Corporation	742C163220JCT-ND
20	2	T3, T5	Transformer	ADT1-1WT		Mini-Circuits	ADT1-1WT
21	1	U1	AD9445BSVZ-125	SV-100-3		Analog Devices, Inc.	AD9445BSVZ-100
22	1	U14	ADP3338-5	SOT-223HS		Analog Devices, Inc.	ADP3338-5
23	2	U3, U7	ADP3338-3.3	SOT-223HS		Analog Devices, Inc.	ADP3338-33
24	1	U8	SN75LVDT386	TSSOP64		Arrow Electronics, Inc.	SN75LVDT386
25	1	U15	SN75LVDT390	SOIC16PW		Arrow Electronics, Inc.	SN75LVDT390
26	2	R4, R6	Resistor	402	36 Ω	Digi-Key Corporation	P36JCT-ND
27	2	C1, C44, C55 ¹	Capacitor	TAJD	10 μ F	Digi-Key Corporation	478-1699-2
28	23	C13, C14, C16, C17, C18, C19, C29, C31, C36, C37, C41, C45, C49, C61, C69, C70, C72, C73, C75, C93, C108, C109, C110 ¹	CAP402	402	XX		
29	1	C98 ¹	Capacitor	805	10 μ F	Digi-Key Corporation	490-1717-1-ND

Item	Qty.	Reference Designator	Description	Package	Value	Manufacturer	Mfg. Part No.
30		E15 ¹	Header	EHOLE		Mouser Electronics	517-6111TG
31		J5 ¹	SMA	SMA		Digi-Key Corporation	ARFX1231-ND
32		P6 ¹	Header	C40MS		Samtec, Inc.	TSW-120-08-L-D-RA
33	2	R1, R2 ¹	BRES402	402	XX		
34	3	R5, R7, R9 ¹	BRES402	402	XX		
35	1	U2 ¹	ECLOSC	DIP4(14)			
36	4	H1, H2, H3, H4 ¹	MTHOLE6	MTHOLE6			
37	2	T1, T2 ¹	Balun transformer	SM-22		M/A-COM	ETC1-1-13
38	2	P21, P22 ¹	Term strip	PTMICRO4		Newark Electronics	

¹ Parts not populated.

OUTLINE DIMENSIONS

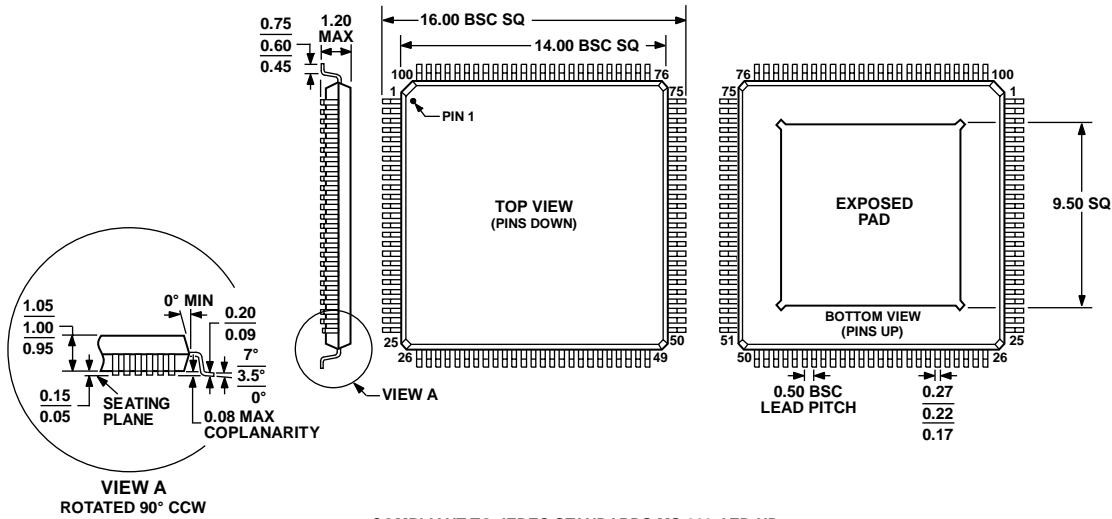

COMPLIANT TO JEDEC STANDARDS MS-026-AED-HD

NOTES

- CENTER FIGURES ARE TYPICAL UNLESS OTHERWISE NOTED.
- THE PACKAGE HAS A CONDUCTIVE HEAT SLUG TO HELP DISSIPATE HEAT AND ENSURE RELIABLE OPERATION OF THE DEVICE OVER THE FULL INDUSTRIAL TEMPERATURE RANGE. THE SLUG IS EXPOSED ON THE BOTTOM OF THE PACKAGE AND ELECTRICALLY CONNECTED TO CHIP GROUND. IT IS RECOMMENDED THAT NO PCB SIGNAL TRACES OR VIAS BE LOCATED UNDER THE PACKAGE THAT COULD COME IN CONTACT WITH THE CONDUCTIVE SLUG. ATTACHING THE SLUG TO A GROUND PLANE WILL REDUCE THE JUNCTION TEMPERATURE OF THE DEVICE WHICH MAY BE BENEFICIAL IN HIGH TEMPERATURE ENVIRONMENTS.

Figure 65. 100-Lead Thin Quad Flat Package, Exposed Pad [TQFP_EP] (SV-100-3)

Dimensions shown in millimeters

ORDERING GUIDE

Model	Temperature Range	Package Description	Package Option
AD9446BSVZ-80 ¹	-40°C to +85°C	100-Lead TQFP_EP	SV-100-3
AD9446BSVZ-100 ¹	-40°C to +85°C	100-Lead TQFP_EP	SV-100-3
AD9446-100LVDS/PCB		AD9446-100 LVDS Mode Evaluation Board	
AD9446-80LVDS/PCB		AD9446-80 LVDS Mode Evaluation Board	

¹ Z = Pb-free part.