



EC7AW SERIES 10 WATT 4:1 INPUT ISOLATED DC-DC CONVERTER

Features

- Efficiency up to 89%
- Fixed Switching Frequency
- Regulated Outputs
- Remote On/Off
- Low No Load Power Consumption
- Fully Protected (OCP/OVP/UVLO)
- 3000Vdc I/O Isolation
- No Tantalum Capacitor Inside
- DIP-24 Metal Package
- Meets Industrial Standard 1.25"x0.80"x0.40"
- Safety Meets IEC/EN/UL 62368-1
- EMI Meets EN55032 Class A
Without External Component



MODEL NUMBER	INPUT VOLTAGE	OUTPUT VOLTAGE	OUTPUT CURRENT		INPUT CURRENT		% EFF.		CAPACITOR LOAD MAX.
			MIN.	MAX.	NO LOAD	FULL LOAD	(1)	(2)	
EC7AW-24S33	9-36 VDC	3.3 VDC	0 mA	2000 mA	6 mA	340 mA	81	81.5	2000uF
EC7AW-24S05	9-36 VDC	5 VDC	0 mA	2000 mA	6 mA	487 mA	85.5	86	2000uF
EC7AW-24S12	9-36 VDC	12 VDC	0 mA	833 mA	6 mA	471 mA	88.5	89	833uF
EC7AW-24S15	9-36 VDC	15 VDC	0 mA	666 mA	7 mA	468 mA	89	89.5	666uF
EC7AW-24D12	9-36 VDC	±12 VDC	0 mA	±417 mA	8 mA	474 mA	88	88.5	417uF
EC7AW-24D15	9-36 VDC	±15 VDC	0 mA	±333 mA	10 mA	473 mA	88	89	333uF
EC7AW-48S33	18-74 VDC	3.3 VDC	0 mA	2000 mA	6 mA	171 mA	80.5	81.5	2000uF
EC7AW-48S05	18-74 VDC	5 VDC	0 mA	2000 mA	6 mA	244 mA	85.5	86	2000uF
EC7AW-48S12	18-74 VDC	12 VDC	0 mA	833 mA	6 mA	235 mA	88.5	90	833uF
EC7AW-48S15	18-74 VDC	15 VDC	0 mA	666 mA	6 mA	234 mA	89	89.5	666uF
EC7AW-48D12	18-74 VDC	±12 VDC	0 mA	±417 mA	6 mA	237 mA	88	89.5	417uF
EC7AW-48D15	18-74 VDC	±15 VDC	0 mA	±333 mA	7 mA	237 mA	88	89.5	333uF

NOTE:

1. Nominal Input Voltage 24 or 48 VDC
2. Measured at 12VDC for 24Vin, 24VDC for 48Vin

PART NUMBER

Series	Nominal Input Voltage	Number of Outputs	Nominal Output Voltage	Remote On/Off Logic
EC7AW-	II	O	XX	L
EC7AW	24: 24VDC	S: Single D: Dual	33: 3.3VDC	None: Positive N: Negative
	48: 48VDC		05: 5.0VDC	
			12: 12VDC 15: 15VDC	

Part Number Example:

EC7AW-24S12N: 1.25"x0.8", 10W, 4:1 9-36Vdc Input, Single 12Vdc Output, Negative Logic



TECHNICAL SPECIFICATIONS

(All specifications are typical at nominal input, full load at 25°C unless otherwise noted.)

ABSOLUTE MAXIMUM RATINGS

PARAMETER	NOTES and CONDITIONS	Device	Min.	Typ.	Max.	Units
Input Voltage	Continuous	24Vin	-0.3		36	V _{dc}
		48Vin	-0.3		74	
Input Surge Voltage	100ms max.	24Vin			50	V _{dc}
		48Vin			100	
Operating Ambient Temperature	With de-rating, above 71°C	Vo=3.3V Vo=5V	-40		85	°C
	With de-rating, above 75°C	Vo=12V Vo=15V Vo=±12V Vo=±15V				
Operating Case Temperature	At the Center Part of Case Plate	All	-40		105	°C
Storage Temperature		All	-55		125	°C

INPUT CHARACTERISTICS

PARAMETER	NOTES and CONDITIONS	Device	Min.	Typ.	Max.	Units
Operating Input Voltage		24Vin	9	24	36	V _{dc}
		48Vin	18	48	74	
Input Under Voltage Lockout						
Turn-On Voltage Threshold	100% Load	24Vin	8	8.5	8.8	V _{dc}
		48Vin	16.5	17	17.5	
Turn-Off Voltage Threshold	100% Load	24Vin	7.5	8	8.3	V _{dc}
		48Vin	15.5	16	16.5	
Lockout Hysteresis Voltage	100% Load	24Vin		0.5		V _{dc}
		48Vin		1		
Maximum Input Current	V _{in} =9V, Full Load	24Vin		1.4		A
	V _{in} =18V, Full Load	48Vin		0.7		
No-Load Input Current	V _{in} =Nominal, I _o =0A	See Model Number Table				mA
Input Filter	Pi filter	All				
Inrush Current (I ² t)	As per ETS300 132-2	All			0.1	A ² s
Input Reflected Ripple Current	P-P thru 12uH inductor, 5Hz to 20MHz	All		30		mA

OUTPUT CHARACTERISTICS

PARAMETER	NOTES and CONDITIONS	Device	Min.	Typ.	Max.	Units
Voltage Set Point Accuracy	V _{in} =Nominal, Full Load, T _c =25°C	All	-1.0		+1.0	%
Output Voltage Balance	V _{in} =Nominal, Full Load, T _c =25°C	Dual	-1.0		+1.0	%
Output Voltage Regulation						
Load Regulation	Full Load to No Load	All			±1.0	%
Line Regulation	V _{in} =High Line to Low Line, Full Load	All			±0.2	%
Temperature Coefficient	T _c =-40°C to 85°C	All			±0.02	%/°C
Output Voltage Ripple and Noise (5Hz to 20MHz Bandwidth)						
Peak-to-Peak	Full load, 1.0uF ceramic capacitors	3.3Vo			100	mV
		5Vo			100	
		12Vo			120	
		15Vo			150	
Output Current Range	V _{in} =Nominal,	See Model Number Table				A
Over Current Protection	Hiccup Mode. Auto Recovery	All	110	140	170	%
Short Circuit Protection		All	Continuous, Auto Recovery			
External Load Capacitance	Full Load (Resistive)	See Model Number Table				uF



EC7AW Series

PARAMETER	NOTES and CONDITIONS	Device	Min.	Typ.	Max.	Units
Over Voltage Protection	Zener Clamp	3.3Vo		3.9		V _{dc}
		5Vo		6.2		
		12Vo		15		
		15Vo		18		
		±12Vo		±15		
		±15Vo		±18		

EFFICIENCY

PARAMETER	NOTES and CONDITIONS	Device	Min.	Typ.	Max.	Units
100% Load	V _{in} =Nominal, Full Load, T _c =25°C		See Model Number Table			%

DYNAMIC CHARACTERISTICS

PARAMETER	NOTES and CONDITIONS	Device	Min.	Typ.	Max.	Units
Output Voltage Current Transient						
Error Band	75% to 100% of I _{o_max} step load change d _i /d _t =0.1A/us (within 1% V _{out} nominal)	All			±5	%
Recovery Time		All			250	us
Turn-On Delay and Rise Time						
Full load (Constant resistive load)						
Turn-On Delay Time, From On/Off Control	V _{on/off} to 10%V _{o_set} , Remote On	All		5		ms
Turn-On Delay Time, From Input	V _{in_min} to 10%V _{o_set} , Power Up	All		5		ms
Output Voltage Rise Time	10%V _{o_set} to 90%V _{o_set}	5Vo		10		ms
		Others		5		

ISOLATION CHARACTERISTICS

PARAMETER	NOTES and CONDITIONS	Device	Min.	Typ.	Max.	Units
Isolation Voltage (100% factory Hi-Pot tested @2sec.)	1 minute; Input to Output	All			2000	V _{ac}
					3000	V _{dc}
Isolation Resistance	Input to Output	All	1000			MΩ
Isolation Capacitance	Input to Output (10KHz, 0.25V)	All		1000		pF

FEATURE CHARACTERISTICS

PARAMETER	NOTES and CONDITIONS	Device	Min.	Typ.	Max.	Units
Switching Frequency	Output Ripple Frequency	All	477	530	583	KHz
On/Off Control, Positive Remote On/Off logic, Refer to -Vin pin.						
Logic Low (Module Off)	V _{on/off} at I _{on/off} =1.0mA	All	0		1.2	V
Logic High (Module On)	V _{on/off} at I _{on/off} =0.0uA, Pin open=On	All	3.5 or Open Circuit		74	V
On/Off Control, Negative Remote On/Off logic, Refer to -Vin pin						
Logic High (Module Off)	V _{on/off} at I _{on/off} =0.0uA, Pin open=Off	All	3.5 or Open Circuit		74	V
Logic Low (Module On)	V _{on/off} at I _{on/off} =1.0mA	All	0		1.2	V
On/Off Current (for both remote on/off logic)	I _{on/off} at V _{on/off} =0V	All		0.4	1	mA
Leakage Current (for both remote on/off logic)	Logic High, V _{on/off} =15V	All			30	uA
Off Converter Input Current	Shutdown input idle current	All		3	5	mA
PARAMETER	NOTES and CONDITIONS	Device	Min.	Typ.	Max.	Units



EC7AW Series

GENERAL SPECIFICATIONS

PARAMETER	NOTES and CONDITIONS	Device	Min.	Typ.	Max.	Units
MTBF	$I_o=100\%$ of $I_{o,max}$; MIL-HDBK - 217F_Notice 1, GB, 25°C	24S33		1727		K hours
		24S05		1520		
		24S12		1634		
		24S15		1711		
		24D12		1466		
		24D15		1579		
		48S33		1725		
		48S05		1605		
		48S12		1583		
		48S15		1715		
		48D12		1453		
		48D15		1585		
		Weight		All		
Case Material	Black Coated Copper					
Base plate Material	Non-Conductive Base					
Potting Material	UL 94V-0					
Pin Material	Base: Copper with Steel Plating: Barrel Tin					
Shock/Vibration	MIL-STD-810F Compliant					
Humidity	95% RH max. Non Condensing					
Altitude	2000m Operating Altitude					
Thermal Shock	MIL-STD-810F					
Application Note Link	EC7AW Series App Notes					
Packaging Information Link	Packaging Information					

CHARACTERISTIC CURVE

Power Derating Curve

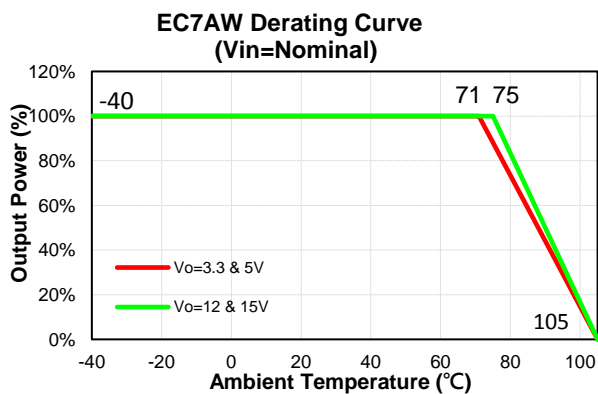



EC7AW Series

Performance Data

EC7AW-24S33
Eff Vs Io @25 Deg. C

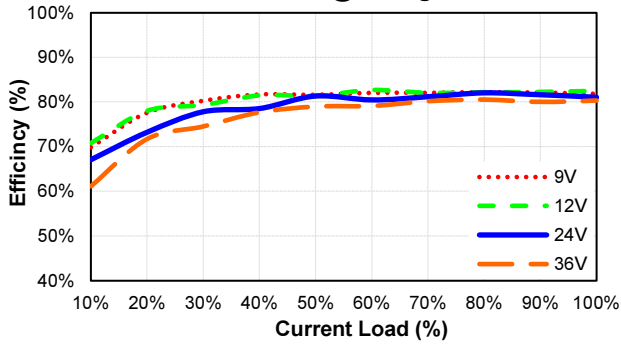

EC7AW-24S33
Pd Vs Po @25 Deg. C

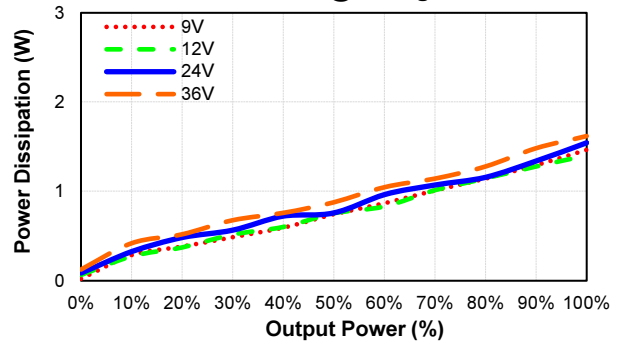

EC7AW-24S05
Eff Vs Io @25 Deg. C

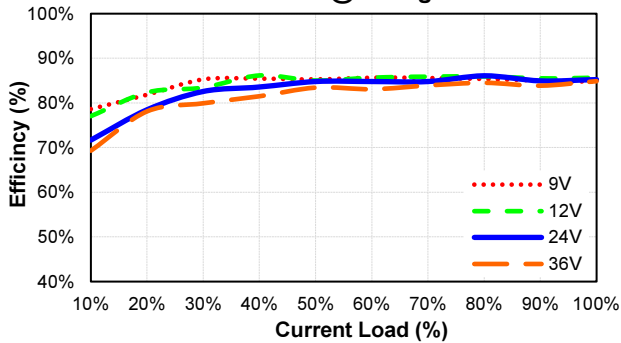

EC7AW-24S05
Pd Vs Po @25 Deg. C

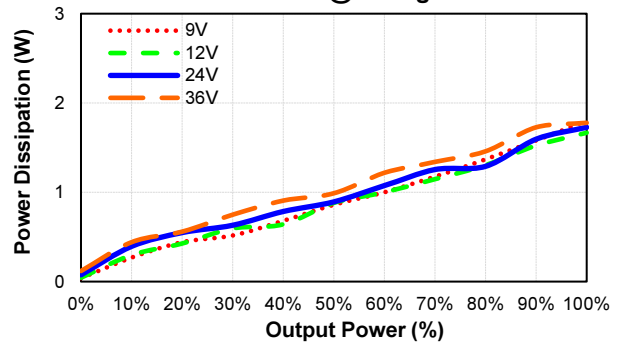

EC7AW-24S12
Eff Vs Io @25 Deg. C

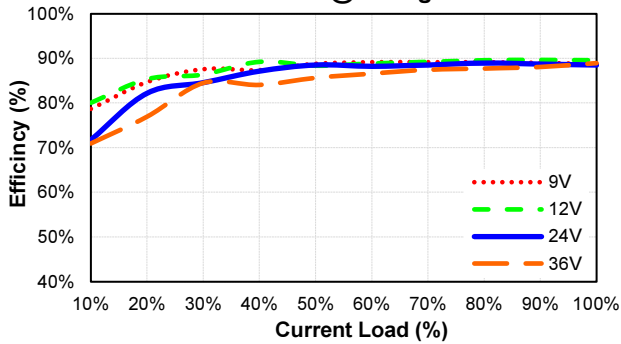

EC7AW-24S12
Pd Vs Po @25 Deg. C

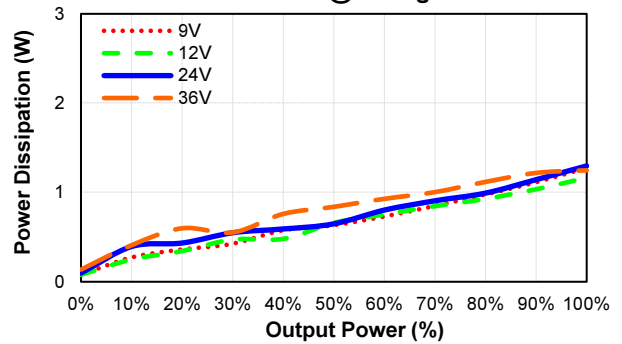

EC7AW-24S15
Eff Vs Io @25 Deg. C

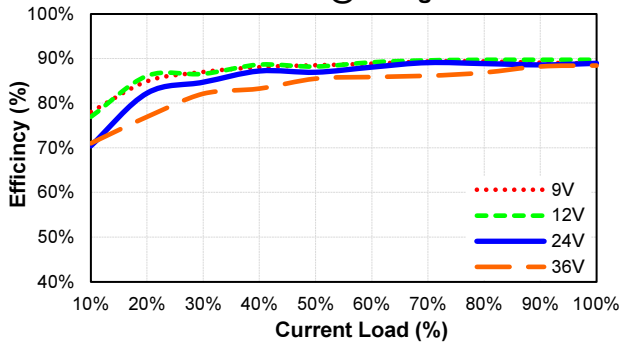

EC7AW-24S15
Pd Vs Po @25 Deg. C

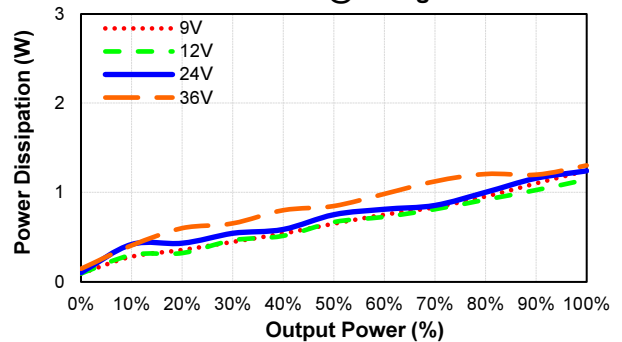



EC7AW Series

EC7AW-24D12
Eff Vs Io @25 Deg. C

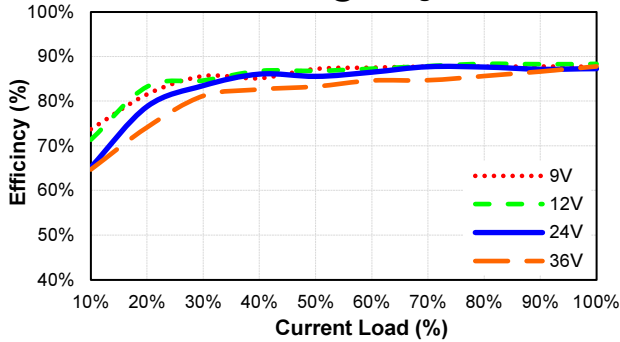

EC7AW-24D12
Pd Vs Po @25 Deg. C

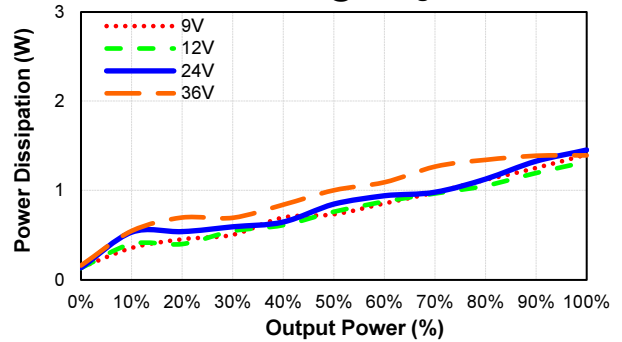

EC7AW-24D15
Eff Vs Io @25 Deg. C

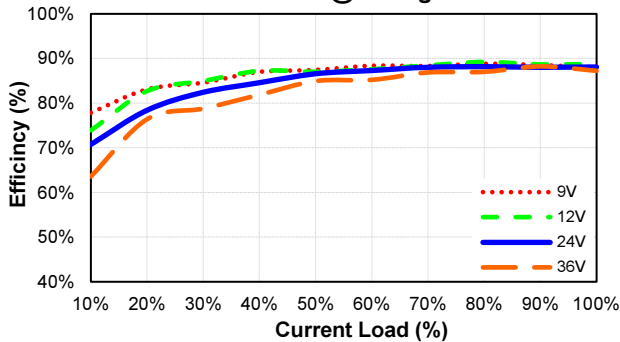

EC7AW-24D15
Pd Vs Po @25 Deg. C

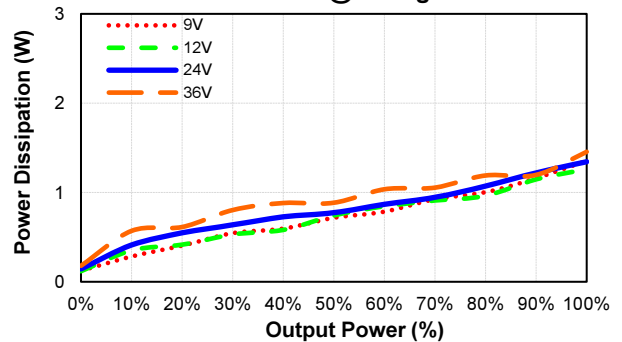

EC7AW-48S33
Eff Vs Io @25 Deg. C

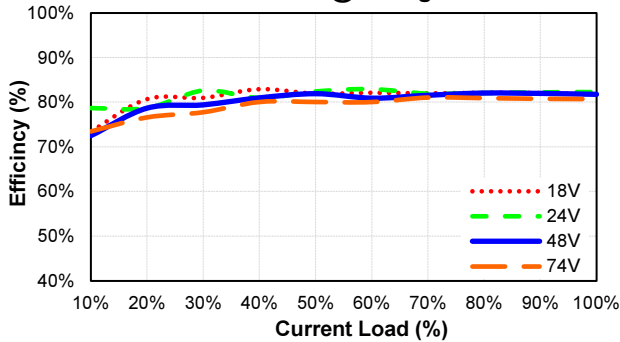

EC7AW-48S33
Pd Vs Po @25 Deg. C

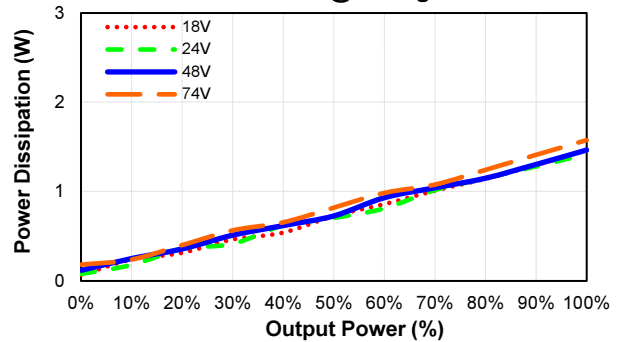

EC7AW-48S05
Eff Vs Io @25 Deg. C

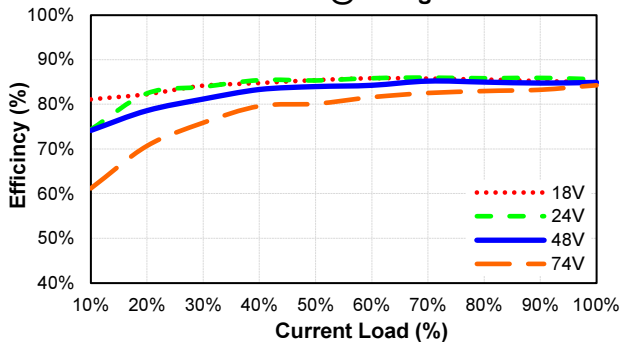

EC7AW-48S05
Pd Vs Po @25 Deg. C

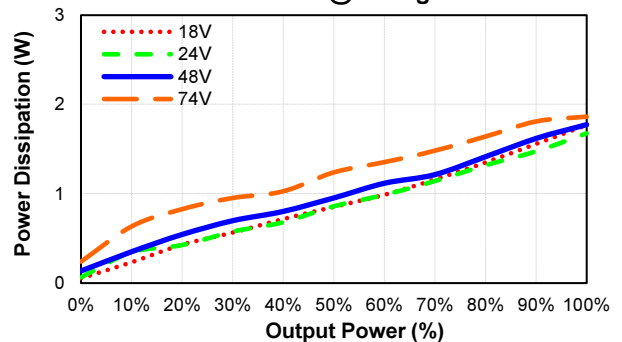



EC7AW Series

EC7AW-48S12
Eff Vs Io @25 Deg. C

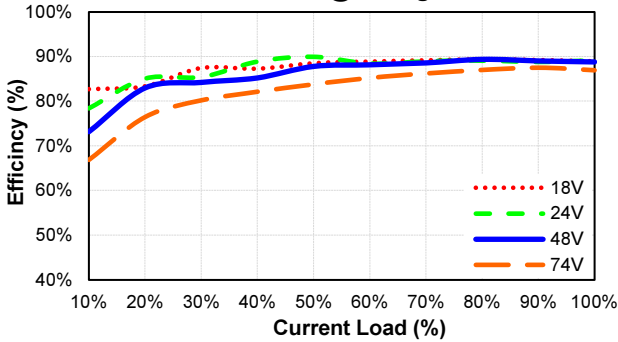

EC7AW-48S12
Pd Vs Po @25 Deg. C

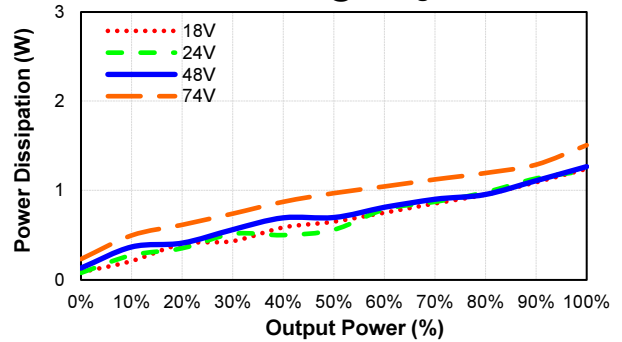

EC7AW-48S15
Eff Vs Io @25 Deg. C

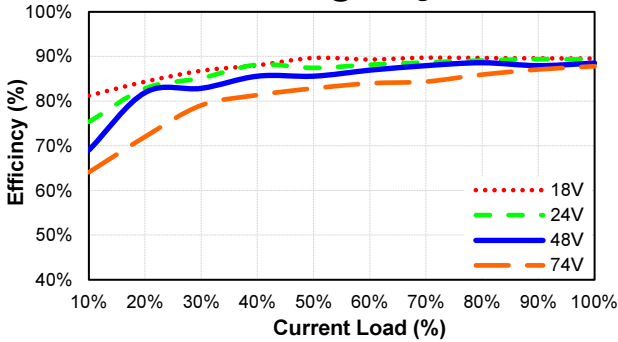

EC7AW-48S15
Pd Vs Po @25 Deg. C

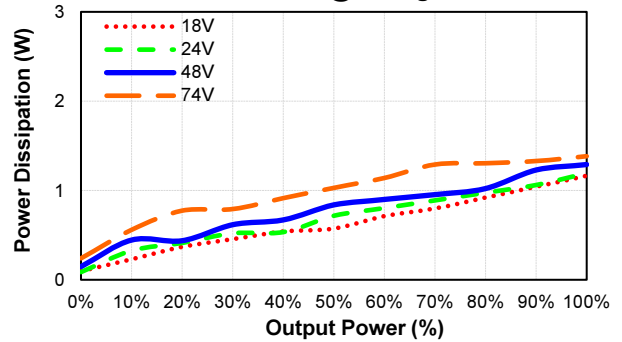

EC7AW-48D12
Eff Vs Io @25 Deg. C

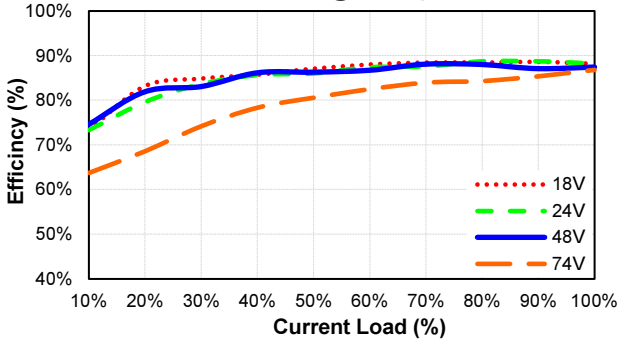

EC7AW-48D12
Pd Vs Po @25 Deg. C

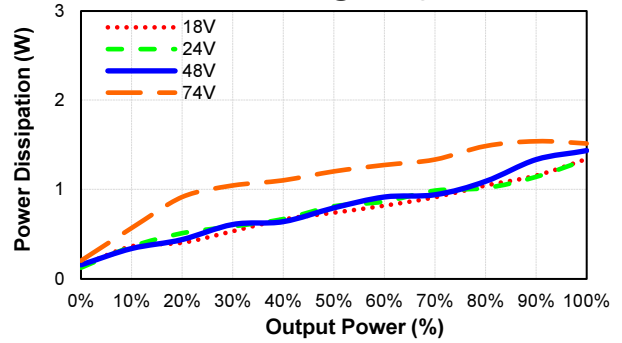

EC7AW-48D15
Eff Vs Io @25 Deg. C

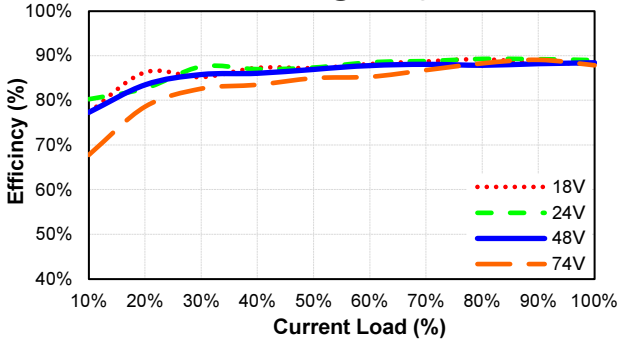

EC7AW-48D15
Pd Vs Po @25 Deg. C

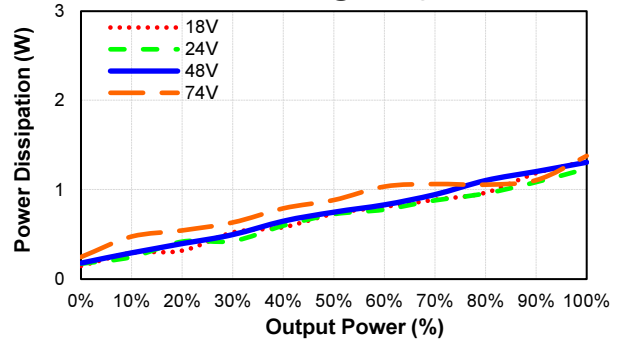



EC7AW Series

MECHANICAL SPECIFICATION

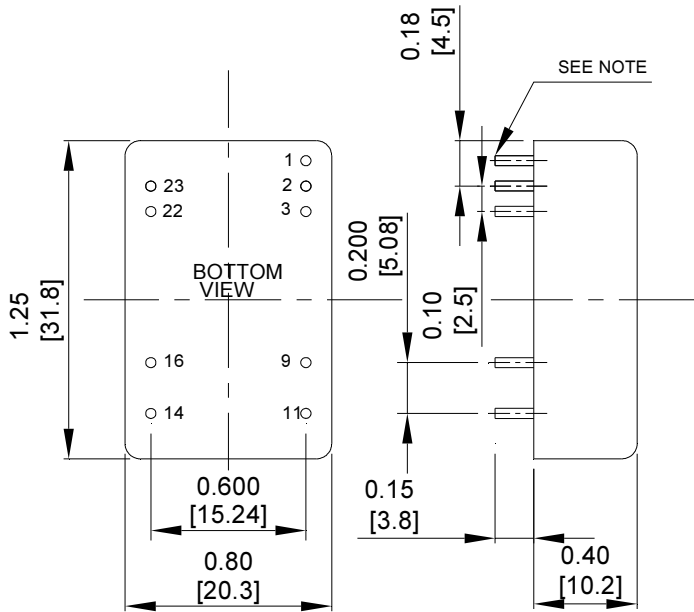

NOTE: Pin Size is 0.02±0.002 Inch (0.5±0.05 mm)DIA
 All Dimensions In Inches (mm)
 Tolerances Inches: X.XX= ±0.02 , X.XXX= ±0.010
 Millimeters: X.X= ±0.5 , X.XX=±0.25

PIN CONNECTION		
Pin	Single Output	Dual Output
1	Remote on/off	Remote on/off
2,3	-V Input	-V Input
9	NP	Common
11	NC	-V Output
14	+V Output	+V Output
16	-V Output	Common
22,23	+V Input	+V Input

* NC-NO CONNECTION WITH PIN
 * NP-NO PIN