



CYPRESS SEMICONDUCTOR

PALC22V10

Reprogrammable CMOS

PAL® Device

T-46-19-09

Features

- Advanced second-generation PAL architecture
- Low power
 - 55 mA max. "I"
 - 90 mA max. standard
 - 120 mA max. military
- CMOS EPROM technology for reprogrammability
- Variable product terms
 - 2 x (8 through 16) product terms
- User-programmable macrocell
 - Output polarity control
 - Individually selectable for registered or combinatorial operation
- 20, 25, 35 ns commercial and industrial
- 25, 30, 40 ns military

- Up to 22 input terms and 10 outputs
- High reliability
 - Proven EPROM technology
 - 100% programming and functional testing
- Windowed DIP, windowed LCC, DIP, LCC, and PLCC available

Functional Description

The Cypress PALC22V10 is a CMOS second-generation programmable logic array device. It is implemented with the familiar sum-of-products (AND-OR) logic structure and a new concept, the "programmable macrocell."

The PALC22V10 is available in 24-pin 300-mil molded DIPs, 300-mil windowed cerDIPs, 28-lead square ceramic leadless chip carriers, 28-lead square plastic leaded chip carriers, and provides up to

22 inputs and 10 outputs. When the windowed cerDIP is exposed to UV light, the 22V10 is erased and can then be reprogrammed. The programmable macrocell provides the capability of defining the architecture of each output individually. Each of the 10 potential outputs may be specified as registered or combinatorial. Polarity of each output may also be individually selected, allowing complete flexibility of output configuration. Further configurability is provided through array-configurable output enable for each potential output. This feature allows the 10 outputs to be reconfigured as inputs on an individual basis, or alternately used as a combination I/O controlled by the programmable array.



Logic Block Diagram (PDIP/CDIP)

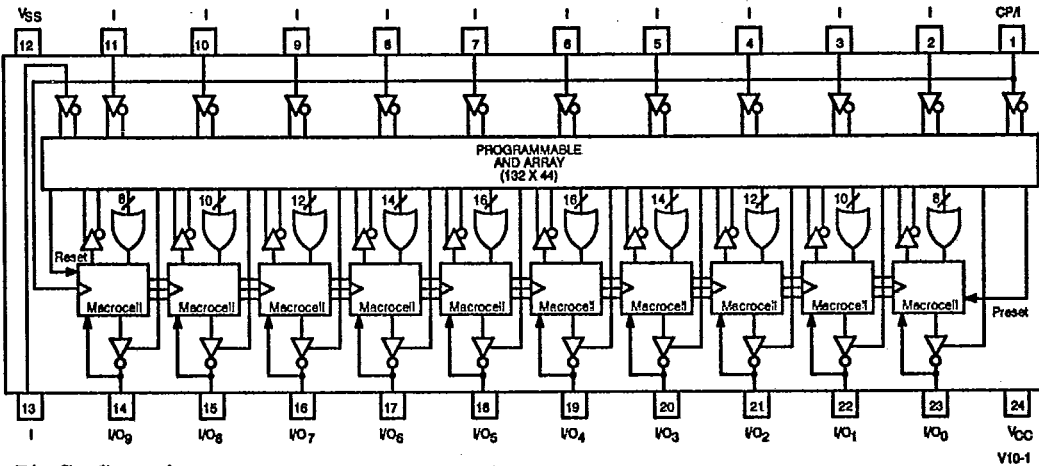

Pin Configuration

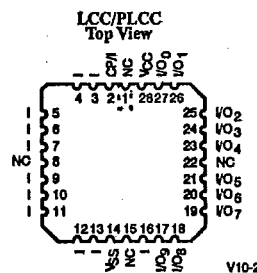

V10-2

PAL is a registered trademark of Monolithic Memories Inc.



Functional Description (continued)

PALC22V10 features a variable product term architecture. There are five pairs of product terms beginning at 8 product terms per output and incrementing by 2 to 16 product terms per output. By providing this variable structure, the PALC22V10 is optimized to the configurations found in a majority of applications without creating devices that burden the product term structures with unusable product terms and lower performance.

Additional features of the Cypress PALC22V10 include a synchronous preset and an asynchronous reset product term. These product terms are common to all macrocells, eliminating the need to dedicate standard product terms for initialization function. The device automatically resets on power-up.

For testing of programmed functions, a preload feature allows any or all of the registers to be loaded with an initial value for testing. This is accomplished by raising pin 8 to a supervoltage V_{pp} , which puts the output drivers in a high-impedance state. The data to be loaded is then placed on the I/O pins of the device and is loaded into the registers on the positive edge of the clock on pin 1. A 0 on the I/O pin preloads the register with a 0, and a 1 preloads the register with a 1. The actual signal on the output pin will be the inversion of the input data. The data on the I/O pins is then removed and pin 8 is returned to a normal TTL voltage. Again, care should be exercised to power sequence the device properly.

The PALC22V10 featuring programmable macrocells and variable product terms provides a device with the flexibility to implement logic functions in the 500 to 800 gate array complexity. Since each of the 10 output pins may be individually configured as inputs on a temporary or permanent basis, functions requiring up to 21 inputs and only a single output and down to 12 inputs and 10 outputs are possible. The 10 potential outputs are enabled using product terms. Any output pin may be permanently se-

lected as an output or arbitrarily enabled as an output and an input through the selective use of individual product terms associated with each output. Each of these outputs is achieved through an individual programmable macrocell. These macrocells are programmable to provide a combinatorial or registered inverting or non-inverting output. In a registered mode of operation, the output of the register is fed back into the array, providing current status information to the array. This information is available for establishing the next result in applications such as control state machines. In a combinatorial configuration, the combinatorial output or, if the output is disabled, the signal present on the I/O pin is made available to the array. The flexibility provided by both programmable macrocell product term control of the outputs and variable product terms allows a significant gain in functional density through the use of a programmable logic.

Along with this increase in functional density, the Cypress PALC22V10 provides lower-power operation through the use of CMOS technology and increased testability with a register preload feature. Preload facilitates testing programmed devices by loading initial values into the registers.

Configuration Table

Registered/Combinatorial		
C_1	C_0	Configuration
0	0	Registered/Active LOW
0	1	Registered/Active HIGH
1	0	Combinatorial/Active LOW
1	1	Combinatorial/Active HIGH

Macrocell

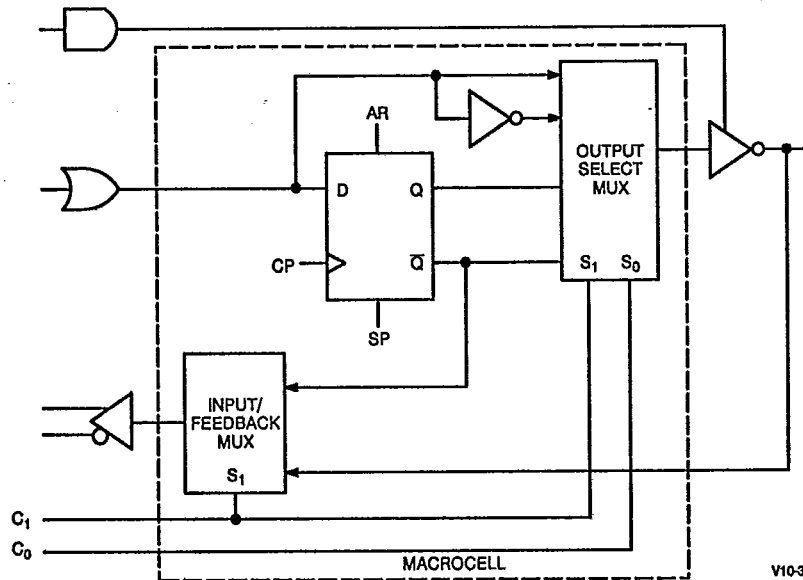



Selection Guide

Generic Part Number	I _{CC1} (mA)			t _{PD} (ns)		t _g (ns)		t _{CO} (ns)	
	"L"	Com/Ind	Mil	Com/Ind	Mil	Com/Ind	Mil	Com/Ind	Mil
22V10-20		90		20		12		12	
22V10-25	55	90	100	25	25	15	18	15	15
22V10-30			100		30		20		20
22V10-35	55	90		35		30		25	
22V10-40			100		40		30		25

Maximum Ratings

(Above which the useful life may be impaired. For user guidelines, not tested.)

Storage Temperature - 65°C to +150°C

Ambient Temperature with Power Applied - 55°C to +125°C

Supply Voltage to Ground Potential (Pin 24 to Pin 12) - 0.5V to +7.0V

DC Voltage Applied to Outputs in High Z State - 0.5V to +7.0V

DC Input Voltage - 3.0V to +7.0V

Output Current into Outputs (LOW) 16 mA

UV Exposure 7258 Wsec/cm²

DC Programming Voltage 14.0V

Latch-Up Current >200 mA

Operating Range

Range	Ambient Temperature	V _{CC}
Commercial	0°C to +75°C	5V ±10%
Industrial	- 40°C to +85°C	5V ±10%
Military ^[1]	- 55°C to +125°C	5V ±10%

Electrical Characteristics Over the Operating Range^[2]

Parameters	Description	Test Conditions	Min.	Max.	Units
V _{OH1}	Output HIGH Voltage	V _{CC} = Min., V _{IN} = V _{IH} or V _{IL} I _{OH} = - 3.2 mA Com'l/Ind I _{OH} = - 2 mA Mil	2.4		V
V _{OH2}	HIGH Level CMOS Output Voltage ^[3]	V _{CC} = Min., V _{IN} = V _{IH} or V _{IL} I _{OH} = - 100 µA	V _{CC} - 1.0V		V
V _{OL}	Output LOW Voltage	V _{CC} = Min., V _{IN} = V _{IH} or V _{IL} I _{OL} = 16 mA Com'l/Ind I _{OL} = 12 mA Mil		0.5	V
V _{IH}	Input HIGH Level	Guaranteed Input Logical HIGH Voltage for All Inputs ^[4]	2.0		V
V _{IL}	Input LOW Level	Guaranteed Input Logical LOW Voltage for All Inputs ^[4]		0.8	V
I _{Ix}	Input Leakage Current	V _{SS} ≤ V _{IN} ≤ V _{CC} , V _{CC} = Max.	- 10	+10	µA
I _{OZ}	Output Leakage Current	V _{CC} = Max., V _{SS} ≤ V _{OUT} ≤ V _{CC}	- 40	+40	µA
I _{SC}	Output Short Circuit Current	V _{CC} = Max., V _{OUT} = 0.5V ^[3,5]	- 30	- 90	mA
I _{CC1}	Standby Power Supply Current	V _{CC} = Max., V _{IN} = GND Outputs Open for Unprogrammed Device		55	mA
		"L"		90	mA
		Com'l/Ind		100	mA
		Mil		100	mA
I _{CC2}	Operating Power Supply Current	f _{toggle} = F _{MAX} ^[3]		65	mA
		"L"		65	mA

- Notes:
1. t_A is the "instant on" case temperature.
 2. See the last page of this specification for Group A subgroup testing information.
 3. Tested initially and after any design or process changes that may affect these parameters.
 4. These are absolute values with respect to device ground. All overshoots due to system or tester noise are included.
 5. Not more than one output should be tested at a time. Duration of the short circuit should not be more than one second. V_{OUT} = 0.5V has been chosen to avoid test problems caused by tester ground degradation.

Capacitance^[3]

Parameters	Description	Test Conditions	Min.	Max.	Units
C _{IN}	Input Capacitance	V _{IN} = 2.0V @ f = 1 MHz		10	pF
C _{OUT}	Output Capacitance	V _{OUT} = 2.0V @ f = 1 MHz		10	pF

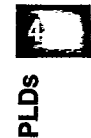

Switching Characteristics PALC22V10 (Commercial and Industrial)^[2, 6]

Parameters	Description	Commercial & Industrial						Units
		-20		-25		-35		
		Min.	Max.	Min.	Max.	Min.	Max.	
t _{PD}	Input to Output Propagation Delay ^[7]		20		25		35	ns
t _{EA}	Input to Output Enable Delay		20		25		35	ns
t _{ER}	Input to Output Disable Delay ^[8]		20		25		35	ns
t _{CO}	Clock to Output Delay ^[9]		12		15		25	ns
t _S	Input or Feedback Set-Up Time	12		15		30		ns
t _H	Input Hold Time	0		0		0		ns
t _P	External Clock Period (t _{CO} + t _S)	24		30		55		ns
t _{WH}	Clock Width HIGH ^[3]	10		12		17		ns
t _{WL}	Clock Width LOW ^[3]	10		12		17		ns
f _{MAX1}	External Maximum Frequency (1/(t _{CO} + t _S)) ^[10]	41.6		33.3		18.1		MHz
f _{MAX2}	Data Path Maximum Frequency (1/(t _{WH} + t _{WL})) ^[3, 11]	50.0		41.6		29.4		MHz
f _{MAX3}	Internal Feedback Maximum Frequency (1/(t _{CF} + t _S)) ^[12]	45.4		35.7		20.8		MHz
t _{CF}	Register Clock to Feedback Input ^[13]		10		13		18	ns
t _{AW}	Asynchronous Reset Width	20		25		35		ns
t _{AR}	Asynchronous Reset Recovery Time	20		25		35		ns
t _{AP}	Asynchronous Reset to Registered Output Delay		25		25		35	ns
t _{SPR}	Synchronous Preset Recovery Time	20		25		35		ns
t _{PR}	Power-Up Reset Time ^[14]	1.0		1.0		1.0		μs

Notes:

- Part (a) of AC Test Loads and Waveforms used for all parameters except t_{EA}, t_{ER}, t_{PZX}, and t_{PXZ}. Part (b) of AC Test Loads and Waveforms used for t_{EA}, t_{ER}, t_{PZX}, and t_{PXZ}.
- This specification is guaranteed for all device outputs changing state in a given access cycle. See part (d) of AC Test Loads and Waveforms for the minimum guaranteed negative correction which may be subtracted from t_{PD} for cases in which fewer outputs are changing state per access cycle.
- This parameter is specified as the time after output disable input during which the previous output data state remains stable on the output. This delay is measured to the point at which a previous HIGH level has fallen to 0.5V below V_{OH} min. or a previous LOW level has risen to 0.5V above V_{OL} max. Please see part (e) of AC Test Loads and Waveforms for enable and disable test waveforms and measurement reference levels.
- This specification is guaranteed for all device outputs changing state in a given access cycle. See part (d) of AC Test Loads and Waveforms for the minimum guaranteed negative correction that may be subtracted from t_{CO} for cases in which fewer outputs are changing state per access cycle.
- This specification indicates the guaranteed maximum frequency at which a state machine configuration with external feedback can operate.
- This specification indicates the guaranteed maximum frequency at which an individual output register can be cycled.
- This specification indicates the guaranteed maximum frequency at which a state machine configuration with internal only feedback can operate. This parameter is tested periodically by sampling production product.
- This parameter is calculated from the clock period at f_{MAX} internal (1/f_{MAX3}) as measured (see Note 11 above) minus t_S.
- The registers in the PALC22V10 have been designed with the capability to reset during system power-up. Following power-up, all registers will be reset to a logic LOW state. The output state will depend on the polarity of the output buffer. This feature is useful in establishing state machine initialization. To insure proper operation, the rise in V_{CC} must be monotonic and the timing constraints depicted in Power-Up Reset Waveform must be satisfied.



T-46-19-09

PALC22V10

Switching Characteristics PALC22V10 (Military)^[2, 6]

Parameters	Description	Military						Units
		-25		-30		-40		
		Min.	Max.	Min.	Max.	Min.	Max.	
t _{PD}	Input to Output Propagation Delay ^[6]		25		30		40	ns
t _{EA}	Input to Output Enable Delay		25		25		40	ns
t _{ER}	Input to Output Disable Delay ^[7]		25		25		40	ns
t _{CO}	Clock to Output Delay ^[9]		15		20		25	ns
t _S	Input or Feedback Set-Up Time	18		20		30		ns
t _H	Input Hold Time	0		0		0		ns
t _p	External Clock Period (t _{CO} + t _S)	33		40		55		ns
t _{WH}	Clock Width HIGH ^[3]	14		16		22		ns
t _{WL}	Clock Width LOW ^[3]	14		16		22		ns
f _{MAX1}	External Maximum Frequency (1/(t _{CO} + t _S)) ^[9]	30.3		25.0		18.1		MHz
f _{MAX2}	Data Path Maximum Frequency (1/(t _{WH} + t _{WL})) ^[3, 10]	35.7		31.2		22.7		MHz
f _{MAX3}	Internal Feedback Maximum Frequency (1/(t _{CF} + t _S)) ^[11]	32.2		28.5		20.0		MHz
t _{CF}	Register Clock to Feedback Input ^[12]		13		15		20	ns
t _{AW}	Asynchronous Reset Width	25		30		40		ns
t _{AR}	Asynchronous Reset Recovery Time	25		30		40		ns
t _{AP}	Asynchronous Reset to Registered Output Delay		25		30		40	ns
t _{SPR}	Synchronous Preset Recovery Time	25		30		40		ns
t _{PR}	Power-Up Reset Time ^[13]	1.0		1.0		1.0		μs



AC Test Loads and Waveforms

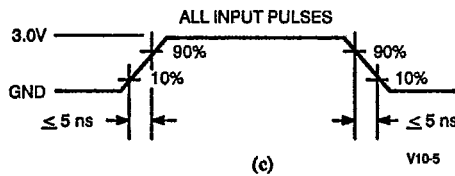
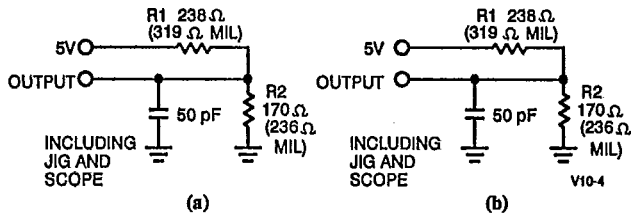

Equivalent to: THEVENIN EQUIVALENT (Commercial)

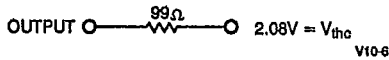

Equivalent to: THEVENIN EQUIVALENT (Military)

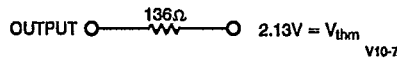



AC Test Loads and Waveforms (continued)

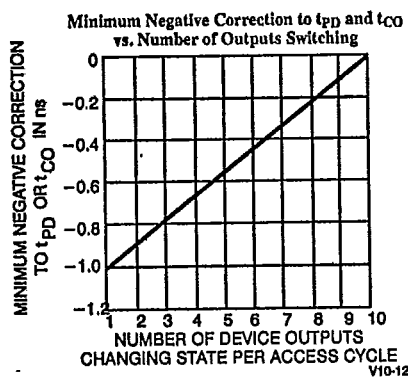

Parameter	V_X	Output Waveform—Measurement Level
$t_{ER}(-)$	1.5V	V10-8
$t_{ER}(+)$	2.6V	V10-9
$t_{EA}(+)$	V_{thc}	V10-10
$t_{EA}(-)$	V_{thc}	V10-11

(e) Test Waveforms

Switching Waveform

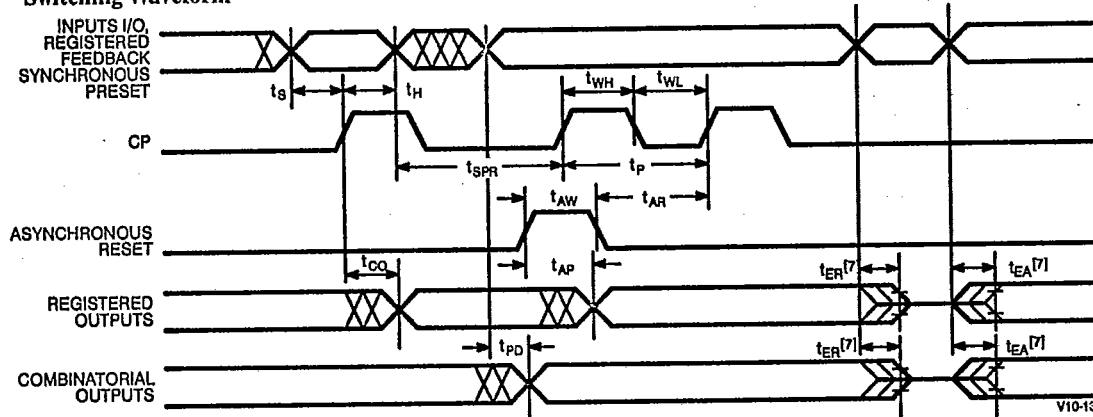

Power-Up Reset Waveform^[13, 15]

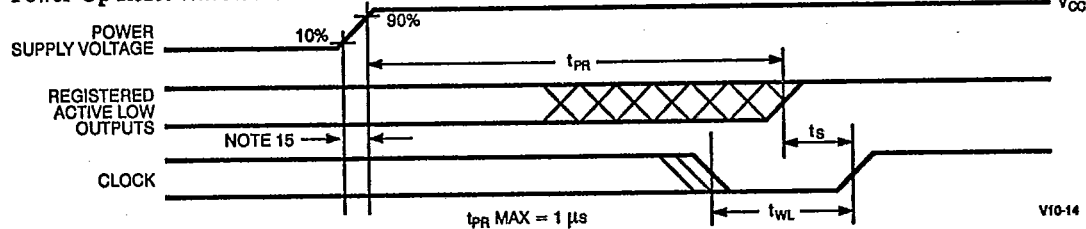

Notes:

15. The clock signal input must be in a valid LOW state (V_{IN} less than 0.8V) or a valid HIGH state (V_{IN} greater than 2.4V) prior to occurrence of the 10% level on the monotonically rising power supply voltage as shown in Power-Up Reset Waveform. In addition, the clock input signal must remain stable in that valid state as indicated until the

90% level on the power supply voltage has been reached. The clock signal may transition LOW to HIGH to clock in new data or to execute a synchronous preset after the indicated delay ($t_{PR} + t_S$) has been observed.



T-46-19-09

PALC22V10

Functional Logic Diagram for PALC22V10

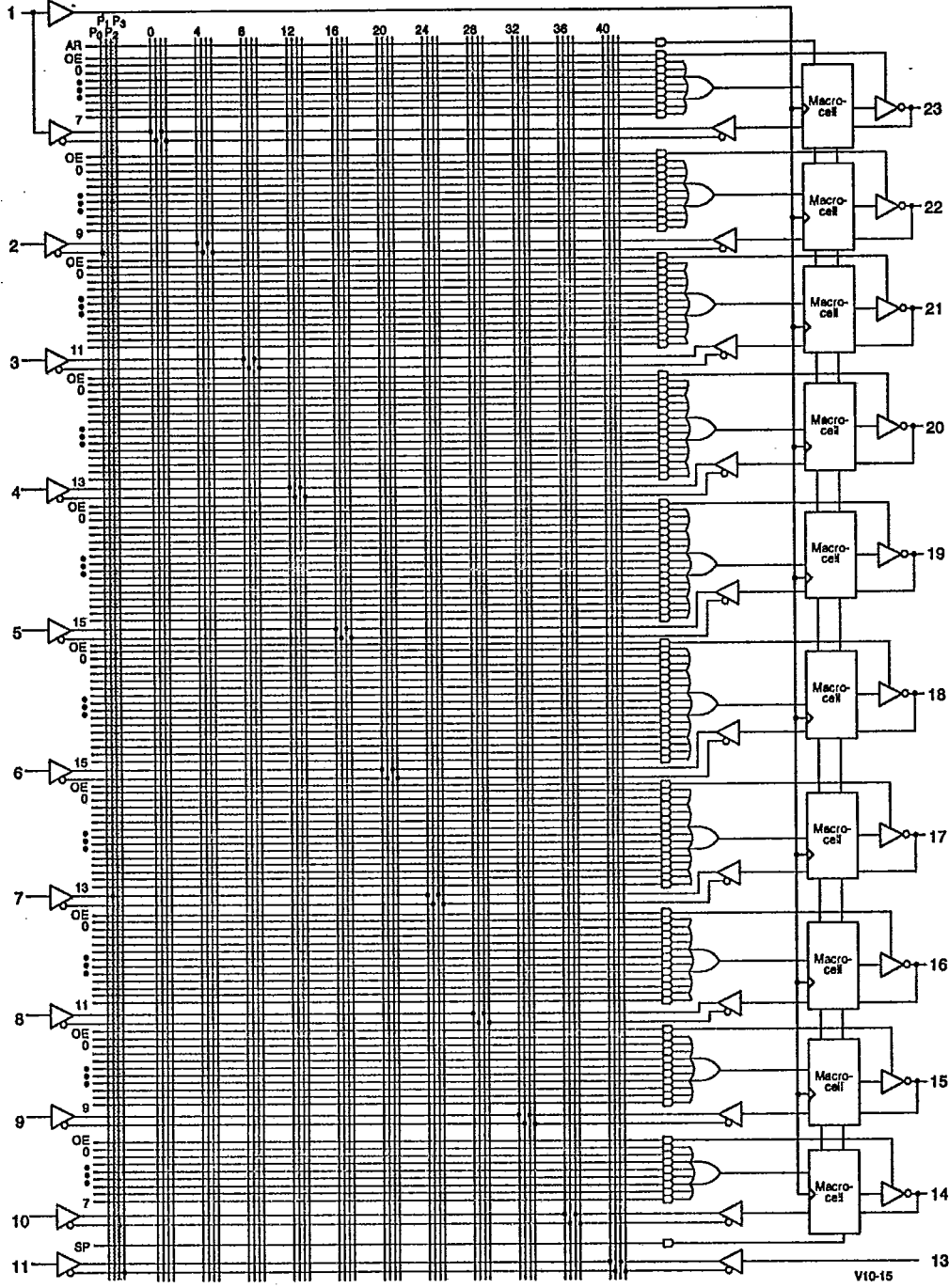



Typical DC and AC Characteristics

T-46-19-09

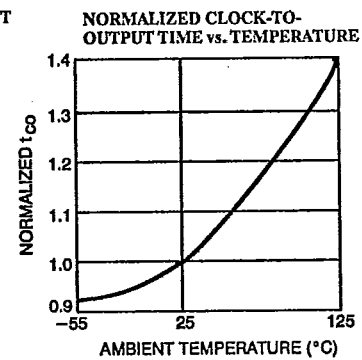
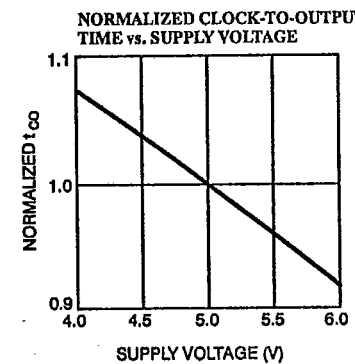
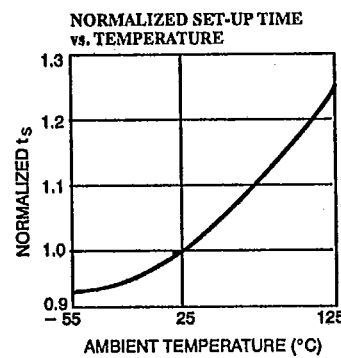
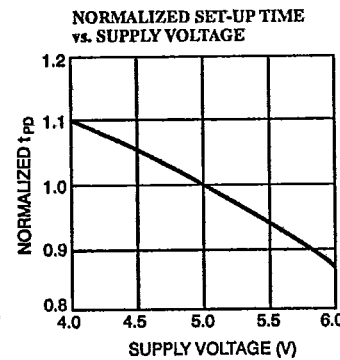
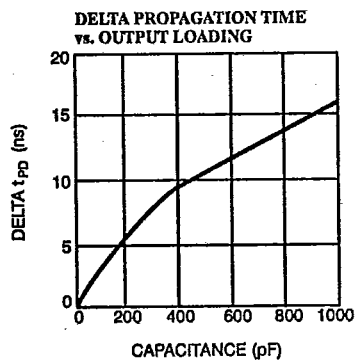
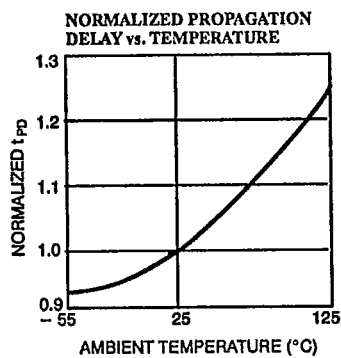
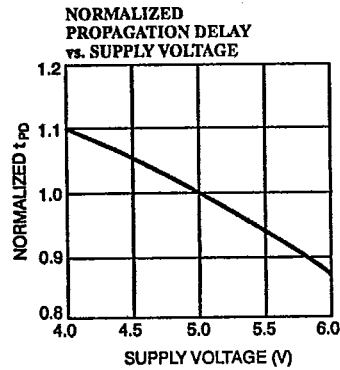
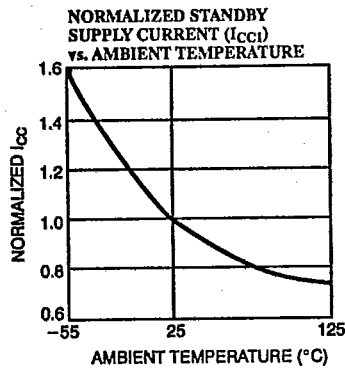
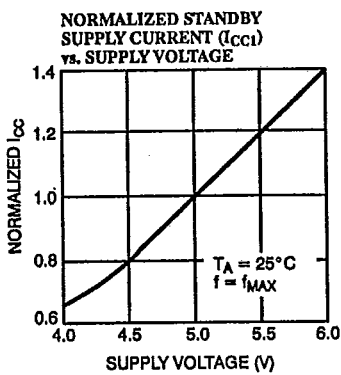

V10-16



PALC22V10

T-46-19-09

Typical DC and AC Characteristics (continued)

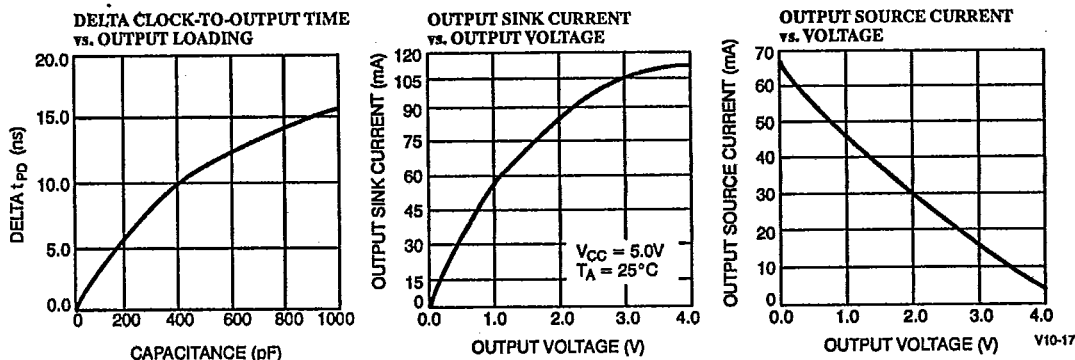

Erasure Characteristics

Wavelengths of light less than 4000Å begin to erase the PALC22V10. For this reason, an opaque label should be placed over the window if the device is exposed to sunlight or fluorescent lighting for extended periods of time. In addition, high-ambient light levels can create hole-electron pairs that may cause blank check failures or verify errors when programming windowed parts. This phenomenon can be avoided by placing an opaque label over the window during programming in high-ambient light environments.

The recommended dose for erasure is ultraviolet light with a wavelength of 2537Å for a minimum dose (UV intensity multiplied by exposure time) of 25 Wsec/cm². For an ultraviolet lamp with a 12 mW/cm² power rating, the exposure would be approximately 35 minutes. The PALC22V10 needs to be placed within one inch of the lamp during erasure. Permanent damage may result if the device is exposed to high-intensity UV light for an extended period of time. 7258 Wsec/cm² is the recommended maximum dosage.

Ordering Information 22V10

I _{CC} (mA)	t _{PD} (ns)	t _S (ns)	t _{CO} (ns)	Ordering Code	Package Type	Operating Range
90	20	12	12	PALC22V10-20HC	H64	Commercial/Industrial
				PALC22V10-20JC/JI	J64	
				PALC22V10-20PC/PI	P13	
				PALC22V10-20WC/WI	W14	
55	25	15	15	PALC22V10L-25HC	H64	Commercial
				PALC22V10L-25JC	J64	
				PALC22V10L-25PC	P13	
				PALC22V10L-25WC	W14	
90	25	15	15	PALC22V10-25HC	H64	Commercial/Industrial
				PALC22V10-25JC/JI	J64	
				PALC22V10-25PC/PI	P13	
				PALC22V10-25WC/WI	W14	
100	25	18	15	PALC22V10-25DMB	D14	Military
				PALC22V10-25HMB	H64	
				PALC22V10-25KMB	K73	
				PALC22V10-25LMB	L64	
				PALC22V10-25QMB	Q64	
				PALC22V10-25WMB	W14	



T-46-19-09

PALC22V10

Ordering Information 22V10 (Continued)

I _{CC} (mA)	t _{PD} (ns)	t _S (ns)	t _{CO} (ns)	Ordering Code	Package Type	Operating Range
100	30	20	20	PALC22V10-30DMB	D14	Military
				PALC22V10-30HMB	H64	
				PALC22V10-30KMB	K73	
				PALC22V10-30LMB	L64	
				PALC22V10-30QMB	Q64	
				PALC22V10-30WMB	W14	
55	35	30	25	PALC22V10L-35HC	H64	Commercial
				PALC22V10L-35JC	J64	
				PALC22V10L-35PC	P13	
				PALC22V10L-35WC	W14	
90	35	30	25	PALC22V10-35HC	H64	Commercial/Industrial
				PALC22V10-35JC/JI	J64	
				PALC22V10-35PC/PI	P13	
				PALC22V10-35WC/WI	W14	
100	40	30	25	PALC22V10-40DMB	D14	Military
				PALC22V10-40HMB	H64	
				PALC22V10-40KMB	K73	
				PALC22V10-40LMB	L64	
				PALC22V10-40QMB	Q64	
				PALC22V10-40WMB	W14	

MILITARY SPECIFICATIONS

Group A Subgroup Testing

DC Characteristics

Parameters	Subgroups
V _{OH}	1, 2, 3
V _{OL}	1, 2, 3
V _{IH}	1, 2, 3
V _{IL}	1, 2, 3
I _{Ix}	1, 2, 3
I _{OZ}	1, 2, 3
I _{CC}	1, 2, 3

Switching Characteristics

Parameters	Subgroups
t _{PD}	7, 8, 9, 10, 11
t _{CO}	7, 8, 9, 10, 11
t _S	7, 8, 9, 10, 11
t _H	7, 8, 9, 10, 11

Document #: 38-00020-F