

# 1 AMP ULTRAFAST RECOVERY DIODES

## FEATURES

- PROPRIETARY **SOFT GLASS<sup>®</sup>** JUNCTION PASSIVATION FOR SUPERIOR RELIABILITY AND PERFORMANCE
- VOID FREE VACUUM DIE SOLDERING FOR MAXIMUM MECHANICAL STRENGTH AND HEAT DISSIPATION (Solder Voids: Typical  $\leq 2\%$ , Max.  $\leq 10\%$  of Die Area)
- LOW SWITCHING NOISE
- LOW THERMAL RESISTANCE
- HIGH SWITCHING CAPABILITY
- LOW FORWARD VOLTAGE DROP

## MECHANICAL DATA

- Case: JEDEC DO-41 molded epoxy (U/L Flammability Rating 94V-0)
- Terminals: Plated axial leads
- Solderability: Per MIL-STD 202 Method 208 guaranteed
- Polarity: Color band denotes cathode
- Mounting Position: Any
- Weight: 0.013 Ounces (0.35 Grams)

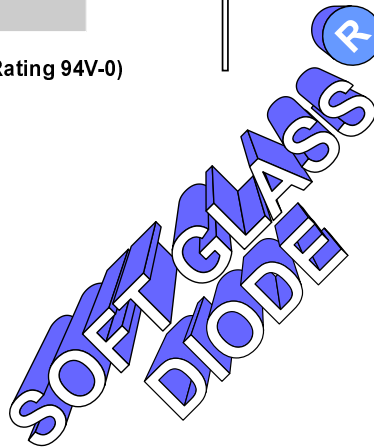

## MECHANICAL SPECIFICATION

ACTUAL SIZE OF DO-41 PACKAGE

SERIES UFR100 - UFR110

DO - 41

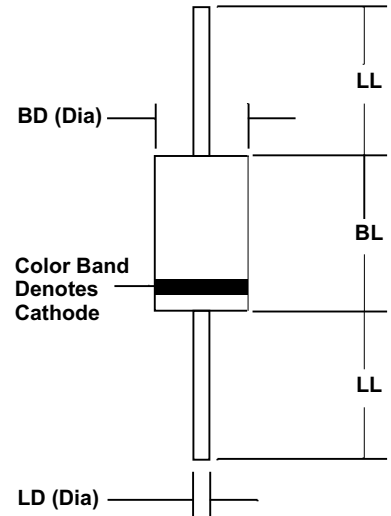

Sym	Minimum		Maximum	
	In	mm	In	mm
BL	0.160	4.1	0.205	5.2
BD	0.103	2.6	0.107	2.7
LL	1.00	25.4		
LD	0.028	0.71	0.034	0.86

## MAXIMUM RATINGS & ELECTRICAL CHARACTERISTICS

Ratings at 25 °C ambient temperature unless otherwise specified.  
 Single phase, half wave, 60Hz, resistive or inductive load.  
 For capacitive loads, derate current by 20%.

PARAMETER (TEST CONDITIONS)	SYMBOL	RATINGS										UNITS
		UFR 100	UFR 101	UFR 102	UFR 103	UFR 104	UFR 105	UFR 106	UFR 108	UFR 110		
Series Number												
Maximum DC Blocking Voltage	V <sub>RM</sub>	50	100	200	300	400	500	600	800	1000		
Maximum RMS Voltage	V <sub>RMS</sub>	35	70	140	210	280	350	420	560	700	VOLTS	
Maximum Peak Recurrent Reverse Voltage	V <sub>RRM</sub>	50	100	200	300	400	500	600	800	1000		
Average Forward Rectified Current @ T <sub>A</sub> = 55 °C	I <sub>O</sub>	1										AMPS
Peak Forward Surge Current ( 8.3mS single half sine wave superimposed on rated load)	I <sub>FSM</sub>	35										
Maximum Forward Voltage at 1 Amp DC	V <sub>FM</sub>	1.25					1.7					VOLTS
Maximum Average DC Reverse Current @ T <sub>C</sub> = 25 °C	I <sub>RM</sub>	2.0										μA
At Rated DC Blocking Voltage @ T <sub>C</sub> = 125 °C		50										
Typical Thermal Resistance, Junction to Ambient	R <sub>θJA</sub>	50										°C/W
Typical Junction Capacitance (Note 1)	C <sub>J</sub>	15										pF
Maximum Reverse Recovery Time (I <sub>F</sub> =0.5A, I <sub>R</sub> =1A, I <sub>RR</sub> =0.25A)	T <sub>RR</sub>	50					75					nSec
Junction Operating and Storage Temperature Range	T <sub>J</sub> , T <sub>STG</sub>	-65 to +150										°C

NOTES: (1) Measured at 1 MHz and an applied reverse voltage of 4 volts.

3.01 UFR100

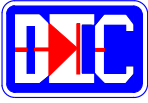

# 1 AMP ULTRAFAST RECOVERY DIODES

## RATING & CHARACTERISTIC CURVES FOR SERIES UFR100 - UFR110

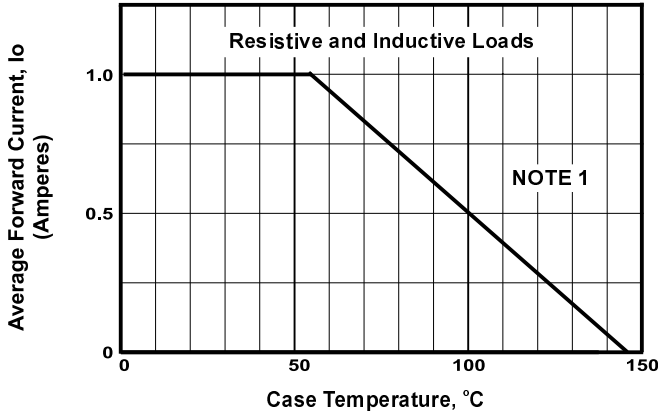

FIGURE 1. FORWARD CURRENT DERATING CURVE

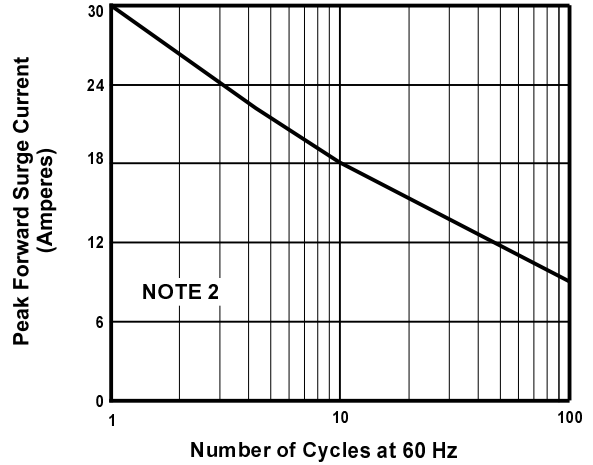

FIGURE 2. MAXIMUM NON-REPETITIVE SURGE CURRENT

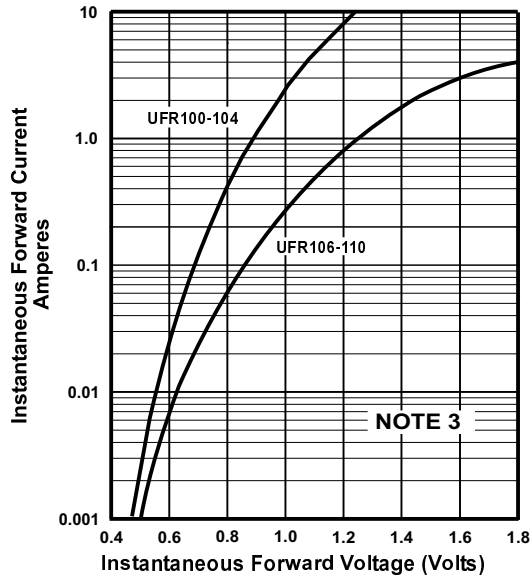

FIGURE 3. TYPICAL FORWARD CHARACTERISTICS

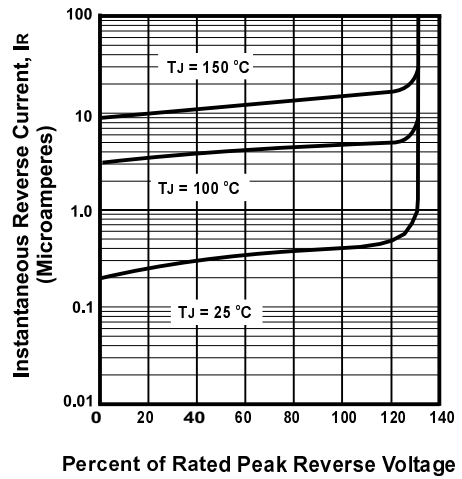

FIGURE 4. TYPICAL REVERSE CHARACTERISTICS

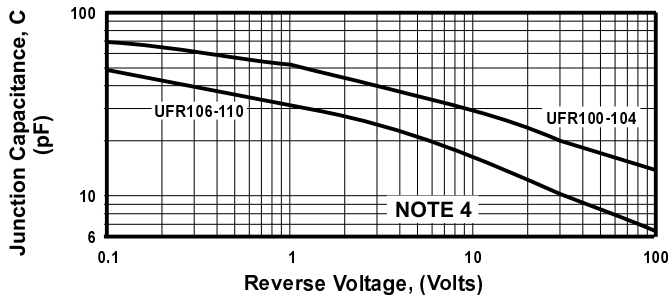

FIGURE 5. TYPICAL JUNCTION CAPACITANCE

### NOTES

- (1) Single Phase, Half Wave, 60 Hz; Lead Length = 0.375" (9.5mm)
- (2) JEDEC Method, 8.3 mSec. Single Half Sine Wave
- (3)  $T_J = 25^\circ\text{C}$ , Pulse Width = 300  $\mu\text{Sec}$ , 1.0% Duty Cycle
- (4)  $T_J = 25^\circ\text{C}$ ,  $f = 1.0\text{ MHz}$ , 2% Duty Cycle.