

## 4 Channel Low Capacitance ESD Protection Diode Array

HYESD0524 is a 4-channel ultra low capacitance ESD protection diode array which includes surge rated to protect high speed data lines. Each channel consists of a pair of ESD diodes that steer positive or negative ESD current to either the positive or negative rail. Typical application, the negative rail pin (Assigned as GND) is connected with system ground. The Positive ESD current is steered to the ground through an ESD diode and Zener diode and the positive ESD voltage is clamped to the zener voltage.

### FEATURES

- 4 Channel ESD protection for high speed data line
- Provides ESD protection to IEC61000-4-2 level 4
  - $\pm 17\text{KV}$  Air Discharge
  - $\pm 12\text{KV}$  Contact Discharge
- Ultra low capacitance
  - I/O to GND : 0.9pF ( Max )
  - I/O to I/O : 0.45pF ( Max )
- Low clamping voltage & 5V operation voltage

### APPLICATION

- HDMI / DVI ports
- Display port
- USB 2.0 port
- Flat panel Monitors / TVs
- Cellular Handsets & Accessories
- PCI Express
- Serial ATA

### MECHANICAL INFORMATION

- Case : SOT-23-6L / SOT-363-6L Package
- Pb-Free, Halogen Free, RoHS/WEEE Compliant

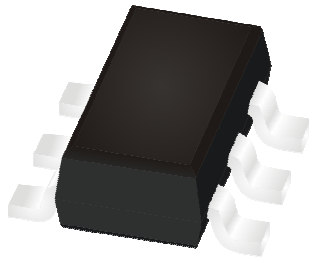

HYESD0524A6  
SOT-23-6L

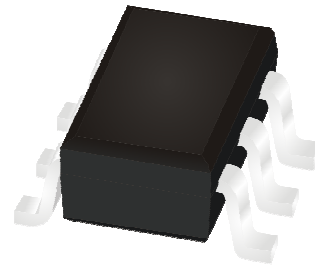

HYESD0524B6  
SOT-363-6L

### PIN CONFIGURATION

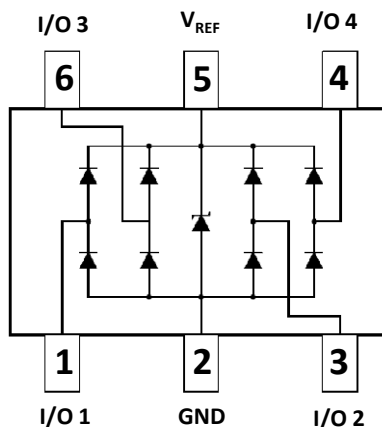

**Maximum Rating and Thermal Characteristics (  $T_C=25^\circ\text{C}$  )**

Parameter	Symbol	Value	Unit
Peak Pulse Power(8/20 $\mu\text{s}$ )	$P_{PP}$	150	W
Peak Pulse Current(8/20 $\mu\text{s}$ )	$I_{PP}$	5	A
ESD per IEC 61000-4-2(Air)	$V_{ESD}$	$\pm 17\text{KV}$	V
ESD per IEC 61000-4-2(Contact)	$V_{ESD}$	$\pm 12\text{KV}$	V
Operating Temperature Range	$T_{op}$	-55 to +125	$^\circ\text{C}$
Storage Temperature Range	$T_{stg}$	-55 to +150	$^\circ\text{C}$

**Electrical Characteristics (  $T_C=25^\circ\text{C}$ , unless otherwise noted )**

Parameter	Symbol	Test Condition	Min	Typ	Max	Unit
Reverse Working Voltage	$V_{RWM}$	Any I/O pin to GND	-	-	5	V
Reverse Breakdown Voltage	$V_{BR}$	$I_{BR}=1\text{mA}$ ; I/O pin to GND	6	-		V
Reverse Leakage Current	$I_R$	$V_{RWM}=5\text{V}$ , $T=25^\circ\text{C}$ ; I/O pin to GND	-	-	1	$\mu\text{A}$
Positive Clamping Voltage	$V_C$	$I_{PP}=1\text{A}$ , $t_p=8/20\mu\text{s}$ ; Positive pulse; Any I/O pin to GND	-	8.5	12	V
Negative Clamping Voltage	$V_C$	$I_{PP}=1\text{A}$ , $t_p=8/20\mu\text{s}$ ; Negative pulse; Any I/O pin to GND	-	1.8	-	V
Junction Capacitance Between Channel	$C_J$	$V_R=0\text{V}$ , $f=1\text{MHz}$ ; Between I/O pins	-	0.35	0.45	pF
Junction Capacitance Between I/O And GND	$C_J$	$V_R=0\text{V}$ , $f=1\text{MHz}$ ; Any I/O pin to GND	-	-	0.9	pF

**Typical Characteristic Curves (  $T_j=25^\circ\text{C}$ , UNLESS OTHERWISE NOTED )**

FIG.1 - Power Derating Curve

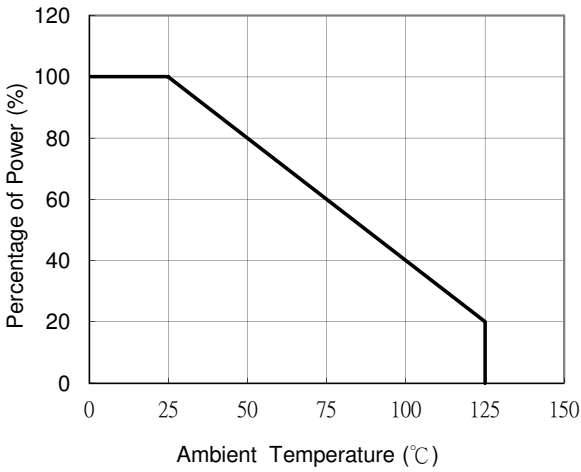

FIG.2 - Pulse Waveform

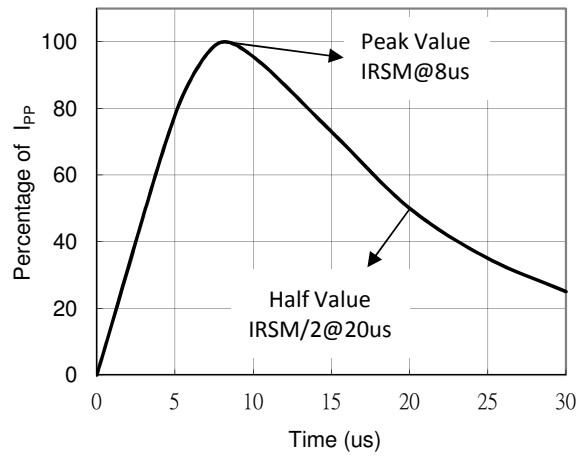

FIG.3 - Junction Capacitance vs. Reverse Voltage

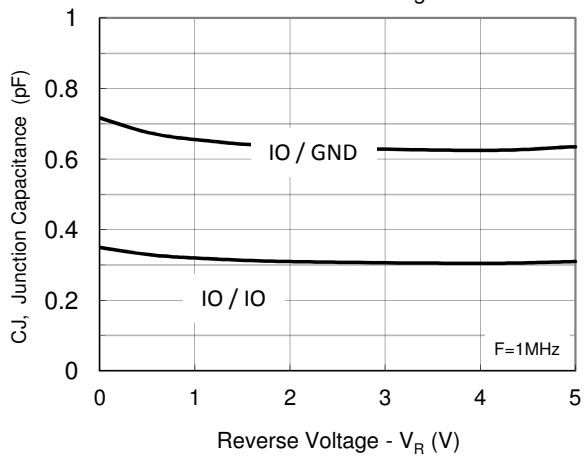
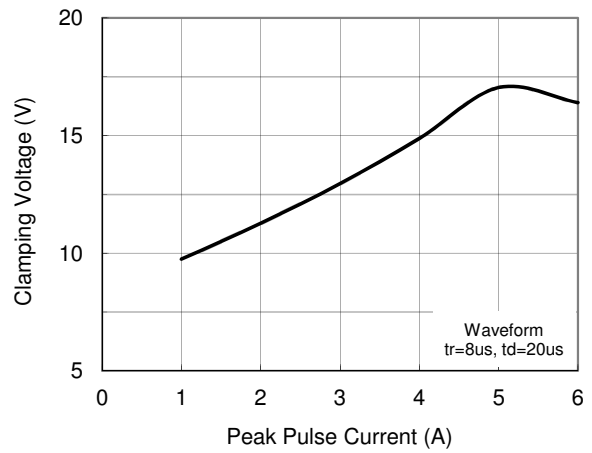

FIG.4 - Clamping Voltage vs. Peak Pulse Current



**Order & Marking Information**

Part Number	Package	Packing	Q'ty
HYESD0524A6	SOT-23-6L	7" Reel	3K
HYESD0524B6	SOT-363-6L	7" Reel	3K

**Package Outline Dimension**

**SOT-23-6L Package**

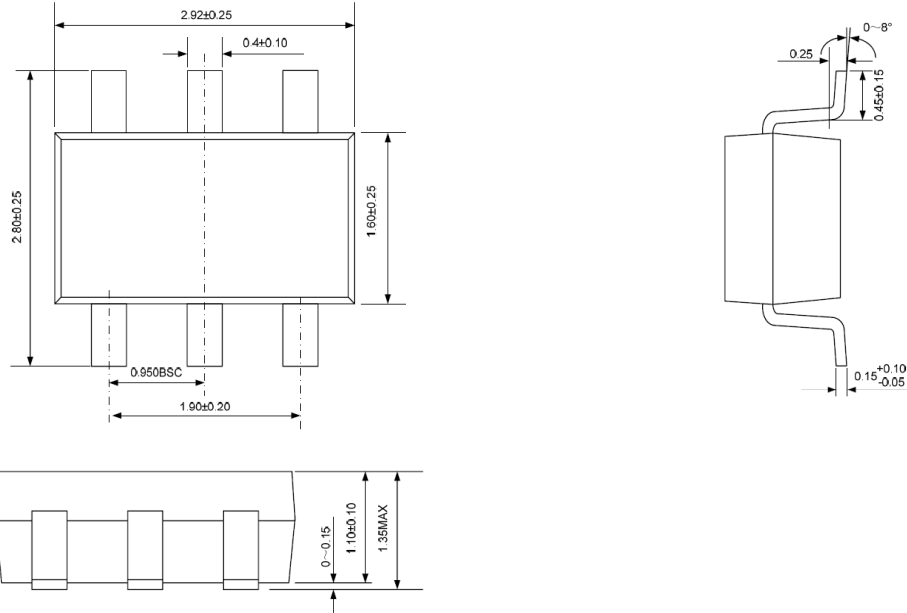

**SOT-363-6L Package**

