

KT15001AF1E

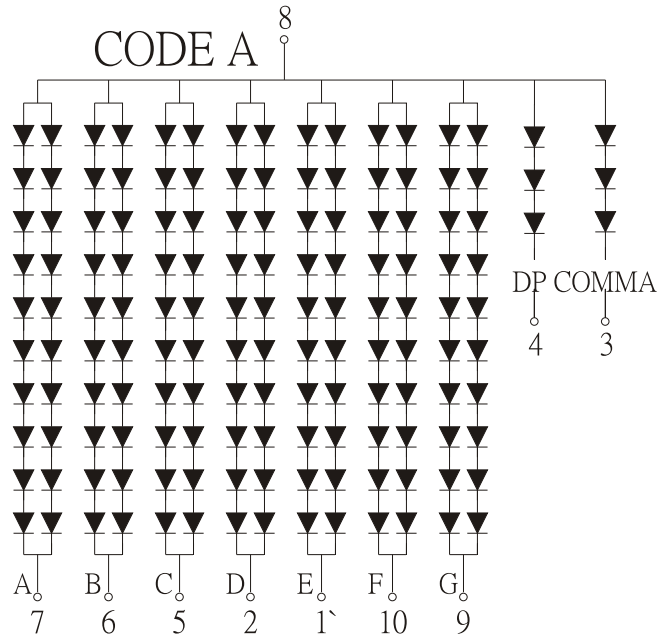
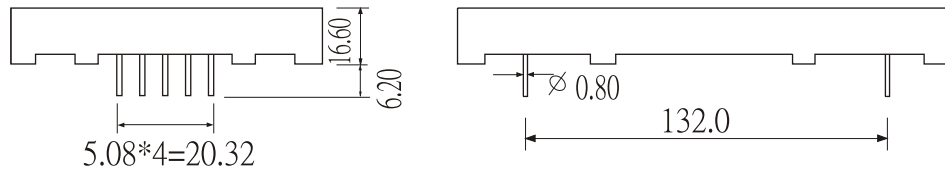
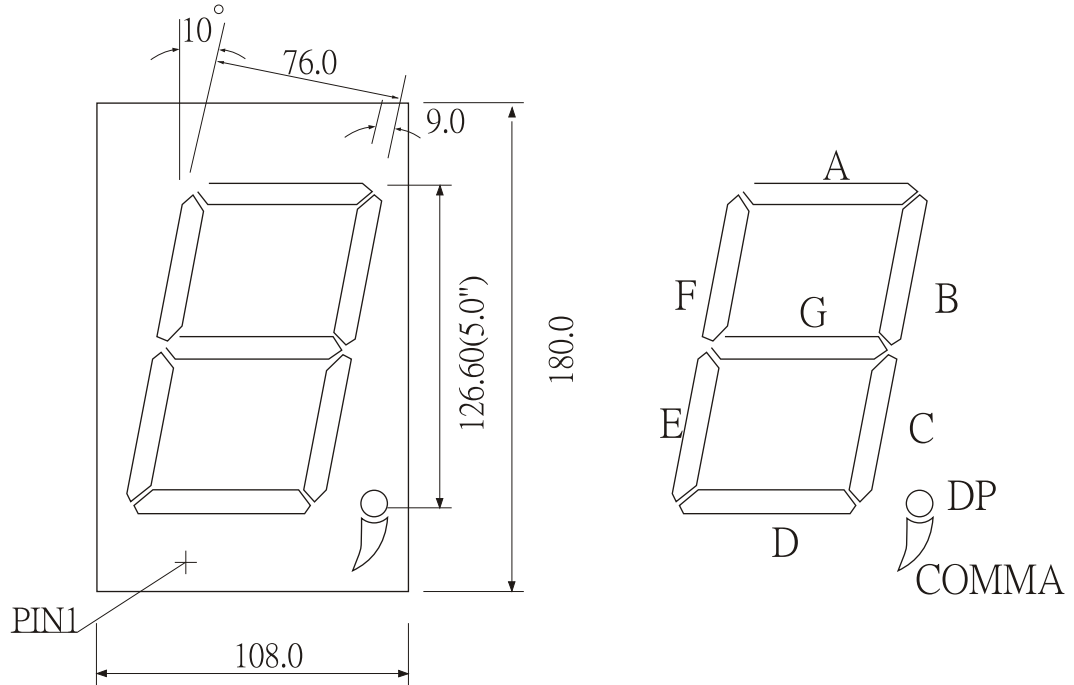

Fig. 1

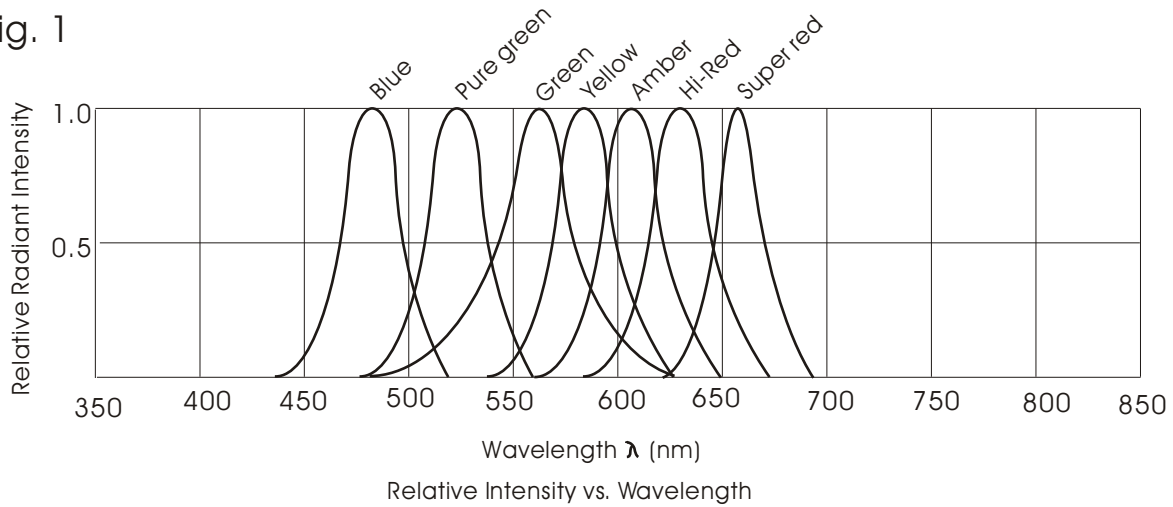
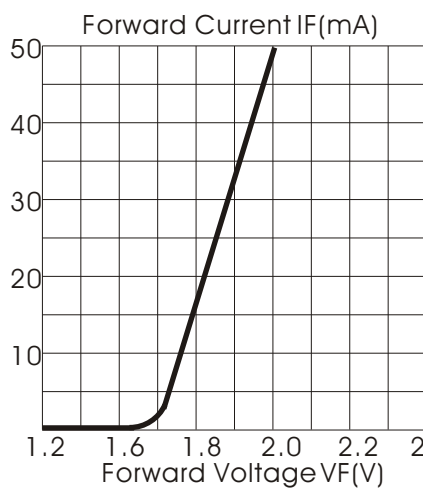
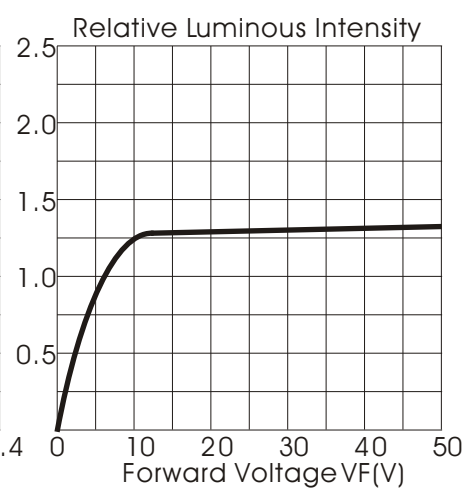

Fig. 2



Forward Current VS Forward Voltage.

Fig. 3



Relative Luminous Intensity VS. Forward Current

Fig. 4

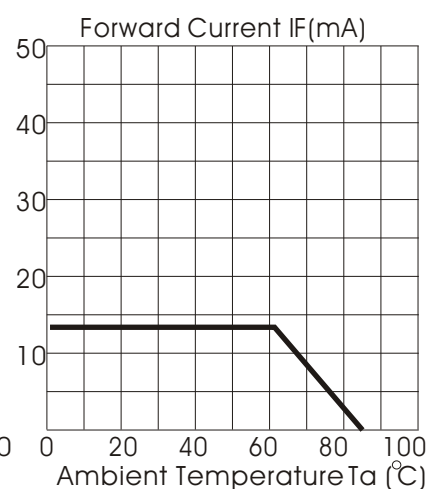

Ambient Temperature Ta (°C)

Code: F

Parameter	Symbol	Condition	Min	Typ	Max	Unit
Forward Voltage	Vf	If = 20uA	1.5	-	-	V
Reverse Voltage	Vr	Ir = 10uA	5	-	-	V
Luminous Intensity	Iv	If = 20mA		12		mcd
Spectrum Width Of Half Value	$\Delta\lambda$	If = 20mA		35		nm
Wavelength	Dλ	If = 20mA		628		nm

Absolute Maximum Rating at Ta = 25°C