



High Collector-emitter Voltage Type LTV702V

T41-83



■ FEATURES

1. High collector-emitter voltage ($V_{CEO}:70V$)
2. High input-output isolation voltage ($V_{ISO}:5,000V_{rms}$)
3. Directly connectable to TTL
4. UL approved (No. E113898(S))

■ APPLICATIONS

1. Telephone sets, telephone exchangers
2. System appliances, measuring instruments
3. Signal transmission between circuits of different potentials and impedances

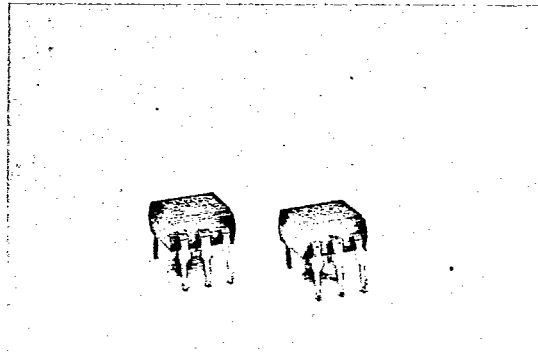

■ OUTLINE DIMENSIONS (UNIT: mm)

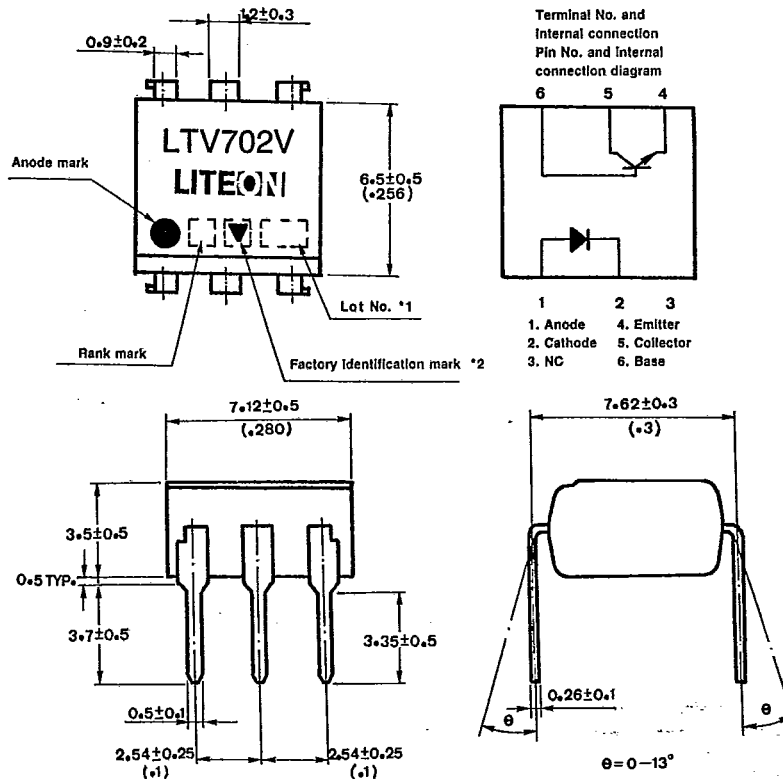

Note *1 2-digit number shall be marked according to DIN standard.
*2 Two version available, one with factory identification mark and the other without.

■ RATINGS AND CHARACTERISTICS

• Absolute maximum ratings

(Ta=25°C)

Parameter		Symbol	Rating	Unit
Input	Forward current	I _F	60	mA
	*1 Peak forward current	I _{FM}	1.5	A
	Reverse Voltage	V _R	6	V
	Power dissipation	P	105	mW
Output	Collector-emitter voltage	V _{CEO}	70	V
	Emitter-collector voltage	V _{ECO}	6	V
	Collector current	I _C	50	mA
	Collector power dissipation	P _C	160	mW
	Collector-base voltage	V _{CBO}	70	V
	Emitter-base voltage	V _{EBO}	6	V
Total power dissipation		P _{tot}	200	mW
Operating temperature		T _{opr}	-55~+100	°C
Storage temperature		T _{stg}	-55~+150	°C
*2 Isolation voltage		V _{iso}	5	kVrms
*3 Soldering temperature		T _{sol}	260	°C

*1 Pulse width ≤ 10μs, Duty ratio: 0.0004

*2 AC for 1 minute, R.H.=40~60%

*3 For 10 seconds.



T-41-83

• Electro-optical characteristics

(Ta=25°C)

Parameter		Symbol	Min.	Typ.	Max.	Unit	Conditions
Input	Forward voltage	V_F	—	1.4	1.7	V	$I_F=60\text{mA}$
	Reverse current	I_R	—	—	10	μA	$V_R=6\text{V}$
	Terminal capacitance	C_t	—	30	250	pF	$V=0, f=1\text{kHz}$
Output	Collector dark current	I_{CEO}	—	—	50	nA	$V_{CE}=10\text{V}, I_F=0$
	Collector-emitter breakdown voltage	BV_{CEO}	70	—	—	V	$I_C=0.1\text{mA}, I_F=0$
	Emitter collector breakdown voltage	BV_{ECO}	6	—	—	V	$I_E=10\mu\text{A}, I_F=0$
	Collector-base breakdown voltage	BV_{CBO}	70	—	—	V	$I_C=0.1\text{mA}, I_F=0$
Transfer characteristics	* Collector current	I_C	4	—	32	mA	$I_F=10\text{mA}, V_{CE}=5\text{V}$
	Collector-emitter saturation voltage	$V_{CE}(\text{sat})$	—	0.25	0.4	V	$I_F=10\text{mA}, I_C=2.5\text{mA}$
	Isolation resistance	R_{ISO}	5×10^{10}	1×10^{11}	—	Ω	DC500V, 40~60%R.H
	Floating capacitance	C_f	—	0.6	1.0	pF	$V=0, f=1\text{MHz}$
	Cut-off frequency	f_c	—	150	—	KHz	$V_{CC}=5\text{V}, I_F=10\text{mA}$ $R_L=75\Omega, -3\text{dB}$
	Response time (Rise)	t_r	—	2	7	μs	$V_{CC}=5\text{V}, I_F=10\text{mA}$ $R_L=75\Omega$
	Response time (Fall)	t_f	—	2	8	μs	

$$*CTR = \frac{I_C}{I_F} \times 100\%$$

A-58

73

■ SUPPLEMENT

• Isolation voltage shall be measured in the following method

- (1) Anode and cathode on input side, collector and emitter on output side shall be shortened individually.
- (2) Isolation voltage tester with a zero-cross circuit shall be used.
- (3) Waveform of applied voltage shall be a sine wave.
(It is recommended that the isolation voltage shall be measured in insulation oil.)

• Collector current I_C is classified as follows.

Model No.	Rank mark	I_C (mA)
LTV 702V A	A	4.0~8.0
LTV 702V B	B	6.3~12.5
LTV 702V C	C	10~20
LTV 702V D	D	16~32
LTV 702V	A or B or C or D	4.0~32

Conditions	$I_F=10\text{mA}$ $V_{CE}=5\text{V}$ $T_a=25^\circ\text{C}$
------------	---

• Inspection standard

Outgoing inspection standard for LITON products are shown below.

- (1) A single sampling plan, normal inspection level II based on MIL-STD-105D is applied. The AQL according to the inspection items are shown below.

Defect	Inspection item	AQL(%)	Judgement criterion
Major defect	<ul style="list-style-type: none"> • Electrical characteristics • Unreadable marking • Open, short 	0.25	Depend on the specification
Minor defect	<ul style="list-style-type: none"> • Appearance • Dimension 	0.4	

Fig. 1 Forward Current vs. Ambient Temperature

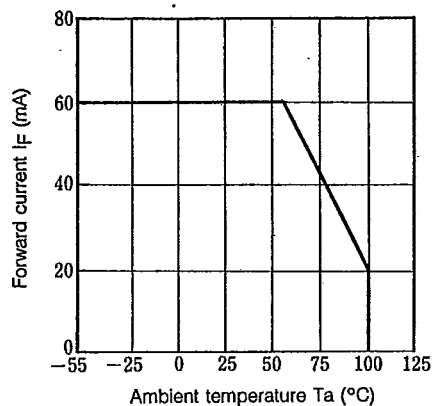

Fig. 2 Collector Power Dissipation vs. Ambient Temperature

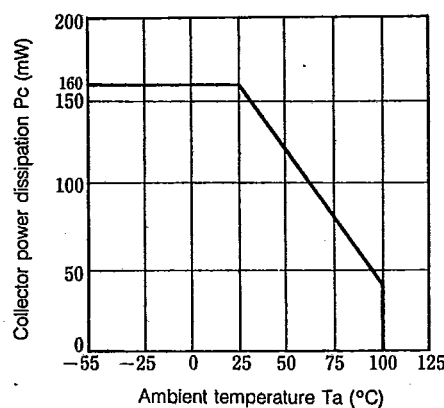



Fig. 3 Peak Forward Current vs. Duty Ratio

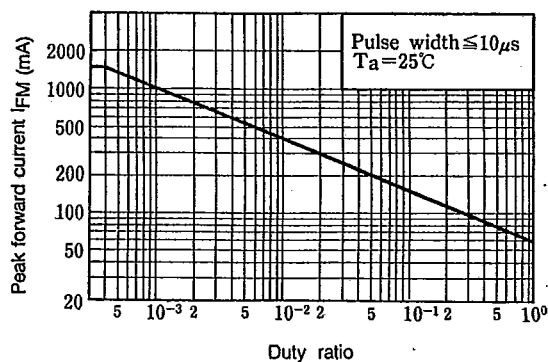

Fig. 4 Forward Current vs. Forward Voltage

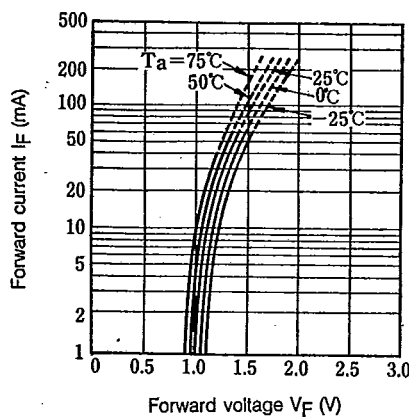

Fig. 5 Current Transfer Ratio vs. Forward Current

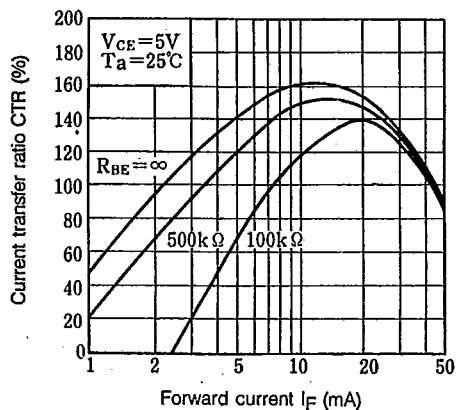

Fig. 6 Collector Current vs. Collector-emitter Voltage

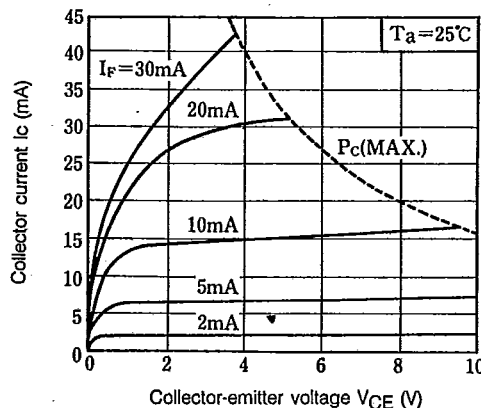

Fig. 7 Relative Current Transfer Ratio vs. Ambient Temperature

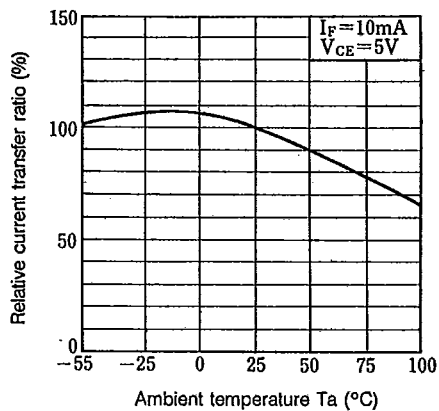

Fig. 8 Collector-emitter Saturation Voltage vs. Ambient Temperature

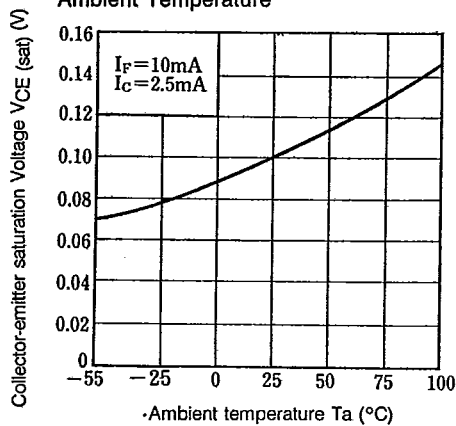

Fig. 9 Collector Dark Current vs. Ambient Temperature

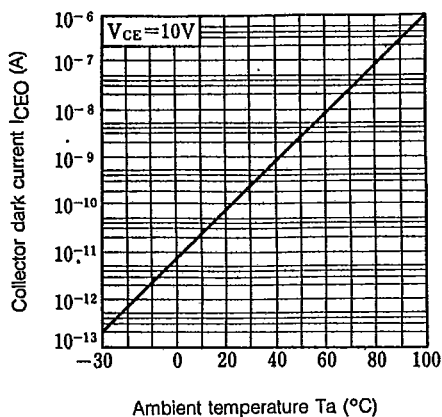

Fig. 10 Collector-emitter Saturation Voltage vs. Forward Current

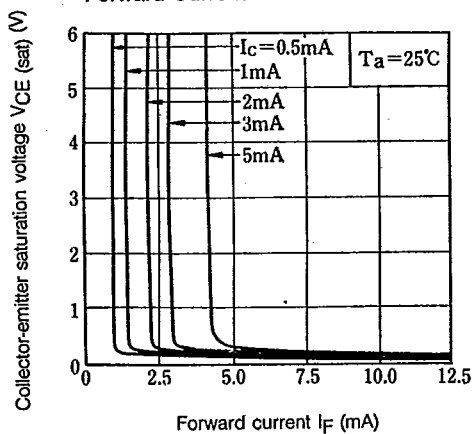

Fig. 11 Response Time vs. Load Resistance

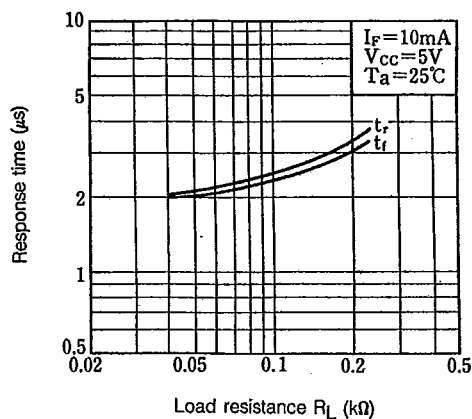
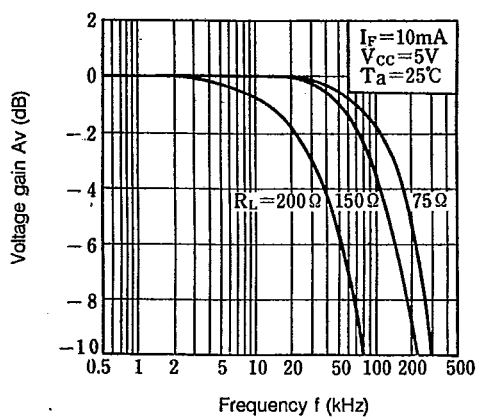
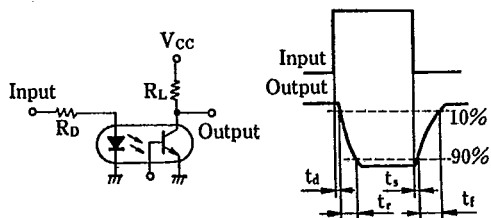

Fig. 12. Frequency Response



Test Circuit for Response Time



Test Circuit for Frequency Response

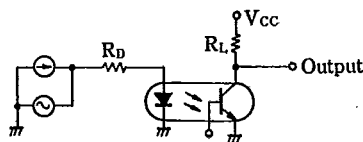

PACKAGING

T-90-20

Reel Packaging (Axial Lead Units)

DEVICE TYPE	COMPONENT SPACE (MM) "A"	TAPE SPACE (MM) "B"	REEL DIA (MM) "D"	QUANTITY (EA)		CARTON	
				REEL	CARTON	SIZE (MM)	WEIGHT (KG)
DO-41 DO-41L	5±0.5	52.4±1.5	326~336	5000	20K	355 x 355 x 355	10.5
DO-201AD	10±0.5	52.4±1.5	326~336	1200	4.8K	355 x 355 x 355	9.0
P6(Aleg)	10±0.5	52.4±1.5	326~336	700	2.8K	355 x 355 x 355	8.8

The C dimension of Fig. 3 is between 3.17m.m. and 635mm greater than the length of the component involved.

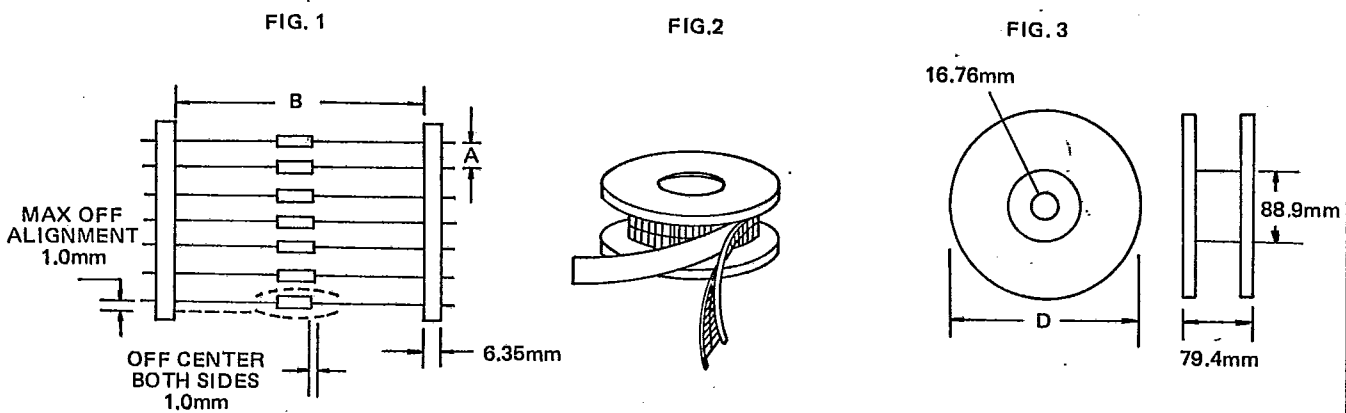

Bulk Packaging (Axial Lead Devices and Bridge Rectifiers)

DEVICE TYPE	PACKAGING SIZE (MM)		QUANTITY (EA)		APPROX GROSS WEIGHT (KG)	
	BOX	CARTON	BOX	CARTON	BOX	CARTON
DO-41 DO-41L	196 x 84 x 20	450 x 210 x 250	1000	50K	0.38	20
DO-201AD	305 x 93 x 59	355 x 355 x 355	1000	20K	1.35	28
P6(Aleg)	305 x 93 x 59	355 x 355 x 355	500	10K	1.2	24.5
PBM	357 x 125 x 60	530 x 360 x 340	1000	20K	1.5	32.3
PBDF	495 x 155 x 145	500 x 325 x 305	5000	20K	5.1	21.5
PBP	357 x 125 x 60	530 x 360 x 340	500	10K	1.5	31.5
PBL	375 x 220 x 155	470 x 385 x 455	1000	5K	5.7	30.5
PBPC-6	357 x 125 x 60	560 x 360 x 340	250	5K	1.1	22
PBPC-8	357 x 125 x 60	560 x 360 x 340	250	5K	1.7	35
KBPC	375 x 220 x 365	470 x 390 x 385	500	1K	15.1	31.5
KBPC-W	375 x 220 x 365	470 x 390 x 385	500	1K	14.5	30.0

AMMO BOX PACKAGING

BOX SIZE

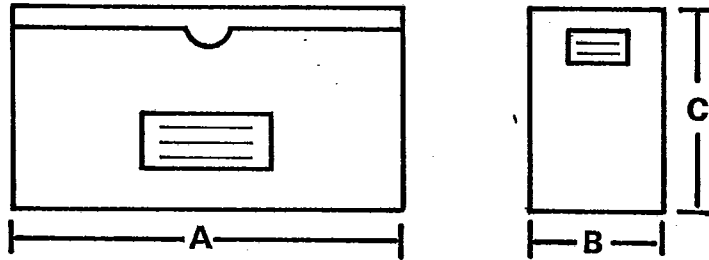

Unit:m. m.

Packaging	Products Outline	Dimension *A*	Dimension *B*	Dimension *C*	Q'ty per BOX
26MM Horizontal Ammo Pack	DO-41 DO-41L(0.6mm Lead)	255	50	95	3K
					3K
52MM Horizontal Ammo Pack	DO-41and DO-41L DO 201AD	250	75	92	3K
					0.8K

CARTON SIZE

Unit:m. m.

Packaging	Products Outline	length	Width	High	Q'ty Per Carton
26MM Horizontal Ammo Pack	DO-41 DO-41L(0.6mm Lead)	330	310	268	42K
					48K
52MM Horizontal Ammo Pack	DO-41and DO-41L DO 201AD	355	355	340	12K

PREFORMED LEAD DRAWING

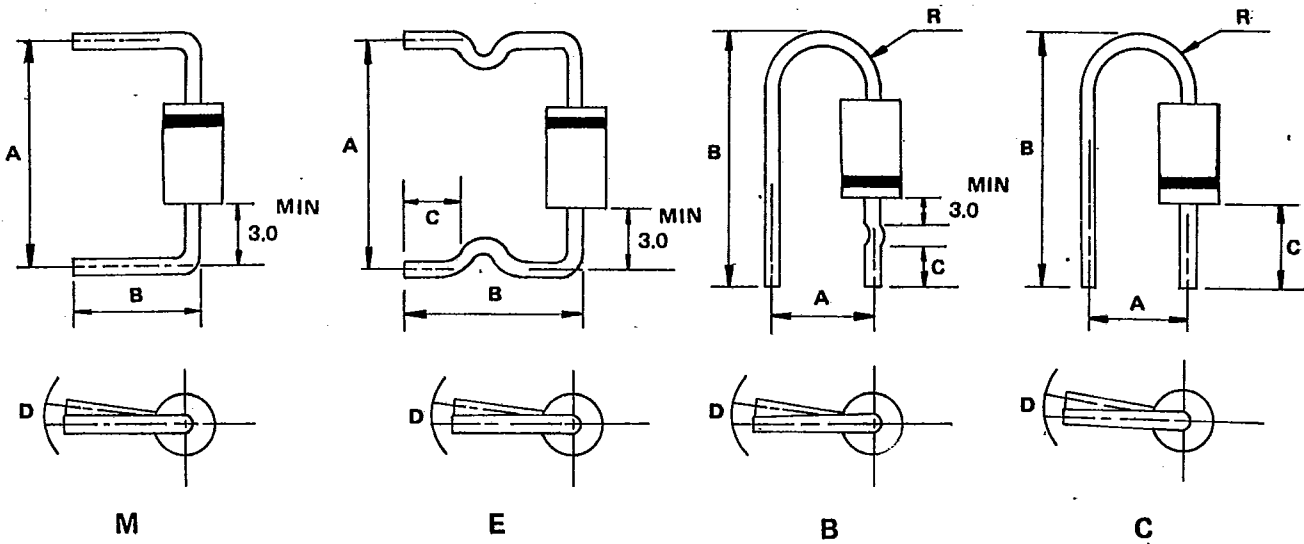

Case type	Preformed type	A (mm)		B (mm)		C (mm)		D (mm)		R (mm)	
		range	tolerance	range	tolerance	range	tolerance	range	tolerance	range	tolerance
D041	M	9.0-20.0	1.0	8.0-22.0	±0.5	-	-	1.5	max	-	-
	E	11.0-20.0	±1.0	11.0-16.0	±1.0	4.0-5.0	±0.5	1.5	max	-	-
	B	7.5	±0.5	19.0-22.0	±0.5	7.5	±0.5	1.5	max	2.5-4.0	Typ
	C	4.5	±0.8	18.0-19.0	±0.5	9.0	±0.5	1.5	max	2.5-4.0	Typ
D0201AD	M	15.0-20.0	±1.0	8.0-22.0	±1.0	-	-	2.0	max	-	-
	E	15.0-20.0	±1.0	10.0-22.0	±1.0	3.0-15.0	±0.5	2.0	max	-	-
P6(Aleg)	M	15.0-20.0	±1.0	8.0-22.0	±1.0	-	-	2.0	max	-	-