



RHCA5039 series is suitable for products that need DC insulation resistance test on Line-FG, SG of a communications / signal line. Impulse current capacity is 2,000A 8/20 μ s.

Features

- Chip surge absorber for protection from indirect lighting surge, adaptable to high density surface mount technology
- Impulse current capacity 2,000A 8/20 μ s
- Small electrostatic capacity(Maximum 0.6pF)
- *Impulse Absorption Characteristics*

Impulse waveform 1.2/50 μ s-10,000V

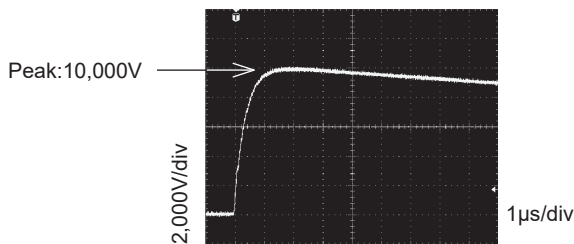

| Safety Standard | | File No. |
|-----------------|-------------------------------|----------|
| UL | :UL1449 4th. | E322107 |
| cUL | :C22.2 No.8-13 | |
| UL-EU | :EN61643-311 :IEC61643-311 | |

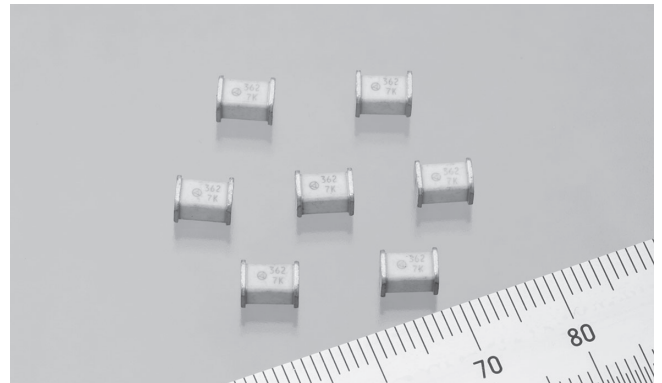

RHCA-242H53U
Impulse waveform

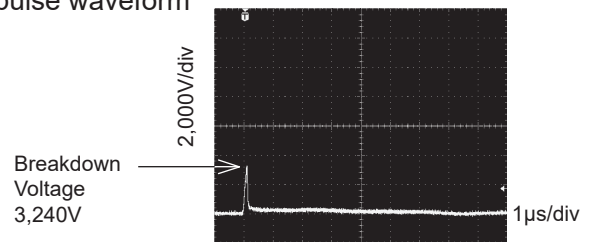

Electrical Specifications

•RHCA53 series

| Safety Standard | | Model Number | Impulse Sparkover Voltage 1.2/50 μ s (V) max. | | Withstanding Voltage 50/60Hz | Insulation Resistance (M Ω) Min. | Capacitance 1MHz (pF) Max. | Impulse Life Test | Impulse Current Capacity | DC Breakdown Voltage (V) |
|-----------------------------|-------|--------------|--|---------------|---------------------------------|---|----------------------------------|-----------------------------------|--------------------------|-----------------------------|
| UL1449 cUL | UL-EU | | Applied Voltage | Specification | | | | | | |
| ○ ¹ | ○ | RHCA-242H53U | 5,000V | 4,500V max. | AC1,000V-60sec AC1,200V-3sec | 1,000(DC500V) | 0.6 | 8/20 μ s 100A 300 times | 8/20 μ s 2,000A | 2,400 \pm 20% *3 |
| ○ ₂ ¹ | ○ | RHCA-302H53U | | 4,700V max. | AC1,500V-60sec | | | | | 3,000 \pm 20% *3 |
| ○ ₂ ¹ | ○ | RHCA-362H53U | | 4,950V max. | AC1,500V-60sec AC1,800V-3sec | | | | | 3,600 \pm 20% *3 |

•RHCA53(335) series

| Safety Standard | | Model Number | Impulse Sparkover Voltage 1.2/50 μ s (V) max. | | Withstanding Voltage 50/60Hz | Insulation Resistance (M Ω) Min. | Capacitance 1MHz (pF) Max. | Impulse Life Test | Impulse Current Capacity | DC Breakdown Voltage (V) | | | |
|-----------------------------|-------|-------------------|--|---------------|---|---|----------------------------------|-----------------------------------|--------------------------|-----------------------------|-------------|--------------|--------------------|
| UL1449 cUL | UL-EU | | Applied Voltage | Specification | | | | | | | | | |
| ○ ₂ ¹ | ○ | RHCA-102P53U(335) | 5,000V | 4,500V max. | AC1,000V 60s AC1,000V 60s AC1,200V 3s AC1,200V 60s | 1,000(DC500V) | 0.6 | 8/20 μ s 100A 300 times | 8/20 μ s 3,500A | 1,000 \pm 20% | | | |
| ○ ₂ ¹ | ○ | RHCA-102Q53U(335) | | | | | | | | - | - | - | 1,000 \pm 30% |
| ○ ¹ | ○ | RHCA-202H53U(335) | | | | | | | | 2,000 \pm 20% *3 | | | |
| ○ ¹ | ○ | RHCA-242H53U(335) | | | | | | | | 2,400 \pm 20% *3 | | | |
| ○ ¹ | ○ | RHCA-272H53U(335) | | | | | | | | 2,700 \pm 20% *3 | | | |
| ○ ₂ ¹ | ○ | RHCA-302H53U(335) | | | | | | | | 3,000 \pm 20% *3 | | | |
| ○ ₂ ¹ | ○ | RHCA-362H53U(335) | | | | | | | | 3,600 \pm 20% *3 | | | |
| ○ ₂ ¹ | ○ | RHCA-402H53U(335) | | | | | | | | 7,500V | 7,450V max. | AC2,000V 60s | 4,000 \pm 20% *3 |
| ○ ₂ ¹ | ○ | RHCA-452H53U(335) | | | | | | | | 8,000V | 7,950V max. | AC2,000V 60s | 4,500 \pm 20% *3 |

*1 Rated voltage AC125V: Approved if it is connected to UL approved varistor (V1.0mA \geq 270V, D \geq 7 mm).

*2 Rated voltage AC250V: Approved if it is connected to UL approved varistor (V1.0mA \geq 470V, D \geq 7 mm). *3 Reference Value
Operating Temperature: -40~+85°C



• Dimensions

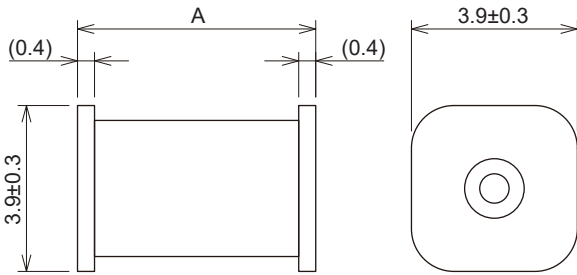

| Model Number | A |
|---------------|---------|
| RHCA5039 | 5.0±0.3 |
| RHCA5039(335) | 5.6±0.3 |

Unit: mm

• Description of marking

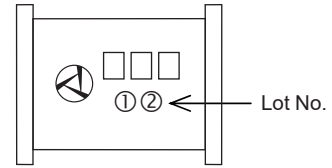

□□□..... DC Breakdown Voltage
eg.) RHCA-362H53U→362

[Lot No.] ①..... Identification of manufacture year
eg.) 2020→0

②..... Manufacture month (see below)

| Month | 1 | 2 | 3 | 4 | 5 | 6 | 7 | 8 | 9 | 10 | 11 | 12 |
|--------|---|---|---|---|---|---|---|---|---|----|----|----|
| Symbol | A | B | D | E | F | G | H | J | K | L | M | N |

• Taping Dimensions

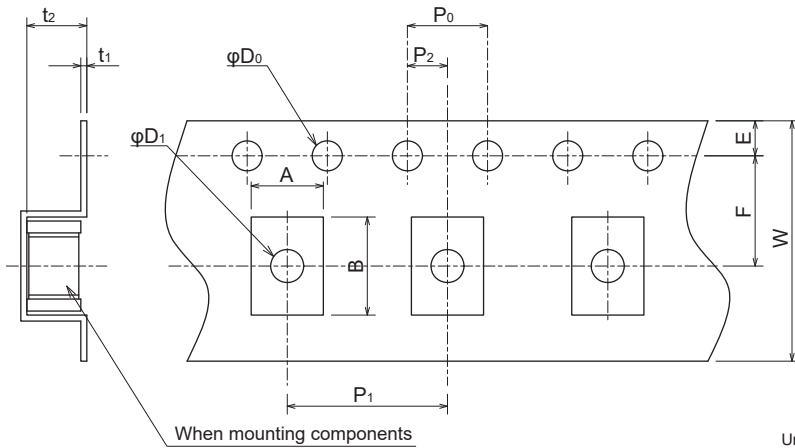

| Dimensions (mm) | | |
|-----------------|------------|---------------|
| | RHCA5039 | RHCA5039(335) |
| A | 4.5±0.3 | 4.2±0.3 |
| B | 5.6±0.3 | 6.0±0.3 |
| W | 12.0±0.3 | 12.0±0.3 |
| F | 5.5±0.1 | 5.5±0.1 |
| E | 1.75±0.1 | 1.75±0.2 |
| P1 | 8.0±0.1 | 8.0±0.2 |
| P2 | 2.0±0.1 | 2.0±0.1 |
| P0 | 4.0±0.1 | 4.0±0.2 |
| D0 | φ 1.55±0.1 | φ 1.55±0.1 |
| D1 | φ 1.5 min. | φ 1.7+0.2 |
| t1 | 0.4±0.2 | 0.4±0.1 |
| t2 | 4.3±0.2 | 4.2±0.2 |

Unit: mm

• Reel Dimensions (2,500pcs per one reel)

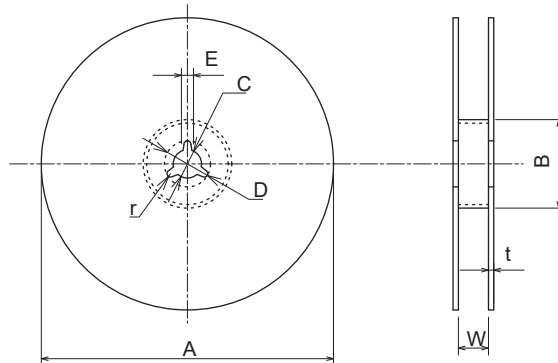

| Dimensions (mm) | |
|-----------------|------------|
| A | φ 380±3 |
| B | φ 80±2 |
| C | φ 13.0±0.5 |
| D | φ 21±1 |
| E | 2±1 |
| W | 13.5±2.0 |
| t | 2.0±0.5 |
| r | 1.0±0.2 |

Unit: mm

• Recommended Land Pattern (Typical value)

RHCA5039 Series

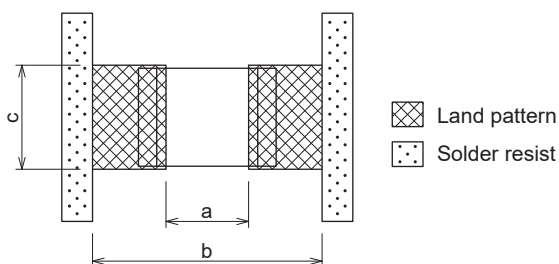

| | Dimensions (mm) | | |
|------------------|-----------------|-----|-----|
| | a | b | c |
| Reflow Soldering | 3.7 | 6.5 | 4.3 |

RHCA5039(335) Series

