

JFET VHF/UHF Amplifiers

N-Channel — Depletion

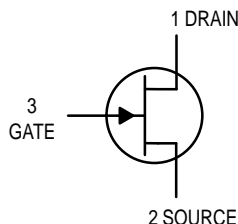

2N5484
2N5486

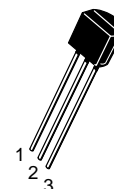

CASE 29-04, STYLE 5
TO-92 (TO-226AA)

MAXIMUM RATINGS

Rating	Symbol	Value	Unit
Drain–Gate Voltage	V_{DG}	25	Vdc
Reverse Gate–Source Voltage	V_{GSR}	25	Vdc
Drain Current	I_D	30	mAdc
Forward Gate Current	$I_{G(f)}$	10	mAdc
Total Device Dissipation @ $T_C = 25^\circ\text{C}$ Derate above 25°C	P_D	350 2.8	mW mW/ $^\circ\text{C}$
Operating and Storage Junction Temperature Range	T_J, T_{stg}	-65 to +150	$^\circ\text{C}$

ELECTRICAL CHARACTERISTICS ($T_A = 25^\circ\text{C}$ unless otherwise noted)

Characteristic	Symbol	Min	Typ	Max	Unit
----------------	--------	-----	-----	-----	------

OFF CHARACTERISTICS

Gate–Source Breakdown Voltage ($I_G = -1.0 \mu\text{Adc}$, $V_{DS} = 0$)	$V_{(BR)GSS}$	-25	—	—	Vdc	
Gate Reverse Current ($V_{GS} = -20 \text{ Vdc}$, $V_{DS} = 0$) ($V_{GS} = -20 \text{ Vdc}$, $V_{DS} = 0$, $T_A = 100^\circ\text{C}$)	I_{GSS}	— —	— —	-1.0 -0.2	nAdc μAdc	
Gate Source Cutoff Voltage ($V_{DS} = 15 \text{ Vdc}$, $I_D = 10 \text{ nAdc}$)	$V_{GS(off)}$	2N5484 2N5486	-0.3 -2.0	— —	-3.0 -6.0	Vdc

ON CHARACTERISTICS

Zero–Gate–Voltage Drain Current ($V_{DS} = 15 \text{ Vdc}$, $V_{GS} = 0$)	I_{DSS}	2N5484 2N5486	1.0 8.0	— —	5.0 20	mAdc
---	-----------	------------------	------------	--------	-----------	------

SMALL–SIGNAL CHARACTERISTICS

Forward Transfer Admittance ($V_{DS} = 15 \text{ Vdc}$, $V_{GS} = 0$, $f = 1.0 \text{ kHz}$)	$ y_{fs} $	2N5484 2N5486	3000 4000	— —	6000 8000	μhos
Input Admittance ($V_{DS} = 15 \text{ Vdc}$, $V_{GS} = 0$, $f = 100 \text{ MHz}$) ($V_{DS} = 15 \text{ Vdc}$, $V_{GS} = 0$, $f = 400 \text{ MHz}$)	$\text{Re}(y_{is})$	2N5484 2N5486	— —	— —	100 1000	μhos
Output Admittance ($V_{DS} = 15 \text{ Vdc}$, $V_{GS} = 0$, $f = 1.0 \text{ kHz}$)	$ y_{os} $	2N5484 2N5486	— —	— —	50 75	μhos
Output Conductance ($V_{DS} = 15 \text{ Vdc}$, $V_{GS} = 0$, $f = 100 \text{ MHz}$) ($V_{DS} = 15 \text{ Vdc}$, $V_{GS} = 0$, $f = 400 \text{ MHz}$)	$\text{Re}(y_{os})$	2N5484 2N5486	— —	— —	75 100	μhos
Forward Transconductance ($V_{DS} = 15 \text{ Vdc}$, $V_{GS} = 0$, $f = 100 \text{ MHz}$) ($V_{DS} = 15 \text{ Vdc}$, $V_{GS} = 0$, $f = 400 \text{ MHz}$)	$\text{Re}(y_{fs})$	2N5484 2N5486	2500 3500	— —	— —	μhos

ELECTRICAL CHARACTERISTICS ($T_A = 25^\circ\text{C}$ unless otherwise noted) (Continued)

Characteristic	Symbol	Min	Typ	Max	Unit
SMALL-SIGNAL CHARACTERISTICS (continued)					
Input Capacitance ($V_{DS} = 15\text{ Vdc}$, $V_{GS} = 0$, $f = 1.0\text{ MHz}$)	C_{iss}	—	—	5.0	pF
Reverse Transfer Capacitance ($V_{DS} = 15\text{ Vdc}$, $V_{GS} = 0$, $f = 1.0\text{ MHz}$)	C_{rss}	—	—	1.0	pF
Output Capacitance ($V_{DS} = 15\text{ Vdc}$, $V_{GS} = 0$, $f = 1.0\text{ MHz}$)	C_{oss}	—	—	2.0	pF

FUNCTIONAL CHARACTERISTICS

Noise Figure ($V_{DS} = 15\text{ Vdc}$, $V_{GS} = 0$, $R_G = 1.0\text{ Megohm}$, $f = 1.0\text{ kHz}$) ($V_{DS} = 15\text{ Vdc}$, $I_D = 1.0\text{ mAdc}$, $R_G \approx 1.0\text{ k}\Omega$, $f = 100\text{ MHz}$) ($V_{DS} = 15\text{ Vdc}$, $I_D = 1.0\text{ mAdc}$, $R_G \approx 1.0\text{ k}\Omega$, $f = 200\text{ MHz}$) ($V_{DS} = 15\text{ Vdc}$, $I_D = 4.0\text{ mAdc}$, $R_G \approx 1.0\text{ k}\Omega$, $f = 100\text{ MHz}$) ($V_{DS} = 15\text{ Vdc}$, $I_D = 4.0\text{ mAdc}$, $R_G \approx 1.0\text{ k}\Omega$, $f = 400\text{ MHz}$)	 2N5484 2N5484 2N5486 2N5486	NF	—	—	2.5	dB
Common Source Power Gain ($V_{DS} = 15\text{ Vdc}$, $I_D = 1.0\text{ mAdc}$, $f = 100\text{ MHz}$) ($V_{DS} = 15\text{ Vdc}$, $I_D = 1.0\text{ mAdc}$, $f = 200\text{ MHz}$) ($V_{DS} = 15\text{ Vdc}$, $I_D = 4.0\text{ mAdc}$, $f = 100\text{ MHz}$) ($V_{DS} = 15\text{ Vdc}$, $I_D = 4.0\text{ mAdc}$, $f = 400\text{ MHz}$)	 2N5484 2N5484 2N5486 2N5486	G_{ps}	16	—	25	
			—	14	—	
			18	—	30	
			10	—	20	

POWER GAIN

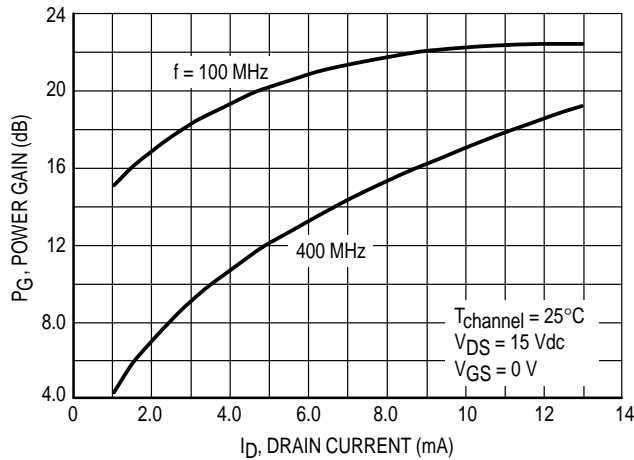
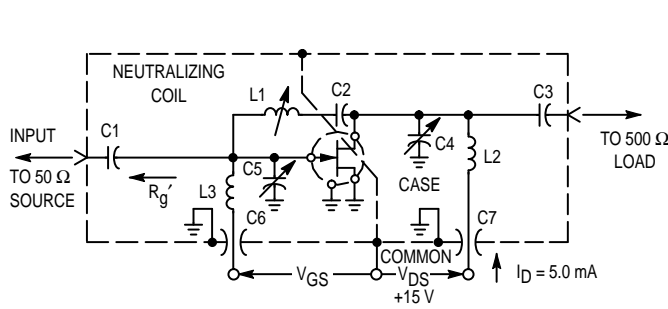

Figure 1. Effects of Drain Current



Adjust V_{GS} for
 $I_D = 5.0 \text{ mA}$
 $V_{GS} < 0 \text{ Volts}$

NOTE: The noise source is a hot-cold body (AIL type 70 or equivalent) with a test receiver (AIL type 136 or equivalent).

Reference Designation	VALUE	
	100 MHz	400 MHz
C1	7.0 pF	1.8 pF
C2	1000 pF	17 pF
C3	3.0 pF	1.0 pF
C4	1-12 pF	0.8-8.0 pF
C5	1-12 pF	0.8-8.0 pF
C6	0.0015 μF	0.001 μF
C7	0.0015 μF	0.001 μF
L1	3.0 μH^*	0.2 μH^{**}
L2	0.15 μH^*	0.03 μH^{**}
L3	0.14 μH^*	0.022 μH^{**}

- *L1 17 turns, (approx. — depends upon circuit layout) AWG #28 enameled copper wire, close wound on 9/32" ceramic coil form. Tuning provided by a powdered iron slug.
- L2 4-1/2 turns, AWG #18 enameled copper wire, 5/16" long, 3/8" I.D. (AIR CORE).
- L3 3-1/2 turns, AWG #18 enameled copper wire, 1/4" long, 3/8" I.D. (AIR CORE).

- **L1 6 turns, (approx. — depends upon circuit layout) AWG #24 enameled copper wire, close wound on 7/32" ceramic coil form. Tuning provided by an aluminum slug.
- L2 1 turn, AWG #16 enameled copper wire, 3/8" I.D. (AIR CORE).
- L3 1/2 turn, AWG #16 enameled copper wire, 1/4" I.D. (AIR CORE).

Figure 2. 100 MHz and 400 MHz Neutralized Test Circuit

NOISE FIGURE
 $(T_{\text{channel}} = 25^\circ\text{C})$

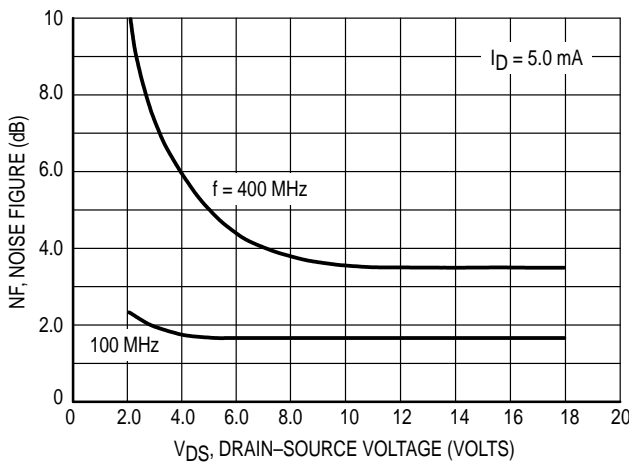

Figure 3. Effects of Drain-Source Voltage

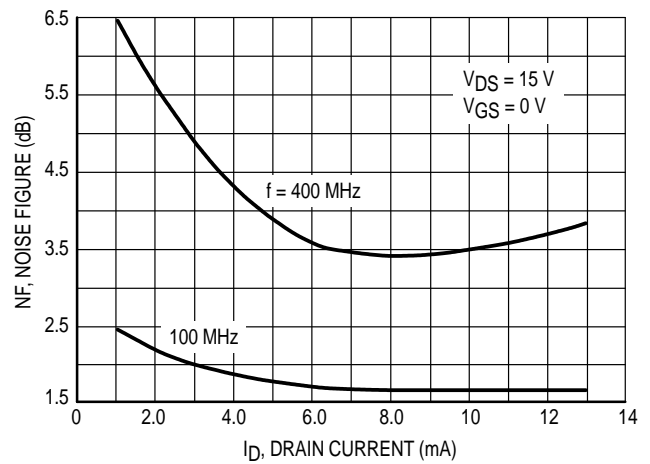

Figure 4. Effects of Drain Current

INTERMODULATION CHARACTERISTICS

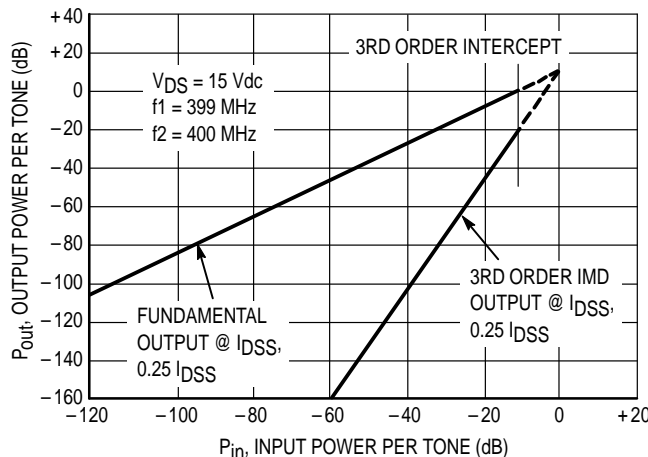

Figure 5. Third Order Intermodulation Distortion

COMMON SOURCE CHARACTERISTICS
ADMITTANCE PARAMETERS
 (V_{DS} = 15 Vdc, T_{channel} = 25°C)

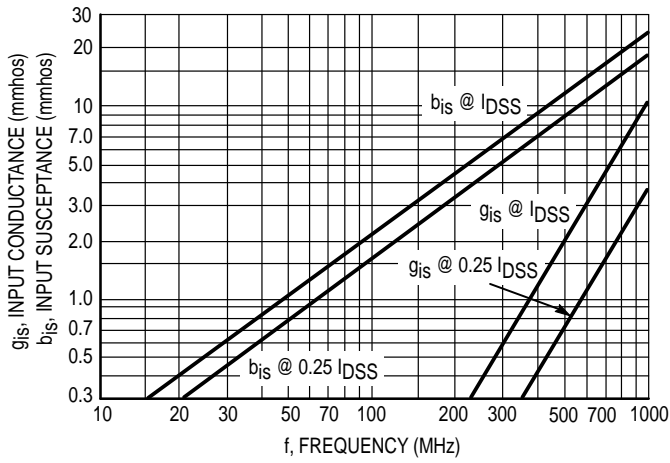

Figure 6. Input Admittance (y_{is})

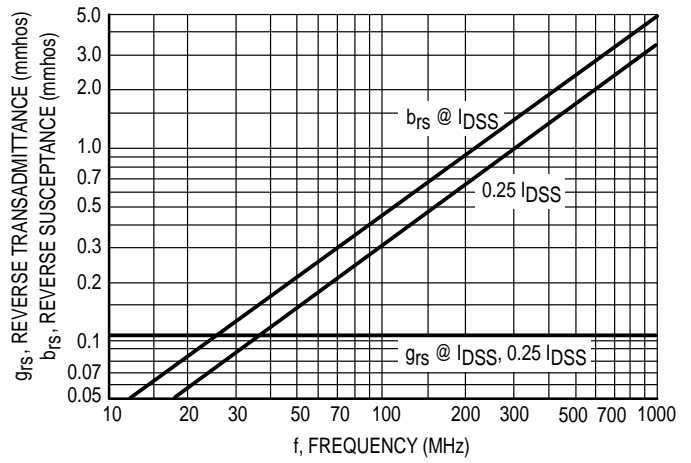

Figure 7. Reverse Transfer Admittance (y_{rs})

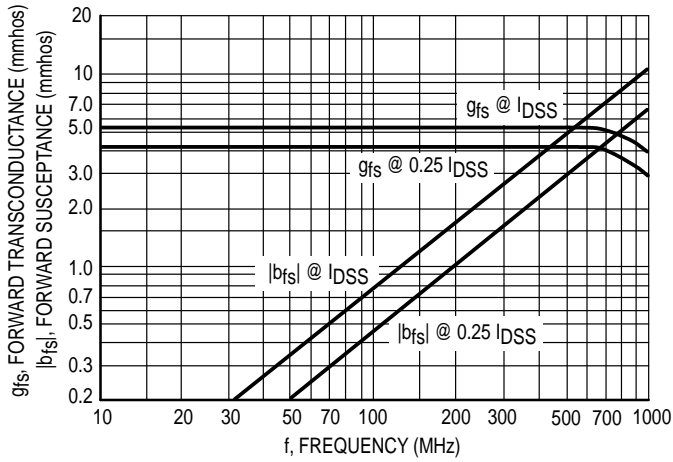

Figure 8. Forward Transadmittance (y_{fs})

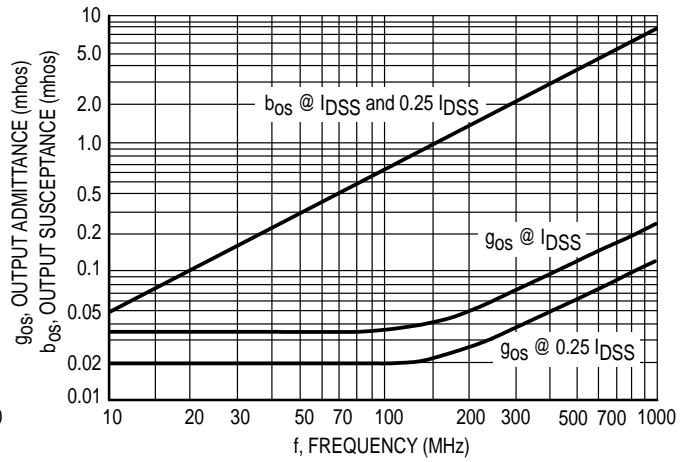

Figure 9. Output Admittance (y_{os})

COMMON SOURCE CHARACTERISTICS
S-PARAMETERS
 ($V_{DS} = 15 \text{ Vdc}$, $T_{\text{channel}} = 25^\circ\text{C}$, Data Points in MHz)

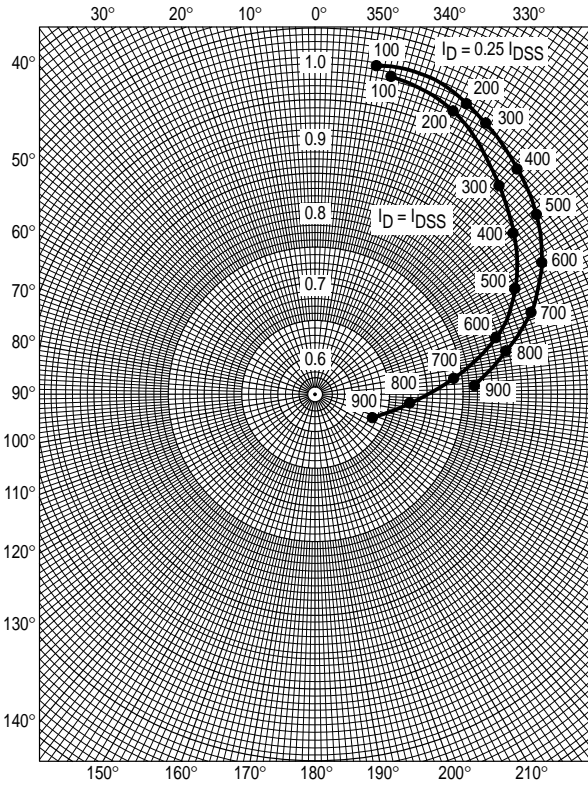

Figure 10. S_{11s}

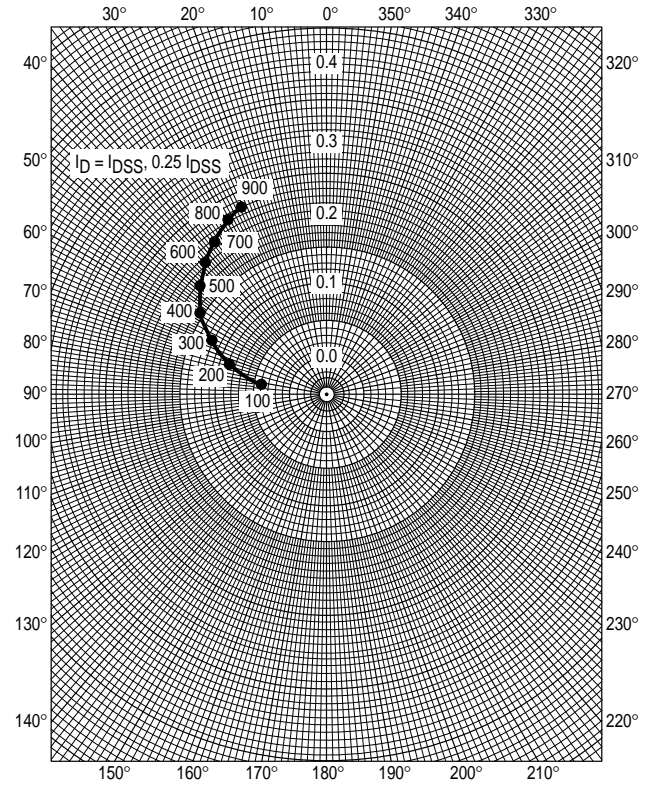

Figure 11. S_{12s}

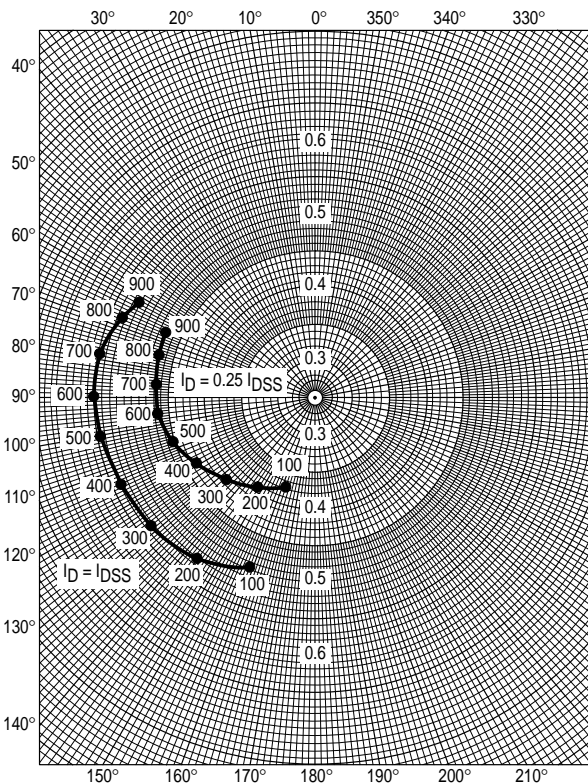

Figure 12. S_{21s}

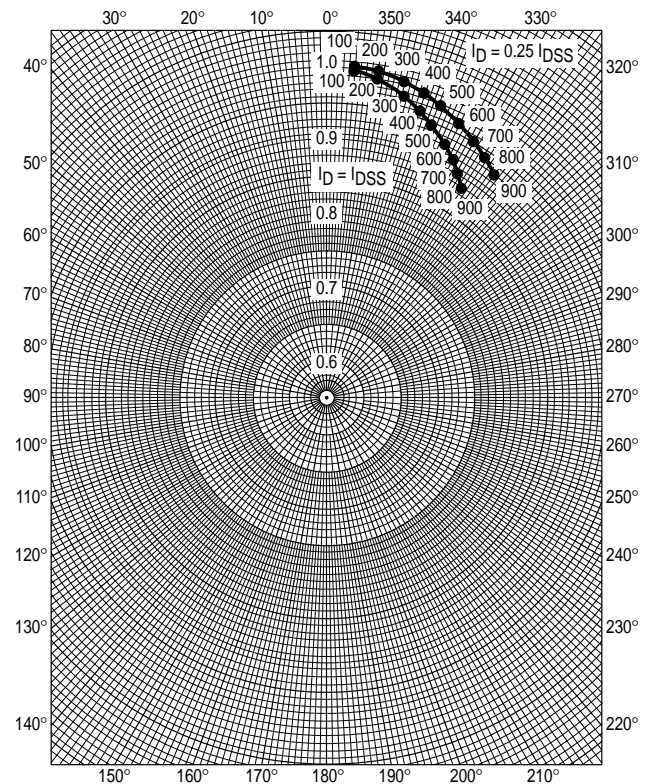

Figure 13. S_{22s}

COMMON GATE CHARACTERISTICS

ADMITTANCE PARAMETERS

(V_{DG} = 15 Vdc, T_{channel} = 25°C)

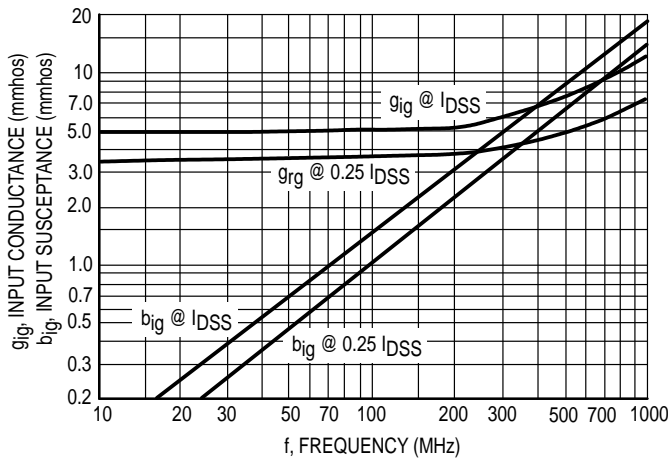

Figure 14. Input Admittance (y_{ig})

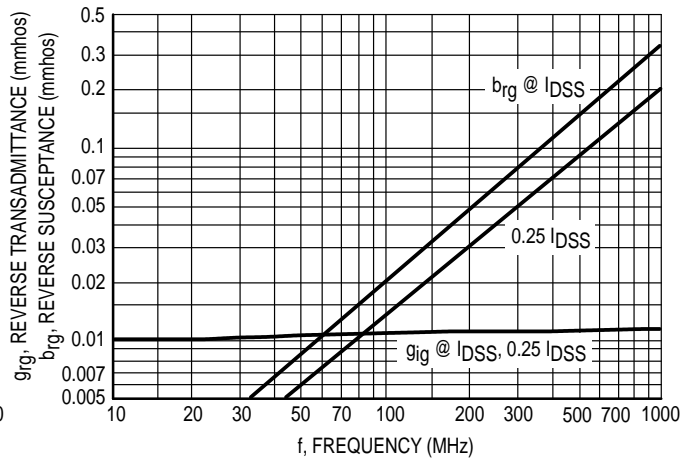

Figure 15. Reverse Transfer Admittance (y_{rg})

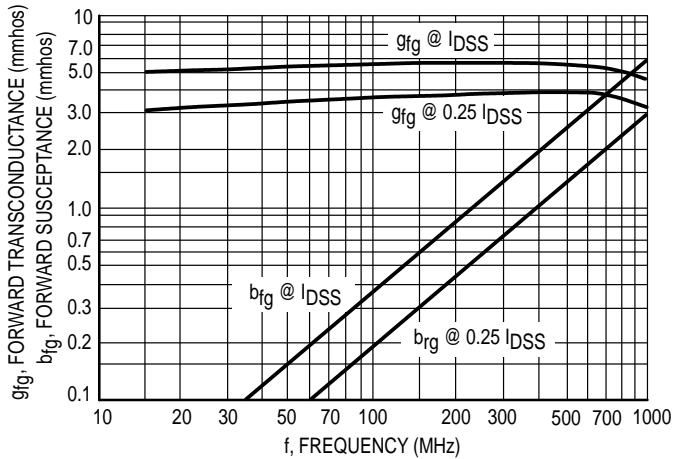

Figure 16. Forward Transfer Admittance (y_{fg})

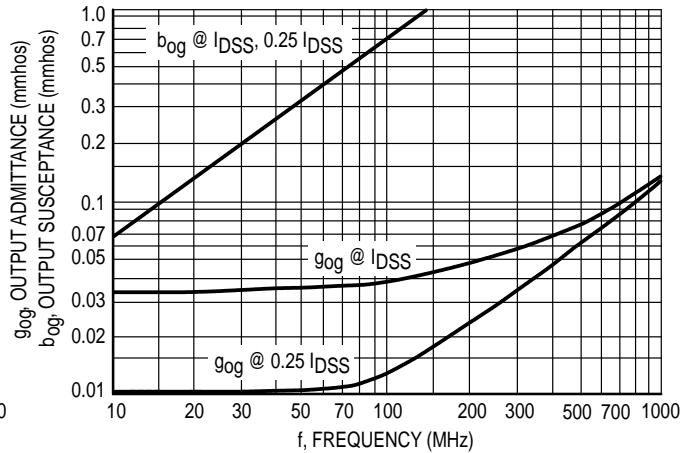

Figure 17. Output Admittance (y_{og})

COMMON GATE CHARACTERISTICS
S-PARAMETERS

($V_{DS} = 15 \text{ Vdc}$, $T_{\text{channel}} = 25^\circ\text{C}$, Data Points in MHz)

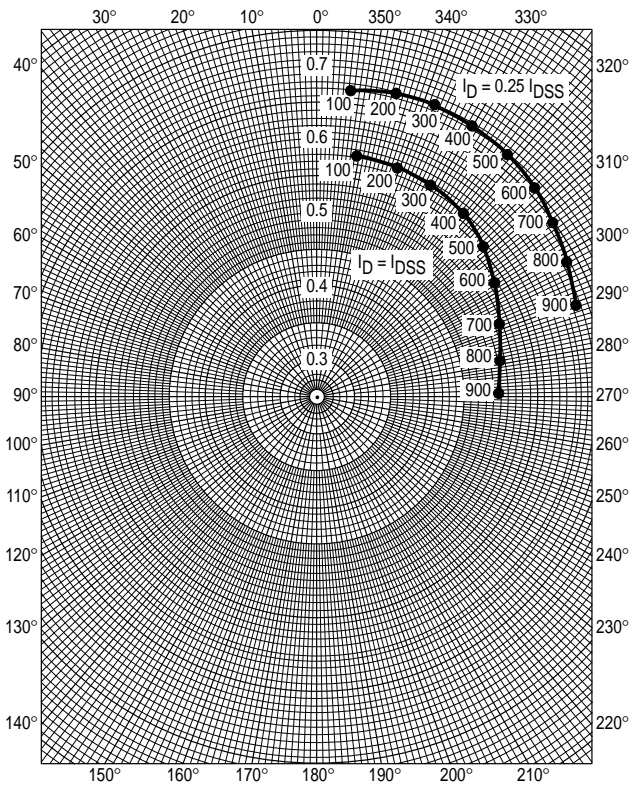

Figure 18. S_{11g}

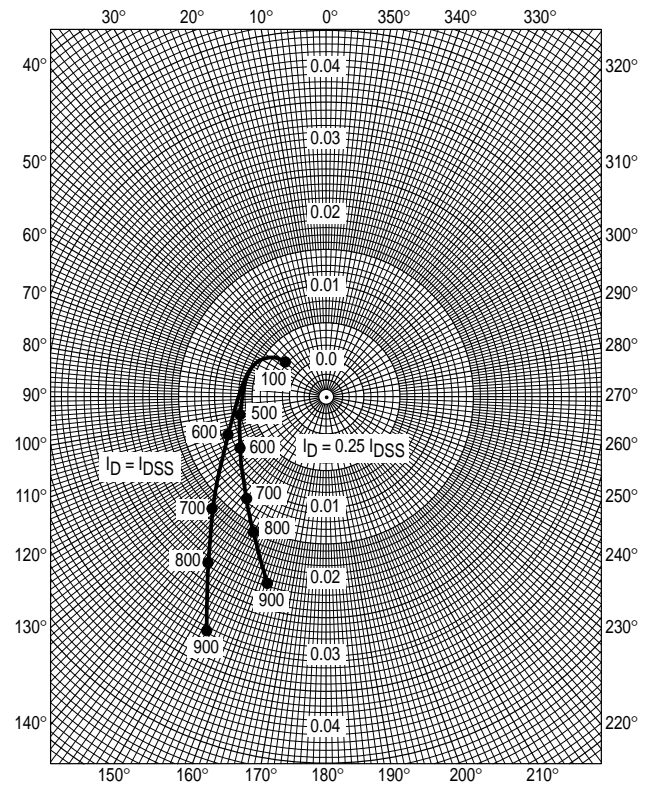

Figure 19. S_{12g}

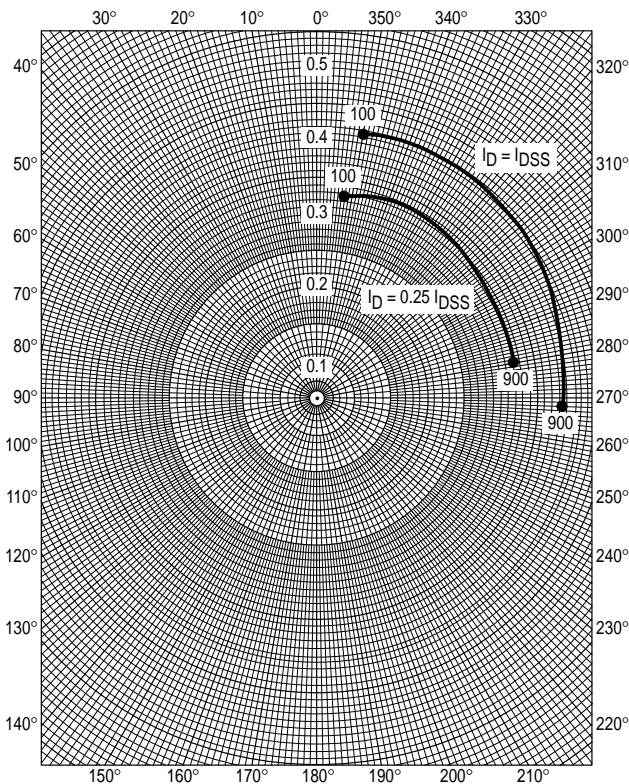

Figure 20. S_{21g}

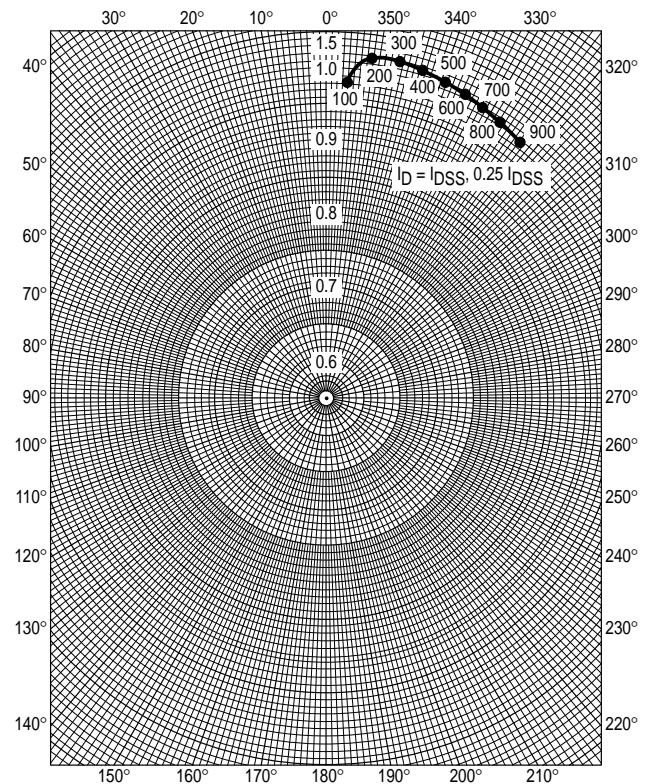
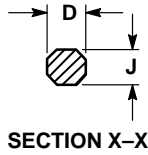
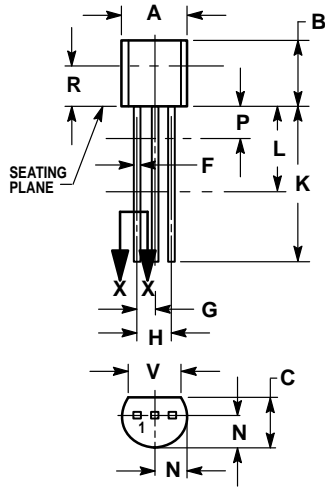

Figure 21. S_{22g}

PACKAGE DIMENSIONS



NOTES:

1. DIMENSIONING AND TOLERANCING PER ANSI Y14.5M, 1982.
2. CONTROLLING DIMENSION: INCH.
3. CONTOUR OF PACKAGE BEYOND DIMENSION R IS UNCONTROLLED.
4. DIMENSION F APPLIES BETWEEN P AND L. DIMENSION D AND J APPLY BETWEEN L AND K. MINIMUM. LEAD DIMENSION IS UNCONTROLLED IN P AND BEYOND DIMENSION K MINIMUM.

DIM	INCHES		MILLIMETERS	
	MIN	MAX	MIN	MAX
A	0.175	0.205	4.45	5.20
B	0.170	0.210	4.32	5.33
C	0.125	0.165	3.18	4.19
D	0.016	0.022	0.41	0.55
F	0.016	0.019	0.41	0.48
G	0.045	0.055	1.15	1.39
H	0.095	0.105	2.42	2.66
J	0.015	0.020	0.39	0.50
K	0.500	—	12.70	—
L	0.250	—	6.35	—
N	0.080	0.105	2.04	2.66
P	—	0.100	—	2.54
R	0.115	—	2.93	—
V	0.135	—	3.43	—

CASE 029-04
(TO-226AA)
ISSUE AD

STYLE 5:

- PIN 1. DRAIN
2. SOURCE
3. GATE

Motorola reserves the right to make changes without further notice to any products herein. Motorola makes no warranty, representation or guarantee regarding the suitability of its products for any particular purpose, nor does Motorola assume any liability arising out of the application or use of any product or circuit, and specifically disclaims any and all liability, including without limitation consequential or incidental damages. "Typical" parameters which may be provided in Motorola data sheets and/or specifications can and do vary in different applications and actual performance may vary over time. All operating parameters, including "Typicals" must be validated for each customer application by customer's technical experts. Motorola does not convey any license under its patent rights nor the rights of others. Motorola products are not designed, intended, or authorized for use as components in systems intended for surgical implant into the body, or other applications intended to support or sustain life, or for any other application in which the failure of the Motorola product could create a situation where personal injury or death may occur. Should Buyer purchase or use Motorola products for any such unintended or unauthorized application, Buyer shall indemnify and hold Motorola and its officers, employees, subsidiaries, affiliates, and distributors harmless against all claims, costs, damages, and expenses, and reasonable attorney fees arising out of, directly or indirectly, any claim of personal injury or death associated with such unintended or unauthorized use, even if such claim alleges that Motorola was negligent regarding the design or manufacture of the part. Motorola and are registered trademarks of Motorola, Inc. Motorola, Inc. is an Equal Opportunity/Affirmative Action Employer.

Mfax is a trademark of Motorola, Inc.

How to reach us:

USA/EUROPE/Locations Not Listed: Motorola Literature Distribution;
P.O. Box 5405, Denver, Colorado 80217. 303-675-2140 or 1-800-441-2447

JAPAN: Nippon Motorola Ltd.; Tatsumi-SPD-JLDC, 6F Seibu-Butsuryu-Center,
3-14-2 Tatsumi Koto-Ku, Tokyo 135, Japan. 81-3-3521-8315

Mfax™: RMFAX0@email.sps.mot.com – TOUCHTONE 602-244-6609
– US & Canada ONLY 1-800-774-1848

ASIA/PACIFIC: Motorola Semiconductors H.K. Ltd.; 8B Tai Ping Industrial Park,
51 Ting Kok Road, Tai Po, N.T., Hong Kong. 852-26629298

INTERNET: <http://motorola.com/sps>

