

# PNP Silicon Epitaxial Transistor

This PNP Silicon Epitaxial Transistor is designed for use in low voltage, high current applications. The device is housed in the SOT-223 package, which is designed for medium power surface mount applications.

- High Current:  $I_C = -1.0$  Amp
- The SOT-223 Package can be soldered using wave or reflow.
- SOT-223 package ensures level mounting, resulting in improved thermal conduction, and allows visual inspection of soldered joints. The formed leads absorb thermal stress during soldering, eliminating the possibility of damage to the die.
- Available in 12 mm Tape and Reel
  - Use BCP69T1 to order the 7 inch/1000 unit reel.
  - Use BCP69T3 to order the 13 inch/4000 unit reel.
- NPN Complement is BCP68

## BCP69T1

ON Semiconductor Preferred Device

**MEDIUM POWER  
PNP SILICON  
HIGH CURRENT  
TRANSISTOR  
SURFACE MOUNT**

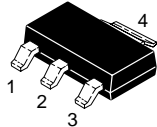

**CASE 318E-04, STYLE 1  
TO-261AA**

### MAXIMUM RATINGS ( $T_C = 25^\circ\text{C}$ unless otherwise noted)

Rating	Symbol	Value	Unit
Collector-Emitter Voltage	$V_{CEO}$	-25	Vdc
Collector-Base Voltage	$V_{CBO}$	-20	Vdc
Emitter-Base Voltage	$V_{EBO}$	-5.0	Vdc
Collector Current	$I_C$	-1.0	Adc
Total Power Dissipation @ $T_A = 25^\circ\text{C}$ <sup>(1)</sup> Derate above $25^\circ\text{C}$	$P_D$	1.5 12	Watts mW/ $^\circ\text{C}$
Operating and Storage Temperature Range	$T_J, T_{stg}$	-65 to 150	$^\circ\text{C}$

1. Device mounted on a glass epoxy printed circuit board 1.575 in. x 1.575 in. x 0.059 in.; mounting pad for the collector lead min. 0.93 sq. in.

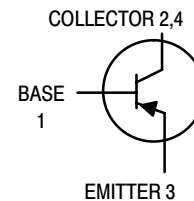

**Preferred** devices are recommended choices for future use and best overall value.

### DEVICE MARKING

CE
----

### THERMAL CHARACTERISTICS

Characteristic	Symbol	Max	Unit
Thermal Resistance — Junction-to-Ambient (surface mounted)	$R_{\theta JA}$	83.3	$^\circ\text{C}/\text{W}$
Lead Temperature for Soldering, 0.0625" from case Time in Solder Bath	$T_L$	260 10	$^\circ\text{C}$ Sec

### ELECTRICAL CHARACTERISTICS ( $T_A = 25^\circ\text{C}$ unless otherwise noted)

Characteristics	Symbol	Min	Typ	Max	Unit
-----------------	--------	-----	-----	-----	------

### OFF CHARACTERISTICS

Collector-Emitter Breakdown Voltage ( $I_C = -100 \mu\text{Adc}, I_E = 0$ )	$V_{(BR)CES}$	-25	—	—	Vdc
Collector-Emitter Breakdown Voltage ( $I_C = -1.0 \text{ mAdc}, I_B = 0$ )	$V_{(BR)CEO}$	-20	—	—	Vdc
Emitter-Base Breakdown Voltage ( $I_E = -10 \mu\text{Adc}, I_C = 0$ )	$V_{(BR)EBO}$	-5.0	—	—	Vdc

# BCP69T1

## ELECTRICAL CHARACTERISTICS ( $T_A = 25^\circ\text{C}$ unless otherwise noted)

Characteristics	Symbol	Min	Typ	Max	Unit
<b>OFF CHARACTERISTICS</b>					
Collector-Base Cutoff Current ( $V_{CB} = -25\text{ Vdc}$ , $I_E = 0$ )	$I_{CBO}$	—	—	-10	$\mu\text{A dc}$
Emitter-Base Cutoff Current ( $V_{EB} = -5.0\text{ Vdc}$ , $I_C = 0$ )	$I_{EBO}$	—	—	-10	$\mu\text{A dc}$
<b>ON CHARACTERISTICS</b>					
DC Current Gain ( $I_C = -5.0\text{ mA dc}$ , $V_{CE} = -10\text{ Vdc}$ ) ( $I_C = -500\text{ mA dc}$ , $V_{CE} = -1.0\text{ Vdc}$ ) ( $I_C = -1.0\text{ A dc}$ , $V_{CE} = -1.0\text{ Vdc}$ )	$h_{FE}$	50 85 60	— — —	— 375 —	—
Collector-Emitter Saturation Voltage ( $I_C = -1.0\text{ A dc}$ , $I_B = -100\text{ mA dc}$ )	$V_{CE(sat)}$	—	—	-0.5	Vdc
Base-Emitter On Voltage ( $I_C = -1.0\text{ A dc}$ , $V_{CE} = -1.0\text{ Vdc}$ )	$V_{BE(on)}$	—	—	-1.0	Vdc
<b>DYNAMIC CHARACTERISTICS</b>					
Current-Gain — Bandwidth Product ( $I_C = -10\text{ mA dc}$ , $V_{CE} = -5.0\text{ Vdc}$ )	$f_T$	—	60	—	MHz

### TYPICAL ELECTRICAL CHARACTERISTICS

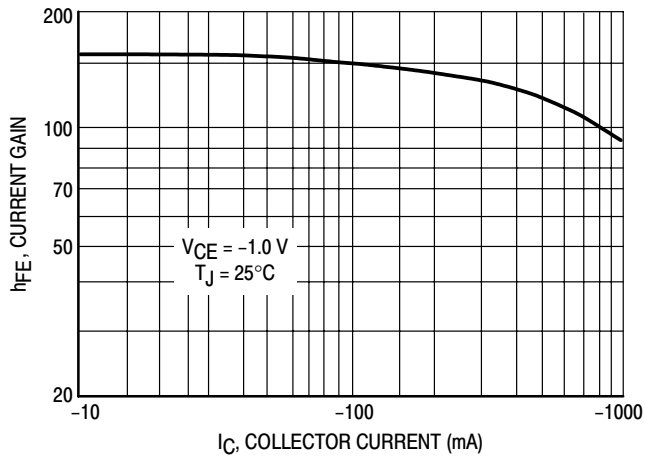

Figure 1. DC Current Gain

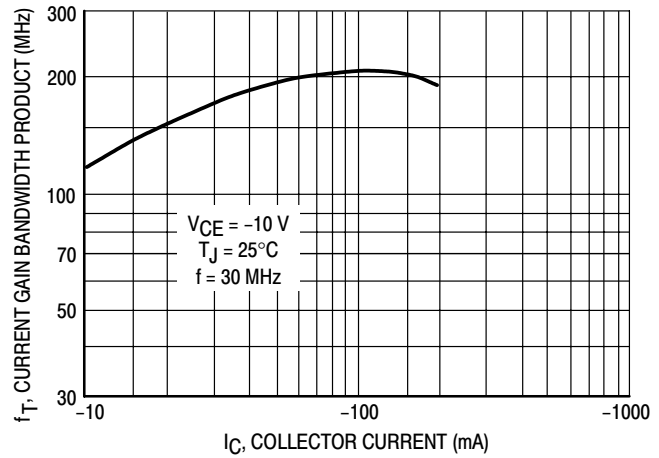

Figure 2. Current Gain Bandwidth Product

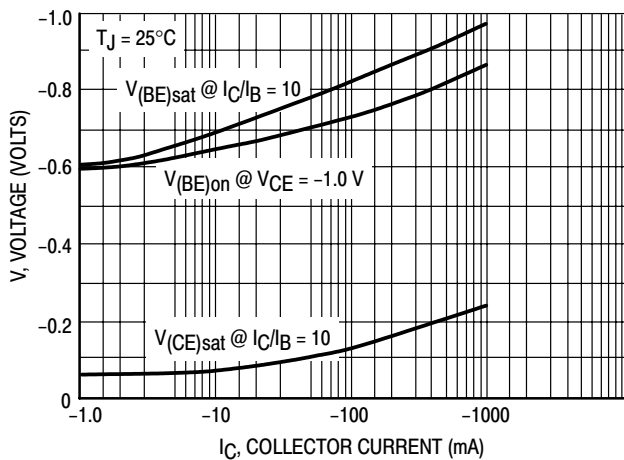

Figure 3. Saturation and "ON" Voltages

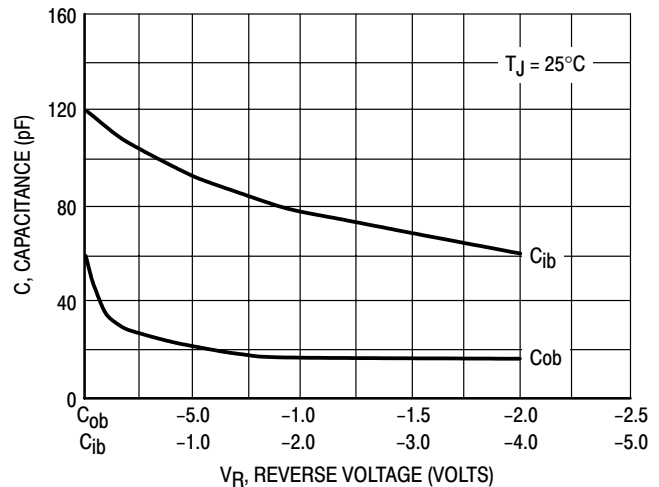

Figure 4. Capacitances

## INFORMATION FOR USING THE SOT-223 SURFACE MOUNT PACKAGE

### MINIMUM RECOMMENDED FOOTPRINT FOR SURFACE MOUNTED APPLICATIONS

Surface mount board layout is a critical portion of the total design. The footprint for the semiconductor packages must be the correct size to insure proper solder connection

interface between the board and the package. With the correct pad geometry, the packages will self align when subjected to a solder reflow process.

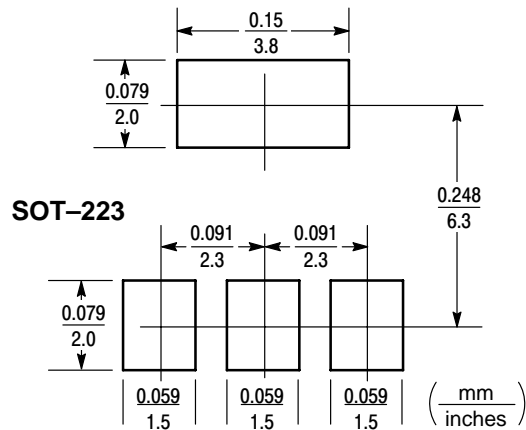

### SOT-223 POWER DISSIPATION

The power dissipation of the SOT-223 is a function of the pad size. This can vary from the minimum pad size for soldering to the pad size given for maximum power dissipation. Power dissipation for a surface mount device is determined by  $T_{J(max)}$ , the maximum rated junction temperature of the die,  $R\theta_{JA}$ , the thermal resistance from the device junction to ambient; and the operating temperature,  $T_A$ . Using the values provided on the data sheet for the SOT-223 package,  $P_D$  can be calculated as follows.

$$P_D = \frac{T_{J(max)} - T_A}{R\theta_{JA}}$$

The values for the equation are found in the maximum ratings table on the data sheet. Substituting these values into

the equation for an ambient temperature  $T_A$  of 25°C, one can calculate the power dissipation of the device which in this case is 1.5 watts.

$$P_D = \frac{150^\circ\text{C} - 25^\circ\text{C}}{83.3^\circ\text{C/W}} = 1.50 \text{ watts}$$

The 83.3°C/W assumes the use of the recommended footprint on a glass epoxy printed circuit board to achieve a power dissipation of 1.5 watts. Another alternative would be to use a ceramic substrate or an aluminum core board such as Thermal Clad™. Using a board material such as Thermal Clad, a higher power dissipation of 1.6 watts can be achieved using the same footprint.

### SOLDERING PRECAUTIONS

The melting temperature of solder is higher than the rated temperature of the device. When the entire device is heated to a high temperature, failure to complete soldering within a short time could result in device failure. Therefore, the following items should always be observed in order to minimize the thermal stress to which the devices are subjected.

- Always preheat the device.
- The delta temperature between the preheat and soldering should be 100°C or less.\*
- When preheating and soldering, the temperature of the leads and the case must not exceed the maximum temperature ratings as shown on the data sheet. When using infrared heating with the reflow soldering method, the difference should be a maximum of 10°C.

- The soldering temperature and time should not exceed 260°C for more than 10 seconds.
- When shifting from preheating to soldering, the maximum temperature gradient should be 5°C or less.
- After soldering has been completed, the device should be allowed to cool naturally for at least three minutes. Gradual cooling should be used as the use of forced cooling will increase the temperature gradient and result in latent failure due to mechanical stress.
- Mechanical stress or shock should not be applied during cooling

\* Soldering a device without preheating can cause excessive thermal shock and stress which can result in damage to the device.

# BCP69T1

## PACKAGE DIMENSIONS

### SOT-223 (TO-261) CASE 318E-04 ISSUE K

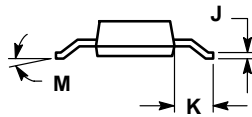
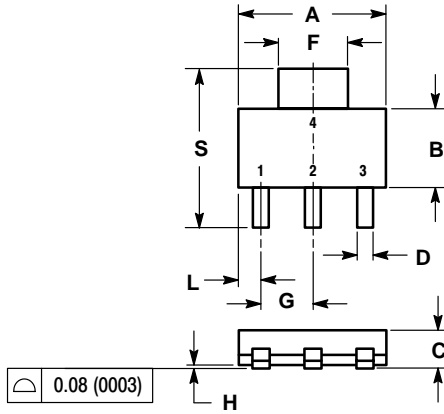

STYLE 1:  
PIN 1: BASE  
2: COLLECTOR  
3: EMITTER  
4: COLLECTOR

- NOTES:  
1. DIMENSIONING AND TOLERANCING PER ANSI Y14.5M, 1982.  
2. CONTROLLING DIMENSION: INCH.

DIM	INCHES		MILLIMETERS	
	MIN	MAX	MIN	MAX
A	0.249	0.263	6.30	6.70
B	0.130	0.145	3.30	3.70
C	0.060	0.068	1.50	1.75
D	0.024	0.035	0.60	0.89
F	0.115	0.126	2.90	3.20
G	0.087	0.094	2.20	2.40
H	0.0008	0.0040	0.020	0.100
J	0.009	0.014	0.24	0.35
K	0.060	0.078	1.50	2.00
L	0.033	0.041	0.85	1.05
M	0°	10°	0°	10°
S	0.264	0.287	6.70	7.30

Thermal Clad is a trademark of the Bergquist Company.

**ON Semiconductor** and  are trademarks of Semiconductor Components Industries, LLC (SCILLC). SCILLC reserves the right to make changes without further notice to any products herein. SCILLC makes no warranty, representation or guarantee regarding the suitability of its products for any particular purpose, nor does SCILLC assume any liability arising out of the application or use of any product or circuit, and specifically disclaims any and all liability, including without limitation special, consequential or incidental damages. "Typical" parameters which may be provided in SCILLC data sheets and/or specifications can and do vary in different applications and actual performance may vary over time. All operating parameters, including "Typicals" must be validated for each customer application by customer's technical experts. SCILLC does not convey any license under its patent rights nor the rights of others. SCILLC products are not designed, intended, or authorized for use as components in systems intended for surgical implant into the body, or other applications intended to support or sustain life, or for any other application in which the failure of the SCILLC product could create a situation where personal injury or death may occur. Should Buyer purchase or use SCILLC products for any such unintended or unauthorized application, Buyer shall indemnify and hold SCILLC and its officers, employees, subsidiaries, affiliates, and distributors harmless against all claims, costs, damages, and expenses, and reasonable attorney fees arising out of, directly or indirectly, any claim of personal injury or death associated with such unintended or unauthorized use, even if such claim alleges that SCILLC was negligent regarding the design or manufacture of the part. SCILLC is an Equal Opportunity/Affirmative Action Employer.

## PUBLICATION ORDERING INFORMATION

### Literature Fulfillment:

Literature Distribution Center for ON Semiconductor  
P.O. Box 5163, Denver, Colorado 80217 USA  
Phone: 303-675-2175 or 800-344-3860 Toll Free USA/Canada  
Fax: 303-675-2176 or 800-344-3867 Toll Free USA/Canada  
Email: ONlit@hibbertco.com

**N. American Technical Support:** 800-282-9855 Toll Free USA/Canada

**JAPAN:** ON Semiconductor, Japan Customer Focus Center  
4-32-1 Nishi-Gotanda, Shinagawa-ku, Tokyo, Japan 141-0031  
Phone: 81-3-5740-2700  
Email: r14525@onsemi.com

**ON Semiconductor Website:** <http://onsemi.com>

For additional information, please contact your local Sales Representative.