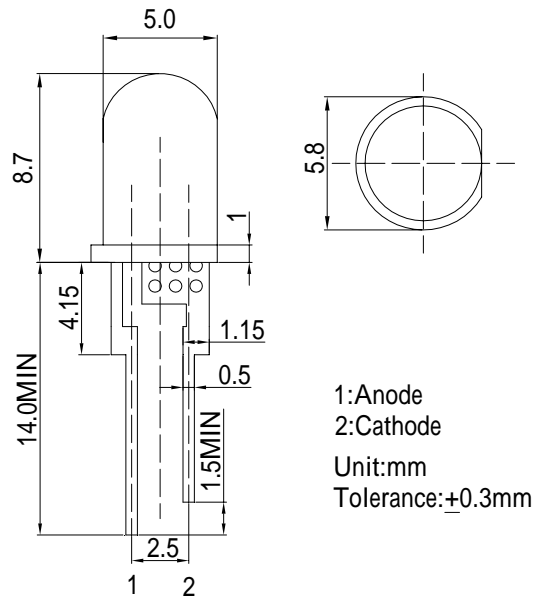

■Features

- Highest luminous flux
- Super energy efficiency
- Long Lifetime Operation
- Low Thermal resistance
- Water Clear Type

■Applications

- Read lights (car, bus, aircraft)
- Bollards / Security / Garden
- Small Area Illuminations
- In door / Out door Commercial lights
- Automotive Ext

■Outline Dimension

■Absolute Maximum Rating

(Ta=25)

Item	Symbol	Value	Unit
DC Forward Current	I_F	120	mA
Pulse Forward Current*	I_{FP}	200	mA
Reverse Voltage	V_R	5	V
Power Dissipation	P_D	480	mW
Operating Temperature	T_{opr}	-30 ~ +85	
Storage Temperature	T_{stg}	-40~ +100	
Lead Soldering Temperature	T_{sol}	260 /5sec	-

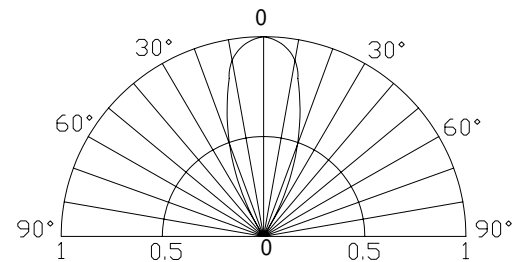
*Pulse width Max.10ms Duty ratio max 1/10

■Directivity

■Electrical -Optical Characteristics

(Ta=25)

Item	Symbol	Condition	Min.	Typ.	Max.	Unit
DC Forward Voltage	V_F	$I_F=100mA$	3.0	3.3	4.0	V
DC Reverse Current	I_R	$V_R=5V$	-	-	10	μA
Domi. Wavelength*	λ_D	$I_F=100mA$	465	470	475	nm
Luminous Intensity*	I_V	$I_F=100mA$	-	6500	-	mcd
50% Power Angle	$2\theta_{1/2}$	$I_F=100mA$	-	40	-	deg

 *1 Tolerance of dominant wavelength is $\pm 1nm$

 *2 Tolerance of luminous intensity is $\pm 15\%$