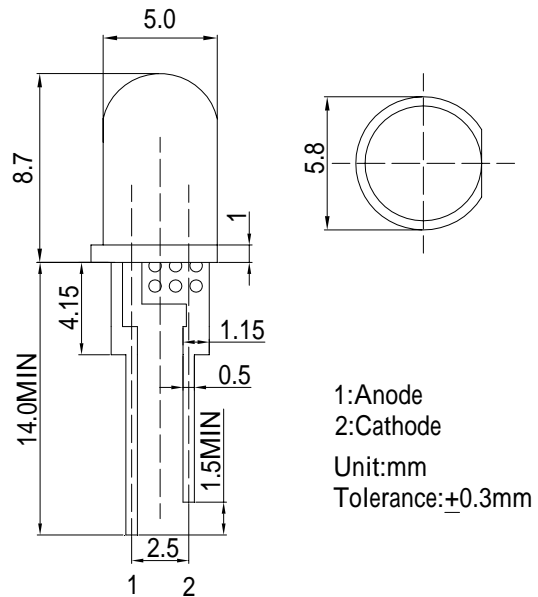

**■Features**

- Highest luminous flux
- Super energy efficiency
- Low Thermal resistance
- Water Clear Type

**■Applications**

- Read lights (car, bus, aircraft)
- Bollards / Security / Garden
- Small Area Illuminations
- In door / Out door Commercial lights
- Automotive Ext

**■Outline Dimension**

**■Absolute Maximum Rating**

(Ta=25 )

Item	Symbol	Value	Unit
DC Forward Current	I <sub>F</sub>	120	mA
Pulse Forward Current*	I <sub>FP</sub>	200	mA
Reverse Voltage	V <sub>R</sub>	5	V
Power Dissipation	P <sub>D</sub>	480	mW
Operating Temperature	Topr	-30 ~ +85	
Storage Temperature	Tstg	-40~ +100	
Lead Soldering Temperature	Tsol	260 /5sec	-

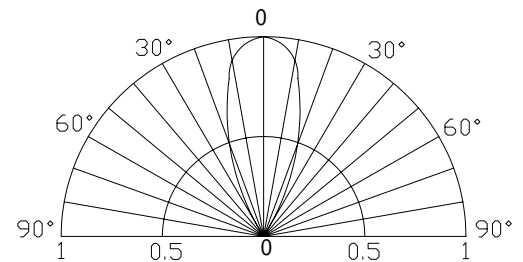
\*Pulse width Max.10ms Duty ratio max 1/10

**■Directivity**

**■Electrical -Optical Characteristics**

(Ta=25 )

Item	Symbol	Condition	Min.	Typ.	Max.	Unit
DC Forward Voltage	V <sub>F</sub>	I <sub>F</sub> =100mA	3.0	3.3	4.0	V
DC Reverse Current	I <sub>R</sub>	V <sub>R</sub> =5V	-	-	10	μA
Domi. Wavelength*	λ <sub>D</sub>	I <sub>F</sub> =100mA	520	525	530	nm
Luminous Intensity*	I <sub>V</sub>	I <sub>F</sub> =100mA	-	20000	-	mcd
50% Power Angle	2θ <sub>1/2</sub>	I <sub>F</sub> =100mA	-	40	-	deg

\*1 Tolerance of dominant wavelength is ±1nm

\*2 Tolerance of luminous intensity is ±15%