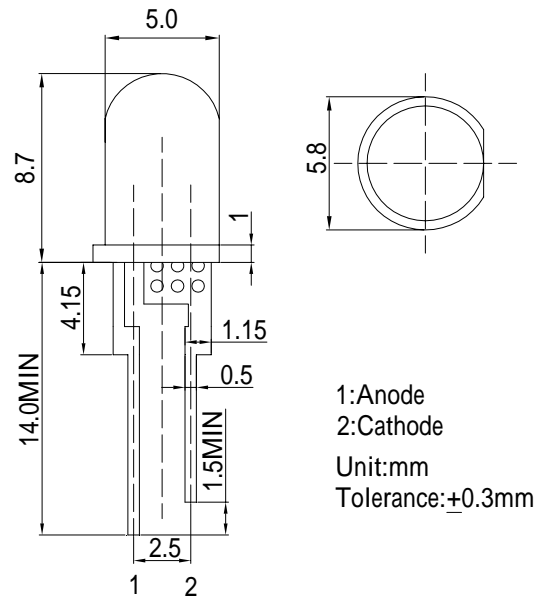

■Features

- Highest luminous flux
- Super energy efficiency
- Long Lifetime Operation
- Low Thermal resistance
- Water Clear Type

■Applications

- Read lights (car, bus, aircraft)
- Bollards / Security / Garden
- Small Area Illuminations
- In door / Out door Commercial lights
- Automotive Ext

■Outline Dimension

■Absolute Maximum Rating

(Ta=25)

Item	Symbol	Value	Unit
DC Forward Current	I _F	120	mA
Pulse Forward Current*	I _{FP}	200	mA
Reverse Voltage	V _R	5	V
Power Dissipation	P _D	480	mW
Operating Temperature	Topr	-30 ~ +85	
Storage Temperature	Tstg	-40~ +100	
Lead Soldering Temperature	Tsol	260 /5sec	-

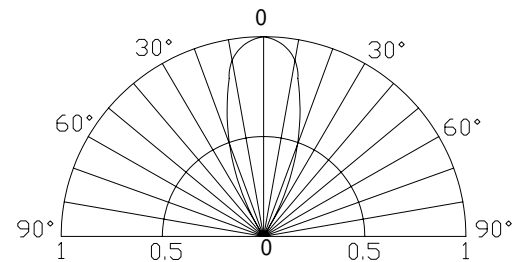
*Pulse width Max.10ms Duty ratio max 1/10

■Directivity

■Electrical -Optical Characteristics

(Ta=25)

Item	Symbol	Condition	Min.	Typ.	Max.	Unit
DC Forward Voltage	V _F	I _F =100mA	3.0	3.3	4.0	V
DC Reverse Current	I _R	V _R =5V	-	-	10	μA
Luminous Intensity*	I _v	I _F =100mA	-	2100	-	mcd
Chromaticity Coordinates*	x	I _F =100mA	-	0.45	-	
	y	I _F =100mA	-	0.17	-	
50% Power Angle	2θ _{1/2}	I _F =100mA	-	40	-	deg

*1 Tolerance of chromaticity coordinates is ±10%

*2 Tolerance of luminous intensity is ±15%