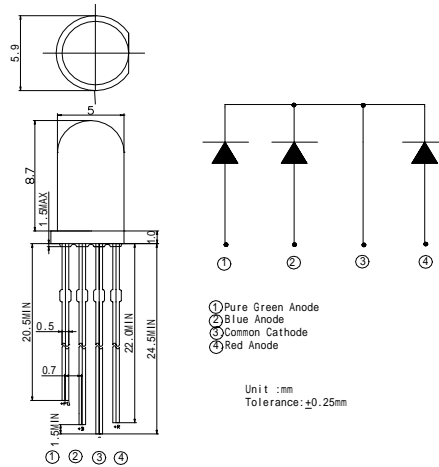

■Features

- High Luminous Output
- 5mm Standard Directivity
- Superior Weather-resistance
- White Clear Type

■Applications

- Toys
- Games
- Audio

■Outline Dimension

■Absolute Maximum Rating (Ta=25 °C)

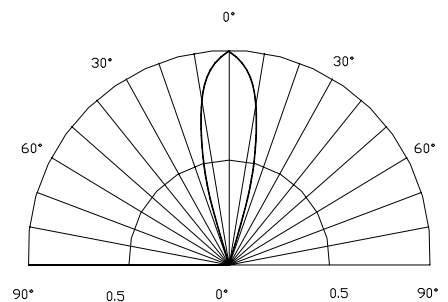
Item	Symbol	Value	Unit
DC Forward Current	I_F	30	mA
Pulse Forward Current*	I_{FP}	100	mA
Reverse Voltage	V_R	5	V
Power Dissipation	P_D	120	mW
Operating Temperature	T_{opr}	-30 ~ +80	
Storage Temperature	T_{stg}	-30 ~ +100	
Lead Soldering Temperature	T_{sol}	260 /5sec	-

■Directivity

■Electrical -Optical Characteristics (Ta=25 °C)

Item	Symbol	Condition	Min.	Typ.	Max.	Unit
DC Forward Voltage	V_F (R)	$I_F=20mA$	1.8	2.0	2.4	V
	V_F (B/G)	$I_F=20mA$	2.8	3.4	4.0	V
DC Reverse Current	I_R	$V_R=5V$	-	-	10	μA
Domi. Wavelength	λ_D (Red)	$I_F=20mA$	635	640	645	nm
	λ_D (Green)	$I_F=20mA$	520	525	530	nm
	λ_D (Blue)	$I_F=20mA$	465	470	475	nm
Luminous Intensity	I_v (Red)	$I_F=20mA$	1560	2180	3000	mcd
	I_v (Green)	$I_F=20mA$	3000	4200	5800	mcd
	I_v (Blue)	$I_F=20mA$	2180	3000	4200	mcd
50% Power Angle	$2\theta_{1/2}$	$I_F=20mA$	-	30	-	deg