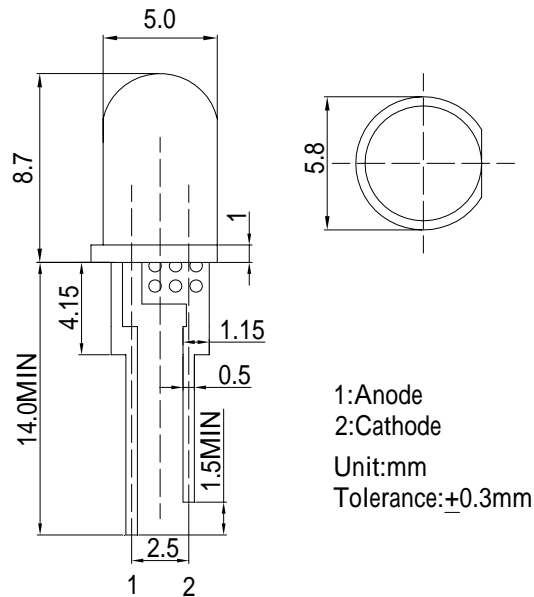

■Features

- Highest luminous flux
- Super energy efficiency
- Low Thermal resistance
- Water Clear Type

■Applications

- Read lights (car, bus, aircraft)
- Bollards / Security / Garden
- Small Area Illuminations
- In door / Out door Commercial lights
- Automotive Ext

■Outline Dimension

■Absolute Maximum Rating

(Ta=25)

Item	Symbol	Value	Unit
DC Forward Current	I _F	120	mA
Pulse Forward Current*	I _{FP}	200	mA
Reverse Voltage	V _R	5	V
Power Dissipation	P _D	360	mW
Operating Temperature	T _{opr}	-30 ~ +85	
Storage Temperature	T _{stg}	-40~ +100	
Lead Soldering Temperature	T _{sol}	260 /5sec	-

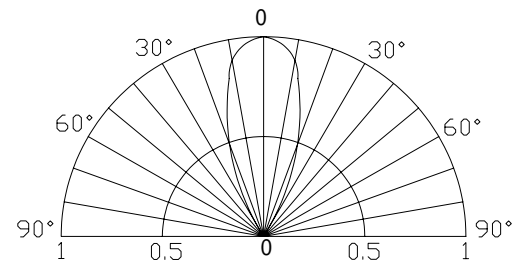
*Pulse width Max.10ms Duty ratio max 1/10

■Directivity

■Electrical -Optical Characteristics

(Ta=25)

Item	Symbol	Condition	Min.	Typ.	Max.	Unit
DC Forward Voltage	V _F	I _F =100mA	2.0	2.5	3.0	V
DC Reverse Current	I _R	V _R =5V	-	-	10	μA
Domi. Wavelength*	λ _D	I _F =100mA	585	590	595	nm
Luminous Intensity*	I _v	I _F =100mA	-	13000	-	mcd
50% Power Angle	2θ _{1/2}	I _F =100mA	-	40	-	deg

*1 Tolerance of dominant wavelength is ±1nm

*2 Tolerance of luminous intensity is ±15%