

FHS2828 Series

■ Wire Wound Common Mode Filter

MECHANICAL DIMENSIONS

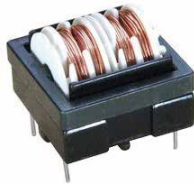

FHS2828

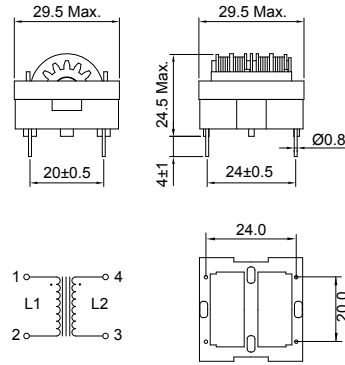

unit: mm

ELECTRICAL SPECIFICATION

Part Number	Inductance (mH) Min.	DCR (Ω) Max.	Rated Current (A)
FHS2828R-332IN	3.3	0.12	3.0
FHS2828R-562IN	5.6	0.16	2.5
FHS2828R-802IN	8.0	0.16	2.0
FHS2828R-163IN	16	0.40	1.5
FHS2828R-393IN	39	0.65	1.0
FHS2828R-453IN	45	0.80	0.9
FHS2828R-603IN	60	1.00	0.8
FHS2828R-683IN	68	1.50	0.7
FHS2828R-963IN	96	2.00	0.6
FHS2828R-124IN	120	2.50	0.5

- Inductance measurement condition: 1 KHz at 25°C
- Withstanding voltage: 1.5KV, one minute between line.
- Temperature rise: 45°C max.

SMD

Leaded