

Version No.:2013001

Spec. No.: SFA-MTS

# 规格承认书

## Specification for approval

产品名称： MTS 系列 慢断型 微型塑封保险丝

**Product Type: MTS Series *Time-Lag Radial Lead Micro Fuse***

## 目录 Contents

1. 适用范围 / Scope of Application.....	3
2. 安规认证标准及编号 / Standards and Agency Approvals.....	3
3. 产品标示 / Product Marking.....	4
4. 外观及形状 / Appearances and Configuration.....	5
5. 结构及尺寸 / Dimensions and Structure.....	6
6. 材料明细 / Material Details.....	6
7. 产品特性 / Product Characteristics.....	7
8. 电气特性 / Electrical Characteristics.....	7
9. 环境特性 / Environmental Characteristic.....	9
10. 安装建议 / Installation Recommendations.....	9
11. 包装 / Packaging.....	10
12. 其他 / Others.....	12
附件 I: 安规证书 / Appendix I: Safety approval certificates.....	12

## 1. 适用范围 / Scope of Application

本产品适用于各类电子设备电路的过流保护作用, 广泛应用于电池充电、消费电子、电源供应、工业控制器等领域。

This product is suitable for various kinds of electronic devices' circuit over current protection. Widely used in industrial of Battery Charges, Consumer Electronics, Power supplies, Industrial Controllers, etc.

## 2. 安规认证标准及编号 / Standards and Agency Approvals





2.1 执行标准: 遵循 IEC60127-1, IEC60127-3 标准规格单 4, GB9364.1-1997, GB9364.3-1997。

Standards : In accordance with IEC60127-1, IEC60127-3 Standard sheet4, GB9364.1-1997, GB9364.3-1997.

### 2.2 认证范围 Certification:

安规标准 Agency	认证范围 Ampere Range	证书编号 Agency File Number
UR	50mA ~ 6.3A	E340427(JDYX2)
C-UR	50mA ~ 6.3A	E340427(JDYX8)
VDE	50mA ~ 6.3A	Pending
CQC	50mA ~ 6.3A	CQC11012061981
PSE	50mA ~ 6.3A	Pending
KTL	50mA ~ 6.3A	Pending

### 2.3 目录编号 Catalogue No., ● 已认证 Approved / ○ 认证中 Pending







目录编号 Catalog No.	额定电流 Ampere Rating	额定电压 Voltage Rating	最大电压降 Max Voltage Drop (mv)	熔化热能 I <sup>2</sup> TMelting Integral(A <sup>2</sup> .S)	安规认证 Agency Approvals				
									
MTS0050A	50mA	250V	-	-	●	○	●	○	○
MTS0100A	100mA	250V	3500	-	●	○	●	○	○
MTS0125A	125mA	250V	2000	-	●	○	●	○	○

MTS0160A	160mA	250V	2000	-	●	○	●	○	○
MTS0200A	200mA	250V	1700	0.04	●	○	●	○	○
MTS0250A	250mA	250V	1400	0.06	●	○	●	○	○
MTS0315A	315mA	250V	1300	0.10	●	○	●	○	○
MTS0400A	400mA	250V	1200	0.20	●	○	●	○	○
MTS0500A	500mA	250V	1100	0.35	●	○	●	○	○
MTS0630A	630mA	250V	650	0.50	●	○	●	○	○
MTS0800A	800mA	250V	240	1.3	●	○	●	○	○
MTS1100A	1A	250V	200	1.6	●	○	●	○	○
MTS1125A	1.25A	250V	200	2.4	●	○	●	○	○
MTS1160A	1.6A	250V	190	4.6	●	○	●	○	○
MTS1200A	2A	250V	170	7.9	●	○	●	○	○
MTS1250A	2.5A	250V	170	12	●	○	●	○	○
MTS1315A	3.15A	250V	150	22	●	○	●	○	○
MTS1400A	4A	250V	130	29	●	○	●	○	○
MTS1500A	5A	250V	130	78	●	○	●	○	○
MTS1630A	6.3A	250V	130	97	●	○	●	○	○
MTS1800A	8A	250V	100	290	○	○	○	○	○
MTS2100A	10A	250V	100	430	○	○	○	○	○

### 3. 产品标示 / Product Marking

保险丝上需有下列标示 / The fuses shall have the following markings:

示例 Example:

	MTS	T	1A	250V	    
①	②	③	④	⑤	⑥

①	制造厂商标识/Reomax Trade Mark: 
②	系列型号名称/Series Type Name: <b>MTS</b>
③	电器特性符号/ Electrical Characteristic symbol: <b>T</b> (慢断型保险丝符号/symbol for Time-Lag)
④	额定电流/Rated Current (A): ___A 或 or ___mA
⑤	额定电压/Rated Voltage (V): <b>250V</b>
⑥	认证符号/ Approval Marks:



**注意 / Note:**

对于标示的大小和位置没有规定 / Size and position of the markings shall not be provided.

#### 4. 外观及形状 / Appearances and Configuration

4.1 外观不应出现显著的污点、铁锈或裂纹，标识应该容易辨识。

There shall not be any remarkable stain, rust or crack on the appearances,  
Markings shall be easily legible.

4.2 形状：带直线引脚的超小型保险丝。

Configuration: Radial leaded Sub-Miniature Fuse.

4.3 颜色：黑色或者棕色。

Color: Black or brown.

## 5. 结构及尺寸 / Dimensions and Structure

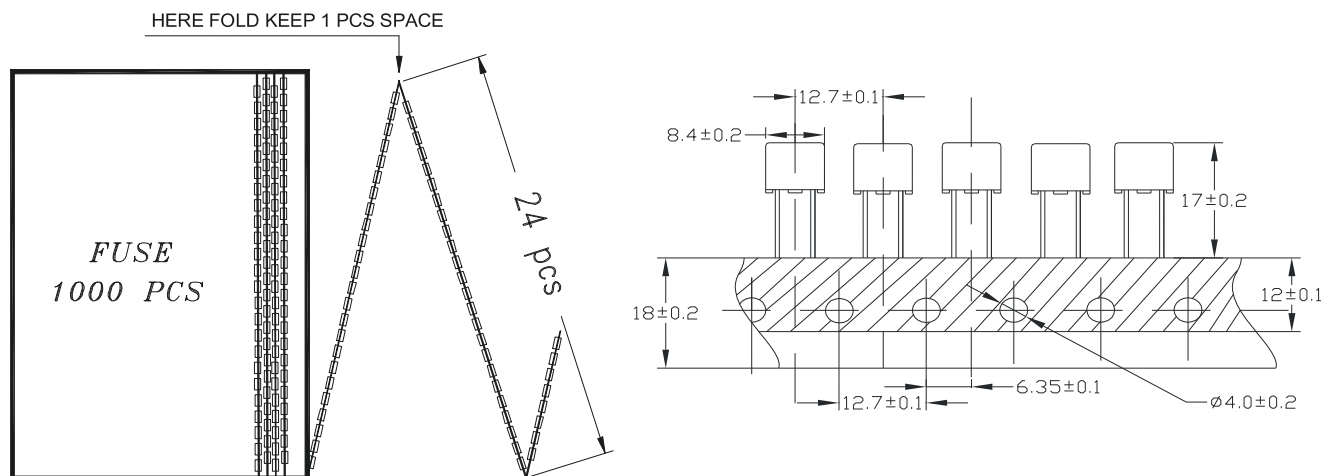

BOX SIZE 328mm\*197mm\*40mm

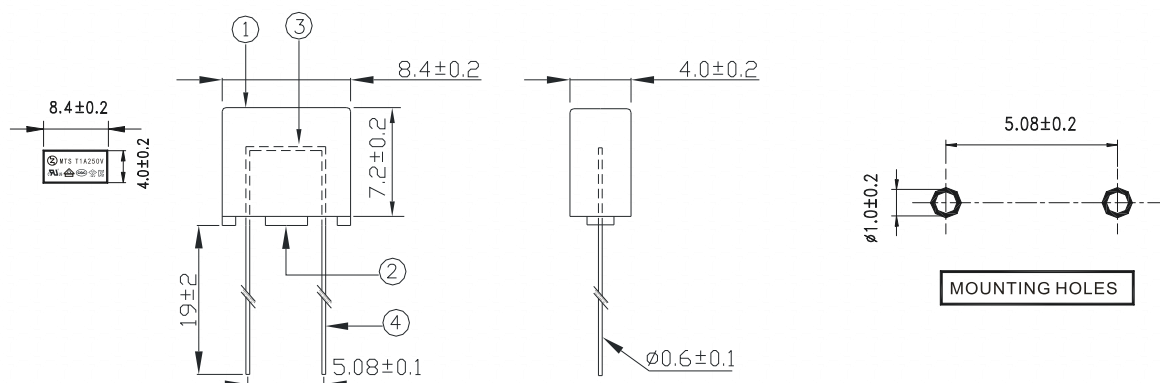

## 6. 材料明细 / Material Details

编号 NO.	零件名称 Part Name	材质 Material
①	外壳 Cap	黑色或棕色热可塑性聚酰胺 (UL94-V0) Black or Brown Thermoplastic Polyamide PA 6.6, UL 94 V-0
②	内芯 Base	黑色或棕色热可塑性聚酰胺 (UL94-V0) Black or Brown Thermoplastic Polyamide PA 6.6, UL 94 V-0
③	熔丝 Fuse element	合金 Alloy
④	引线 Lead wire	镀锡铜线 Copper, Tin-plated

## 7. 产品特性 / Product Characteristics

### 7.1 引脚拉力强度 / Lead Pull Strength

5 牛顿 10±1 秒 / 5N for 10±1 Seconds

### 7.2 引脚推力强度 / Lead Thrust Strength

2 牛顿 10±1 秒 / 2N for 10±1 Seconds

### 7.3 可焊性 / Solder ability

波峰焊/Wave : 260℃, ≤3s;

烙铁焊/Soldering Iron: 350±10℃, ≤1s.

### 7.4 耐焊接热 / Soldering Heat Resistance

波峰焊/Wave : 260℃, 10s;

烙铁焊/Soldering Iron: 350℃, 3s.

## 8. 电气特性 / Electrical Characteristics

### 8.1 实验条件: Test Condition

所有测试环境温度为 25±5℃。

All electrical test is to be conducted with the ambient air at a temperature of 25±5℃.

### 8.2 分断能力 Interrupting Rating:

保险丝承受分断能力: 在 250 伏交流电源下, 35A 或 10 倍的额定电流当中较大的。

分断能力测试后保险丝的绝缘阻抗值大于 0.1MΩ。

Breaking Capacity: 35A or 10In whichever is greater at 250V AC.

The insulation resistance value of fuse is greater than 0.1MΩ after breaking capacity testing.

### 8.3 温度上升试验 Rising Temperature Test:

通 1.5 倍额定电流 15 分钟, 然后每隔 15 分钟增加 0.1 倍额定电流。测得熔断体断开时任何部位的温升不得超过 135℃, 周围环境温度为 25±5℃。

Under the ambient temperature of 25±5℃, through 1.5 times the rated current for 15 minutes, then every 15 minutes, add an increase of 0.1 times the rated current. When operates, the temperature rise in any part of fuse should not exceed 135℃.

### 8.4 熔断时限 / Operating Characteristics

额定电流的% % of Ampere Rating(In)	熔断时间 Blowing Time
150%* In	大于 60 分钟 (60 min Minimum)
210%* In	小于 2 分钟 (2 min Max)
275%* In	400 毫秒至 10 秒 (400 ms~10 s)
400%* In	150 毫秒至 3 秒 (150 ms~3 s)
1000%* In	20 毫秒至 150 毫秒 (20 ms~150 ms)

### 8.5 平均时间电流曲线图 / Average Time Current Curves

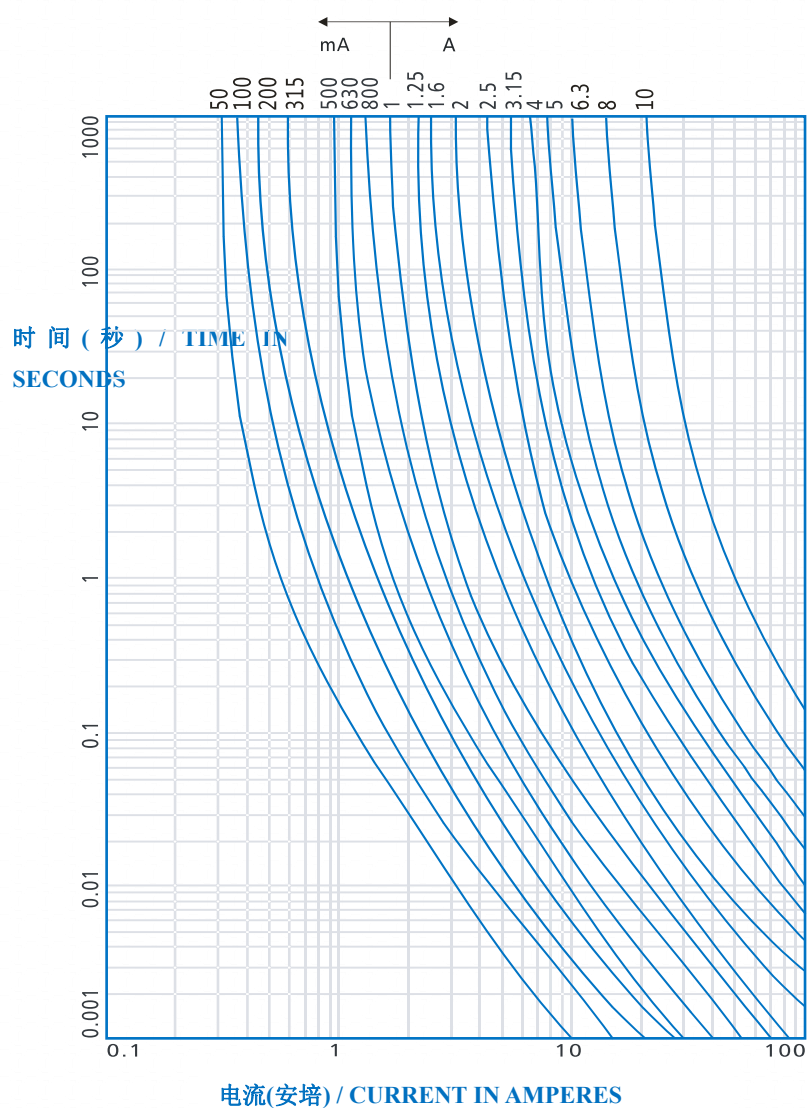



## 9. 环境特性 / Environmental Characteristic

### 9.1 使用温度范围 Operating Temperature

-55℃~+125℃。

### 9.2 保存条件 Stock Condition

湿度：相对湿度 $\leq 75\%$ 平均可以存放3年。

Humidity: Relative humidity  $\leq 75\%$  store 3 years average.

### 9.3 若操作环境温度超出 $25 \pm 5^\circ\text{C}$ 范围，在选用保险丝规格时，需考虑操作环境温度对保险丝的影响，请参照如下：温度-电流曲线图。

When choosing the fuse's specification, if the operating environmental temperature beyond the scope from  $20\sim 30^\circ\text{C}$ , engineer should consider the environmental temperature's affection to fuses.

Please refer: Temperature Rerating Curve:

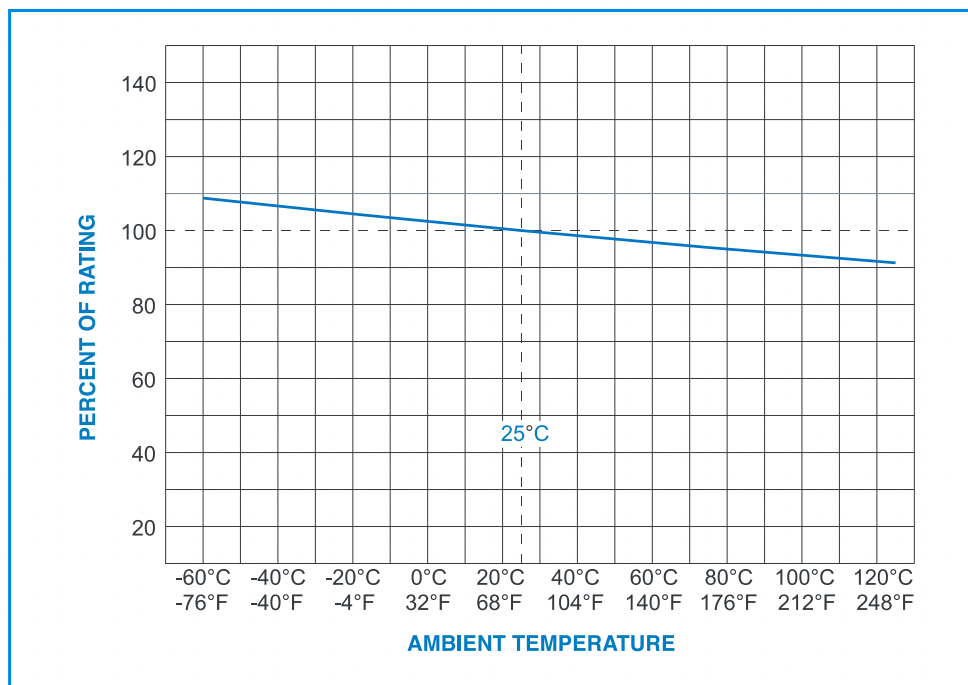

## 10. 安装建议 / Installation Recommendations

### 10.1 建议按照如下示意图方式进行安装。

Propose installation way as following picture.

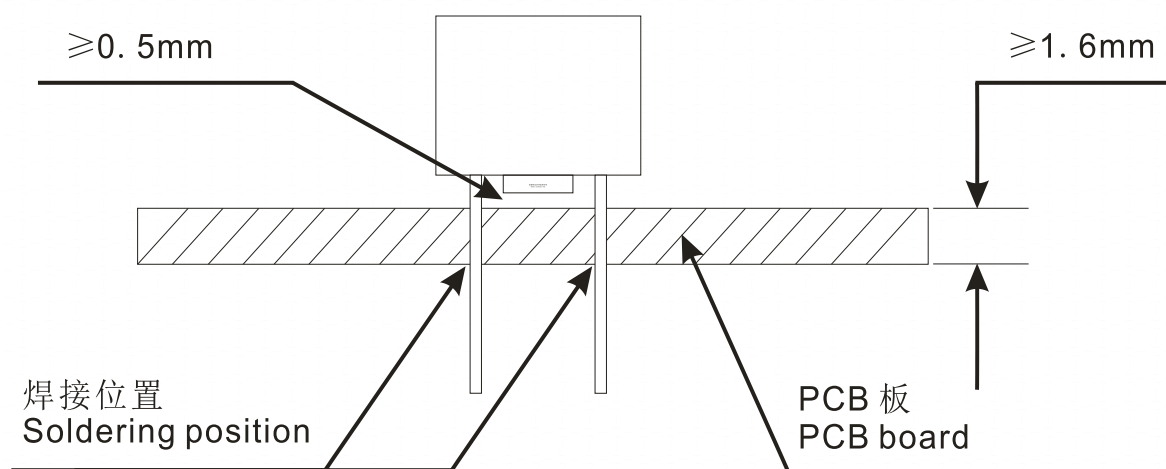

## 10.2 建议焊接参数 / Recommended Soldering Parameters

### A. 波峰焊参数 / Wave Parameters:

锡炉温度 / Solder Pot Temperature:  $260^{\circ}\text{C}$  Max

焊接时间 / Solder Dwell Time: 2~5s

### B. 手工焊参数 / Hand-Solder Parameters:

烙铁温度 / Solder Iron Temperature:  $350 \pm 5^{\circ}\text{C}$

焊接时间 / Heating Time: 1~2 s Max

## 11. 包装 / Packaging

### 11.1 包装袋/盒印明下列标示: / The following items indicated on the label:

产品料号、额定(电压、电流)、分断类型及安规名称。

Catalog number, ratings (voltage, current), interrupting type and safety mark.

包装材料均符合 RoHS/REACH/HF 的环保要求，且包装材料不会和零件发生化学反应，造成不良。

The packing material conforms to ROHS/REACH/HF environmental protection request. And the packing materials will not have the chemical reaction with the components.

### 11.2 包装数量 / Packing Quantity

A. 散装 / Bulk packing:

每胶袋 250 个保险丝 / Bulk 250 pcs in per poly bag;

每 10 胶袋 1 个内盒 / 10 poly bags in per inner box;

每 4 个内盒 1 个外箱 / 4 inner boxes in per outer carton

B. 编带包装/ Taped packing:

每个内盒 1000 个保险丝/ 1000 pcs per inner box

每 10 内盒 1 个外箱 / 10 inner boxes per outer carton

11.3 包装箱尺寸 / Packing Size

单位: 毫米 / Unit: mm

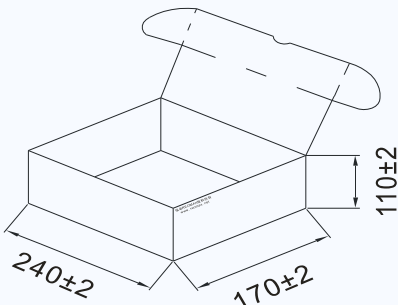
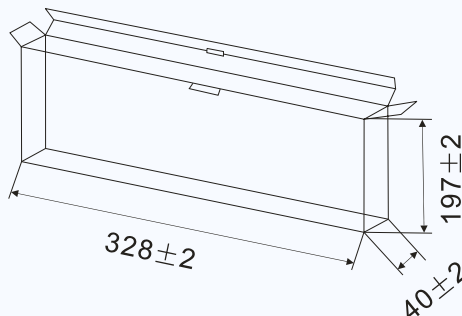
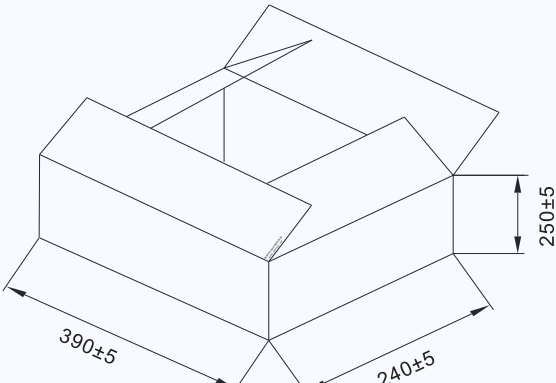
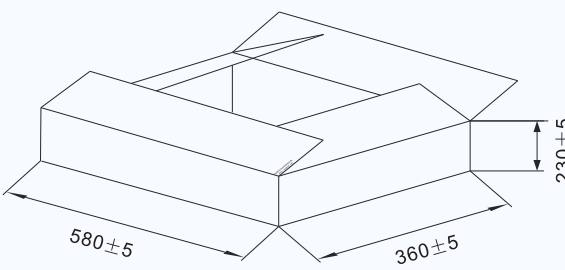
散装内盒 Inner box of packing type A:	编带内盒 Inner box of packing type B:
L240±2 * W170±2 * H110±2	L328±2 * W197±2 * H40±2
	
散装外箱 Outer carton of packing type A	编带外箱 Outer carton of packing type B
L390±5 * W240±5 * H250±5	L580±5 * W360±5 * H230±5
	

## 12. 其他 / Others

12.1 如果在使用中有超出本规格书的要求，须经双方协商确认。

In the event that an impropriety is found beyond this specification, it shall be fixed by mutual agreement between the parties.

12.2 如果本规格书有不适当的情况，须通过双方协商并由本公司修改。

In the event that an impropriety is found in this specification, *REOMAX ELECTRONIC CO., LTD.* shall amend it by mutual agreement between the parties.

## 附件 I: 安规证书 / Appendix I: Safety approval certificates