

PC930 Series

Digital Output, High Sensitivity Type OPIC Photocoupler

■ Features

1. High sensitivity
(I_{FLH} , I_{FHL} : MAX. 1mA)
2. TTL and LSTTL compatible output
3. Operating supply voltage range
(V_{CC} : 4.5 to 15V, **PC930/PC931/PC932/PC933**)
4. Various output forms
(Open collector output, pull-up resistor built-in type, totem pole output)
5. Low output current dissipation
(I_{CCL} : MAX. 3.8mA)
6. High isolation voltage between input and output (V_{ISO} : 5 000V_{rms})
7. Recognized by UL, file No. E64380

■ Model Line-up

	Open collector output type	Pull-up resistor built-in type	Totem pole output type
Low active	PC930	PC932	PC934
High active	PC931	PC933	PC935

■ Applications

1. Computer terminals
2. High speed line receivers
3. Interfaces with various data transmission equipment

■ Absolute Maximum Ratings

Parameter		Symbol	Rating	Unit	
Input	Forward current	I_F	20	mA	
	*1 Peak forward current	I_{FM}	1	A	
	Reverse voltage	V_R	6	V	
	Power dissipation	P	70	mW	
Output	Supply voltage	V_{CC}	PC930/PC931 PC932/PC933	- 0.5 to 16.0	V
			PC934/PC935	- 0.5 to 7.0	
			High level output voltage	PC930/PC931	
	High level output current	PC934/PC935	I_{OH}	- 800	μ A
	Low level output current	I_{OL}	50	mA	
	Power dissipation	P_O	150	mW	
Total power dissipation		P_{tot}	170	mW	
*2 Isolation voltage		V_{iso}	5 000	V _{rms}	
Operating temperature		T_{opr}	- 25 to + 85	°C	
Storage temperature		T_{stg}	- 40 to + 125	°C	
*3 Soldering temperature		T_{sol}	260	°C	

■ Outline Dimensions

(Unit : mm)

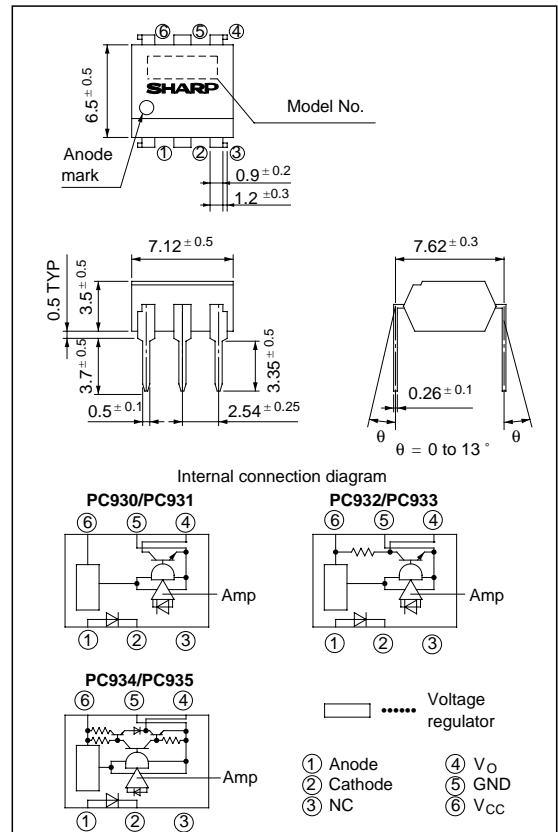

* "OPIC" (Optical IC) is a trademark of the SHARP Corporation.
 An OPIC consists of a light-detecting element and signal-processing circuit integrated onto a single chip.

*1 Pulse width $\leq 100 \mu$ s

Duty ratio : 0.001

*2 40 to 60% RH,

AC for 1 minute

*3 For 10 seconds

■ Electro-optical Characteristics

(Ta = 0 to + 70°C unless otherwise specified.)

Parameter		Symbol	Conditions	MIN.	TYP.	MAX.	Unit	
Input	Forward voltage	V_F	$I_F = 2\text{mA}$	-	1.1	1.4	V	
			$I_F = 0.1\text{mA}$	0.55	0.95	-	V	
	Reverse current	I_R	Ta = 25°C, $V_R = 3\text{V}$	-	-	10	μA	
	Terminal capacitance	C_t	Ta = 25°C, $V = 0$, $f = 1\text{kHz}$	-	30	250	pF	
Output	Operating supply voltage	V_{CC}	-	4.5	-	15	V	
				4.5	-	5.5	V	
	Low level output voltage	V_{OL}	-	$I_{OL} = 16\text{mA}$, $V_{CC} = 5\text{V}$, $I_F = 1\text{mA}$	-	0.15	0.4	V
				$I_{OL} = 16\text{mA}$, $V_{CC} = 5\text{V}$, $I_F = 0$				
				$I_{OL} = 16\text{mA}$, $V_{CC} = 4.5\text{V}$, $I_F = 1\text{mA}$				
				$I_{OL} = 16\text{mA}$, $V_{CC} = 4.5\text{V}$, $I_F = 0$				
	High level output voltage	V_{OH}	-	$V_{CC} = 5\text{V}$, $I_F = 0$	3.5	-	-	V
				$V_{CC} = 5\text{V}$, $I_F = 1\text{mA}$				
				$V_{CC} = 4.5\text{V}$, $I_F = 0$, $I_{OH} = -400\mu\text{A}$				
				$V_{CC} = 4.5\text{V}$, $I_F = 1\text{mA}$, $I_{OH} = -400\mu\text{A}$				
	High level output current	I_{OH}	-	$V_{CC} = V_O = 15\text{V}$, $I_F = 0$	-	-	100	μA
				$V_{CC} = V_O = 15\text{V}$, $I_F = 1\text{mA}$	-	-	100	μA
	Low level supply current	I_{CCL}	-	$V_{CC} = 5\text{V}$, $I_F = 1\text{mA}$	-	1.3	3.4	mA
				$V_{CC} = 5\text{V}$, $I_F = 0$	-	1.3	3.4	mA
				$V_{CC} = 5\text{V}$, $I_F = 1\text{mA}$	-	1.7	3.8	mA
				$V_{CC} = 5\text{V}$, $I_F = 0$	-	1.7	3.8	mA
	High level supply current	I_{CCH}	-	$V_{CC} = 5\text{V}$, $I_F = 0$	-	0.7	2.2	mA
$V_{CC} = 5\text{V}$, $I_F = 1\text{mA}$				-	0.7	2.2	mA	
Output short circuit current	I_{OS}	-	$V_{CC} = 5\text{V}$, $I_F = 0$, $T = \text{Within 1 second}$	6	17	35	mA	
			$V_{CC} = 5\text{V}$, $I_F = 1\text{mA}$, $T = \text{Within 1 second}$	6	17	35	mA	
Transfer characteristics	*4 "High→Low" Threshold input current	I_{FHL}	$V_{CC} = 5\text{V}$, $R_L = 280\Omega$	-	0.5	1.0	mA	
				0.1	0.4	-	mA	
				0.1	0.4	-	mA	
	*5 "Low→High" Threshold input current	I_{FLH}	$V_{CC} = 5\text{V}$, $R_L = 280\Omega$	-	0.5	1.0	mA	
				0.1	0.4	-	mA	
				0.1	0.4	-	mA	
	*6 Hysteresis	I_{FLH} / I_{FHL}	$V_{CC} = 5\text{V}$, $R_L = 280\Omega$	-	0.8	-	-	
		I_{FHL} / I_{FLH}		-	0.8	-	-	
	Isolation resistance		R_{ISO}	Ta = 25°C, DC500V, 40 to 60% RH	5×10^{10}	10^{11}	-	Ω
	Response time	"High→Low" propagation delay time	t_{PHL}	Ta = 25°C $V_{CC} = 5\text{V}$ $I_F = 1\text{mA}$ $R_L = 280\Omega$ Fig.1	-	3	9	μs
-					5	15		
"Low→High" propagation delay time		t_{PLH}	-		5	15		
			-		3	9		
Fall time		t_f	-		0.05	0.5		
Rise time		t_r	-		0.1	0.5		

*4 I_{FHL} represents forward current when output goes from high to low.

*5 I_{FLH} represents forward current when output goes from low to high.

*6 Hysteresis stands for I_{FLH} / I_{FHL} .

■ Recommended Operating Conditions

Parameter	Symbol	MIN.	TYP.	MAX.	Unit
Low level output current	I_{OL}	-	1.6	16	mA
High level output current	PC934/PC935	I_{OH}	-	- 400	μA
	PC930/PC931 PC932/PC933	V_{CC}	4.5	5.0	15.0
Supply voltage	PC934/PC935	4.5	5.0	5.5	V
Operating temperature	T_{opr}	0	25	70	$^{\circ}C$

Fig. 1 Test Circuit for t_{PHL} , t_{PLH} , t_r , t_f

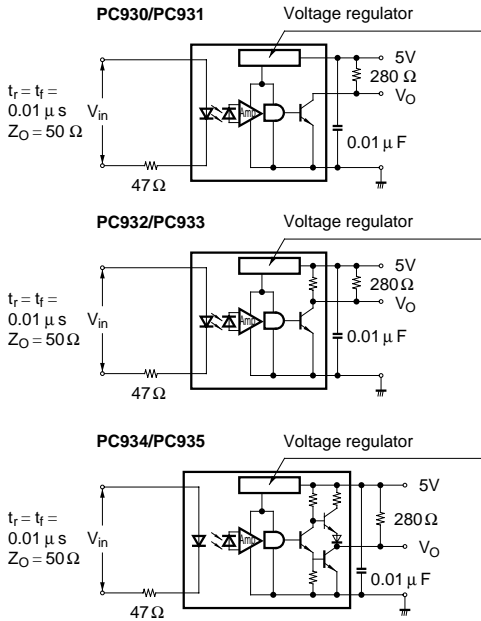

PC930/PC932/PC934

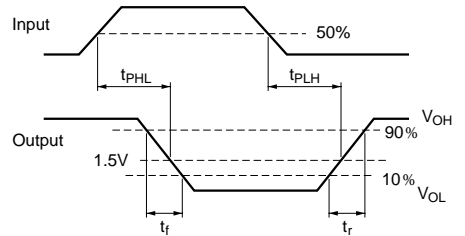

PC931/PC933/PC935

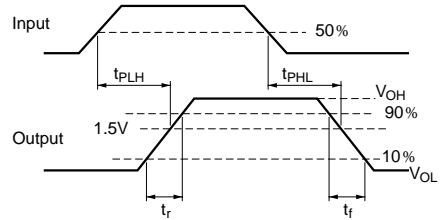

Fig. 2 Forward Current vs. Ambient Temperature

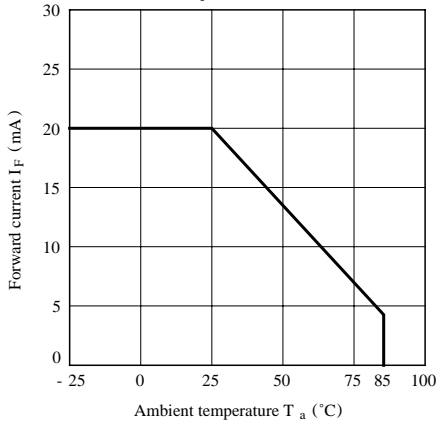

Fig. 3 Power Dissipation vs. Ambient Temperature

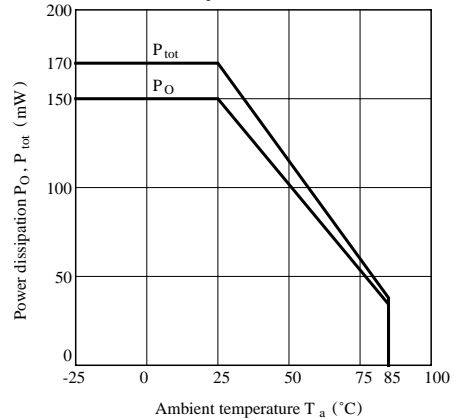

Fig. 4 Forward Current vs. Forward Voltage

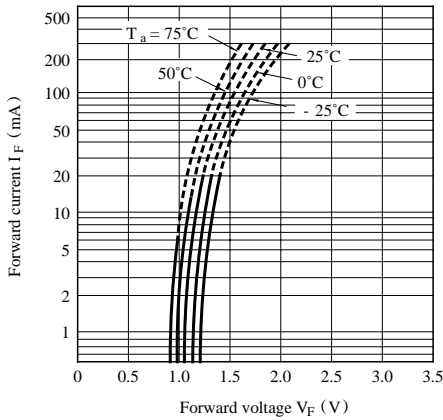

Fig. 5-a Relative Threshold Input Current vs. Supply Voltage

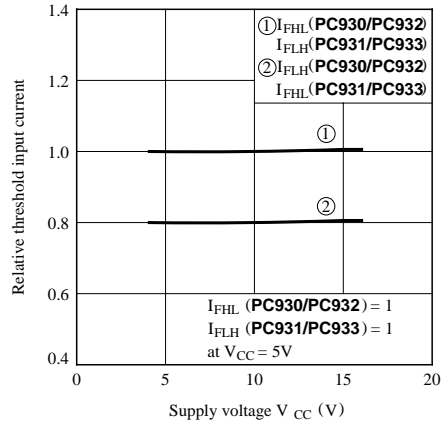

Fig. 5-b Relative Threshold Input Current vs. Supply Voltage

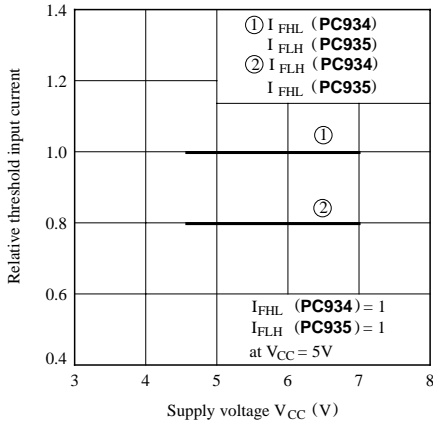

Fig. 6 Relative Threshold Input Current vs. Ambient Temperature

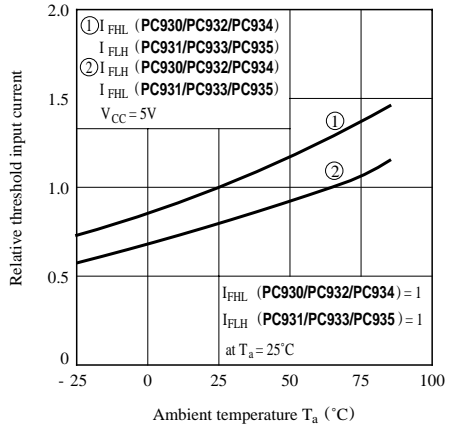

Fig. 7 Low Level Output Voltage vs. Low Level Output Current

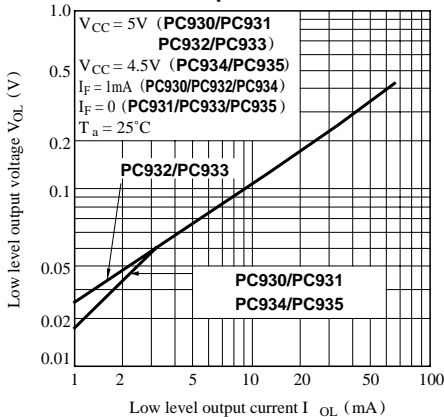

Fig. 8 Low Level Output Voltage vs. Ambient Temperature

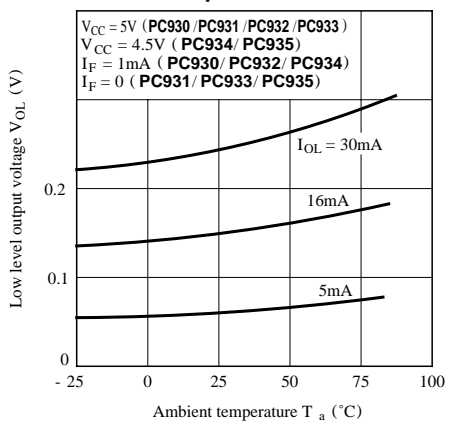

Fig. 9-a Supply Current vs. Supply Voltage (PC930/PC931)

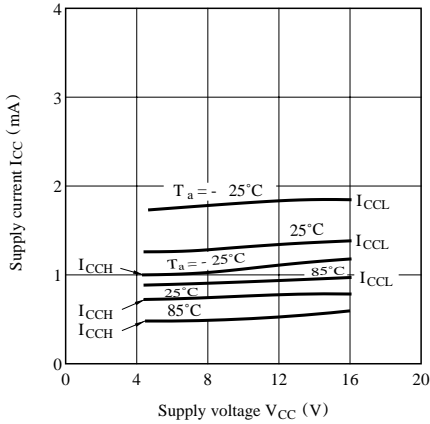

Fig. 9-b Supply Current vs. Supply Voltage (PC932/PC933)

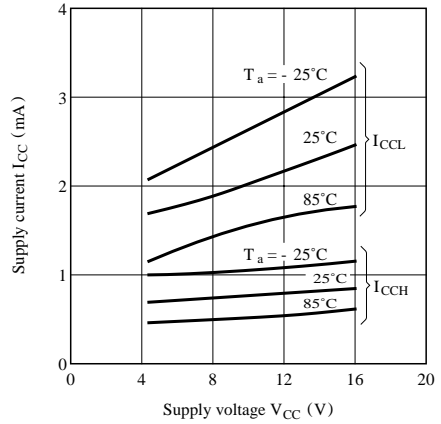

Fig. 9-c Supply Current vs. Supply Voltage (PC934/PC935)

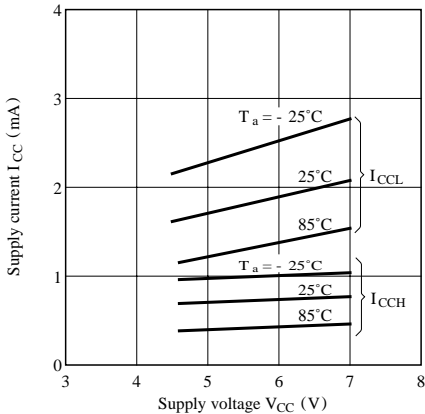

Fig.10 Propagation Delay Time vs. Forward Current

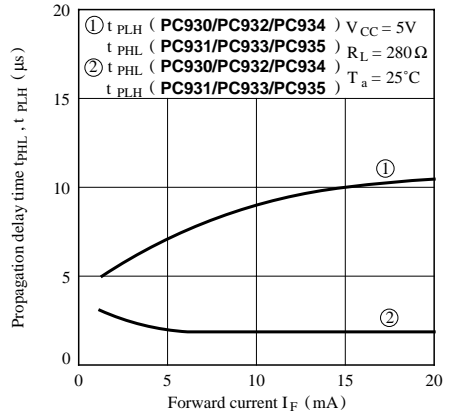

Fig.11-a Rise Time, Fall Time vs. Load Resistance (PC930/PC931)

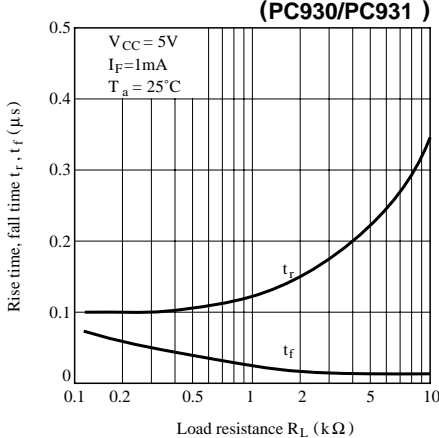

Fig.11-b Rise Time, Fall Time vs. Load Resistance (PC932/PC933)

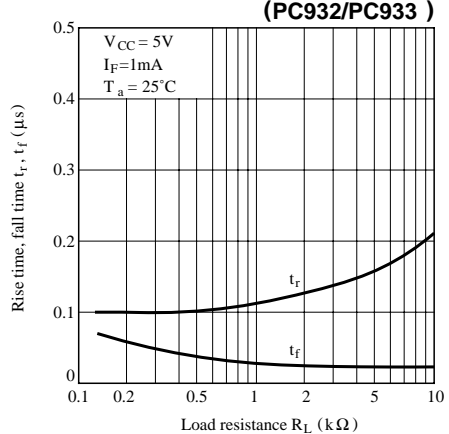
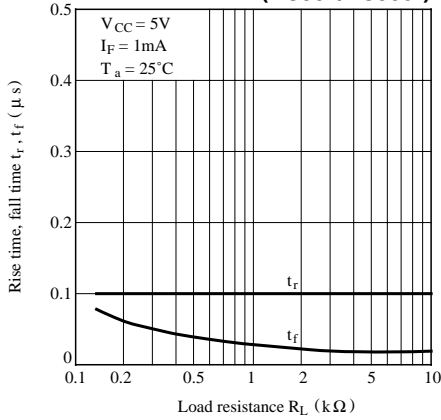

Fig.11-c Rise Time, Fall Time vs.
Resistance Load
(PC934/PC935)



■ Precautions for Use

- (1) It is recommended that a by-pass capacitor of more than $0.01 \mu F$ is added between V_{CC} and GND near the device in order to stabilize power supply line.
- (2) Handle this product the same as with other integrated circuits against static electricity.
- (3) As for other general cautions, refer to the chapter "Precautions for Use".