

FEATURES

- **Current Transfer Ratio at $I_F=10$ mA**
IL1, 20% Min.
IL2, 100% Min.
IL5, 50% Min.
- **High Collector-Emitter Voltage**
IL1 – $BV_{CEO}=50$ V
IL2, IL5 – $BV_{CEO}=70$ V
- **Field-Effect Stable by TRansparent IO n Shield (TRIOS)**
- **Double Molded Package Offers Isolation Test Voltage 5300 VAC_{RMS}**
- **Underwriters Lab File #E52744**
-  **VDE Approval #0884**
(Available with Option 1)

DESCRIPTION

The IL1/2/5 are optically coupled isolated pairs employing GaAs infrared LEDs and silicon NPN phototransistor. Signal information, including a DC level, can be transmitted by the drive while maintaining a high degree of electrical isolation between input and output. The IL1/2/5 are especially designed for driving medium-speed logic and can be used to eliminate troublesome ground loop and noise problems. These couplers can be used also to replace relays and transformers in many digital interface applications such as CRT modulation.

See Appnote 45, "How to Use Optocoupler Normalized Curves."

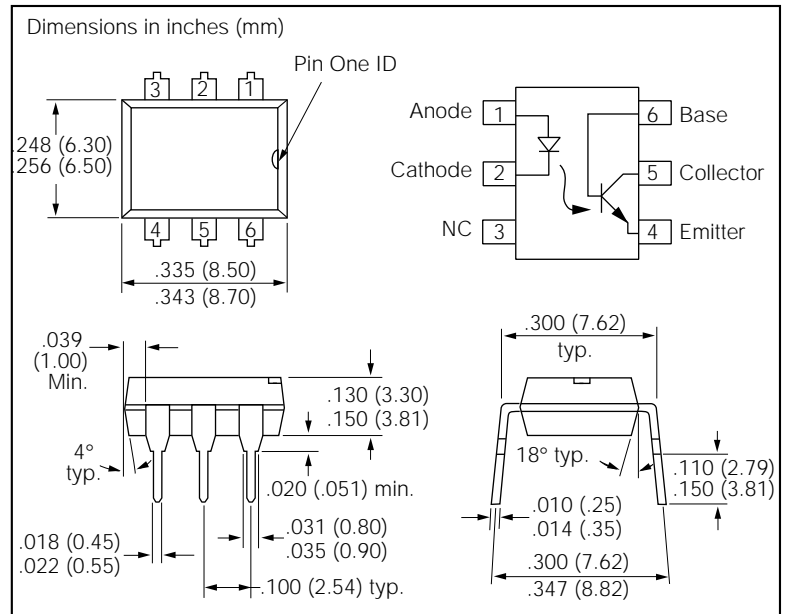

Maximum Ratings

Emitter

Reverse Voltage	6 V
Forward Current	60 mA
Surge Current	2.5 A
Power Dissipation	100 mW
Derate Linearly from 25°C	1.33 mW/°C

Detector

Collector-Emitter Reverse Voltage	
IL1	50 V
IL2, IL5	70 V
Emitter-Base Reverse Voltage	7 V
Collector-Base Reverse Voltage	70 V
Collector Current	50 mA
Collector Current ($t < 1$ ms)	400 mA
Power Dissipation	200 mW
Derate Linearly from 25°C	2.6 mW/°C

Package

Package Power Dissipation	250 mW
Derate Linearly from 25°C	3.3 mW/°C
Isolation Test Voltage (between emitter and detector referred to standard climate 23°C/50%RH, DIN 50014) 5300 VAC _{RMS}	
Creepage	min. 7 mm
Clearance	min. 7 mm
Comparative Tracking Index per DIN IEC 112/VDE 0303, part 1	175
Isolation Resistance	
$V_{IO}=500$ V, $T_A=25^\circ\text{C}$	$\geq 10^{12} \Omega$
$V_{IO}=500$ V, $T_A=100^\circ\text{C}$	$\geq 10^{11} \Omega$
Storage Temperature	-40°C to +150°C
Operating Temperature	-40°C to +100°C
Junction Temperature	100°C
Soldering Temperature (2 mm from case bottom)	260°C

Characteristics

	Symbol	Min	Typ	Max	Unit	Condition
Emitter						
Forward Voltage	V_F		1.25	1.65	V	$I_F=60\text{ mA}$
Breakdown Voltage	V_{BR}	6	30		V	$I_R=10\text{ }\mu\text{A}$
Reverse Current	I_R		0.01	10	μA	$V_R=6\text{ V}$
Capacitance	C_O		40		pF	$V_R=0\text{ V}$, $f=1\text{ MHz}$
Thermal Resistance Junction to Lead	R_{THJL}		750		$^{\circ}\text{C/W}$	
Detector						
Capacitance	C_{CE} C_{CB} C_{EB}		6.8 8.5 11		pF pF pF	$V_{CE}=5\text{ V}$, $f=1\text{ MHz}$ $V_{CB}=5\text{ V}$, $f=1\text{ MHz}$ $V_{EB}=5\text{ V}$, $f=1\text{ MHz}$
Collector-Emitter Leakage Current	I_{CEO}		5	50	nA	$V_{CE}=10\text{ V}$
Collector-Emitter Saturation Voltage	V_{CESAT}		0.25			$I_{CE}=1\text{ mA}$, $I_B=20\text{ }\mu\text{A}$
Base-Emitter Voltage	V_{BE}		0.65		V	$V_{CE}=10\text{ V}$, $I_B=20\text{ }\mu\text{A}$
DC Forward Current Gain	HFE	200	650	1800		$V_{CE}=10\text{ V}$, $I_B=20\text{ }\mu\text{A}$
Saturated DC Forward Current Gain	HFE_{SAT}	120	400	600		$V_{CE}=0.4\text{ V}$, $I_B=20\text{ }\mu\text{A}$
Thermal Resistance Junction to Lead	R_{THJL}		500		$^{\circ}\text{C/W}$	
Package Transfer Characteristics						
IL1						
Saturated Current Transfer Ratio (Collector-Emitter)	CTR_{CESAT}		75		%	$I_F=10\text{ mA}$, $V_{CE}=0.4\text{ V}$
Current Transfer Ratio (Collector-Emitter)	CTR_{CE}	20	80	300	%	$I_F=10\text{ mA}$, $V_{CE}=10\text{ V}$
Current Transfer Ratio (Collector-Base)	CTR_{CB}		0.25		%	$I_F=10\text{ mA}$, $V_{CB}=9.3\text{ V}$
IL2						
Saturated Current Transfer Ratio (Collector-Emitter)	CTR_{CESAT}		170		%	$I_F=10\text{ mA}$, $V_{CE}=0.4\text{ V}$
Current Transfer Ratio (Collector-Emitter)	CTR_{CE}	100	200	500	%	$I_F=10\text{ mA}$, $V_{CE}=10\text{ V}$
Current Transfer Ratio	CTR_{CB}		0.25		%	$I_F=10\text{ mA}$, $V_{CB}=9.3\text{ V}$
IL5						
Saturated Current Transfer Ratio (Collector-Emitter)	CTR_{CESAT}		100		%	$I_F=10\text{ mA}$, $V_{CE}=0.4\text{ V}$
Current Transfer Ratio (Collector-Emitter)	CTR_{CE}	50	130	400	%	$I_F=10\text{ mA}$, $V_{CE}=10\text{ V}$
Current Transfer Ratio	CTR_{CB}		0.25		%	$I_F=10\text{ mA}$, $V_{CB}=9.3\text{ V}$
Isolation and Insulation						
Common Mode Rejection Output High	CMH		5000		V/ μs	$V_{CM}=50\text{ V}_{P-P}$, $R_L=1\text{ k}\Omega$, $I_F=0\text{ mA}$
Common Mode Rejection Output Low	CML		5000		V/ μs	$V_{CM}=50\text{ V}_{P-P}$, $R_L=1\text{ k}\Omega$, $I_F=10\text{ mA}$
Common Mode Coupling Capacitance	C_{CM}		0.01		pF	
Package Capacitance	C_{I-O}		0.6		pF	$V_{I-O}=0\text{ V}$, $f=1\text{ MHz}$
Insulation Resistance	R_S		10^{+14}		Ω	$V_{I-O}=500\text{ V}$

SWITCHING TIMES

Figure 1. Non-saturated switching timing

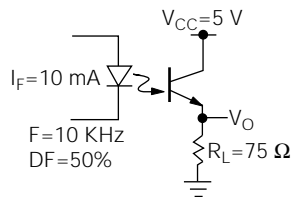

Figure 2. Saturated switching timing

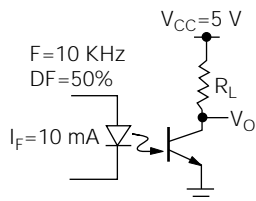

Figure 3. Non-saturated switching timing

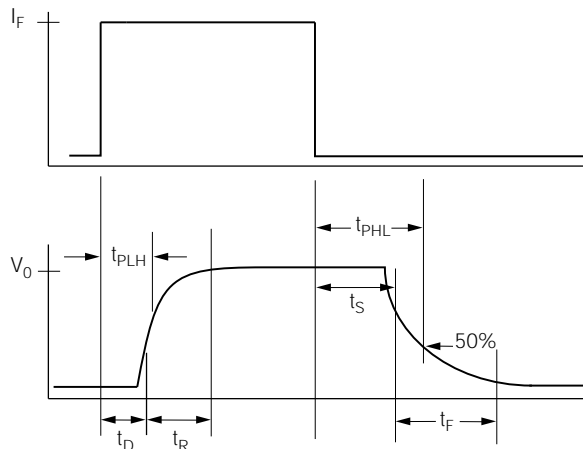
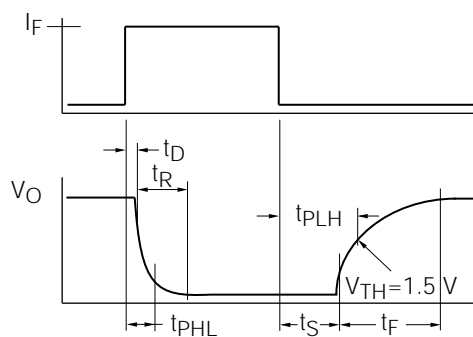

Figure 4. Saturated switching timing



Non-Saturated Switching Time Table-Typical

Characteristic	Sym	IL1 I _F =20 mA	IL2 I _F =5 mA	IL5 I _F =10 mA	Unit	Test Condition
Delay	T _D	0.8	1.7	1.7	μs	
Rise Time	t _R	1.9	2.6	2.6	μs	V _{CC} =5 V
Storage	t _S	0.2	0.4	0.4	μs	R _L =75 Ω
Fall Time	t _F	1.4	2.2	2.2	μs	
Propagation H-L	t _{PHL}	0.7	1.2	1.1	μs	t _p measured at 50% of output
Propagation L-H	t _{PLH}	1.4	2.3	2.5	μs	

Saturated Switching Time Table-Typical

Characteristic	Sym	IL1 I _F =20 mA	IL2 I _F =5 mA	IL5 I _F =10 mA	Unit	Test Condition
Delay	T _D	0.8	1	1.7	μs	
Rise Time	t _R	1.2	2	7	μs	V _{CL} =5.0 V
Storage	t _S	7.4	5.4	4.6	μs	V _{CE} =0.4
Fall Time	t _F	7.6	13.5	20	μs	R _L =1 K
Propagation H-L	t _{PHL}	1.6	5.4	2.6	μs	V _{TH} =1.5 V
Propagation L-H	t _{PLH}	8.6	7.4	7.2	μs	

Figure 5. Forward voltage versus forward current

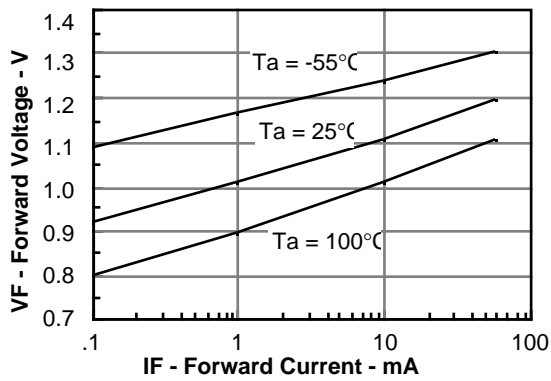

Figure 6. Normalized non-saturated and saturated CTR at $T_A=25^\circ\text{C}$ versus LED current

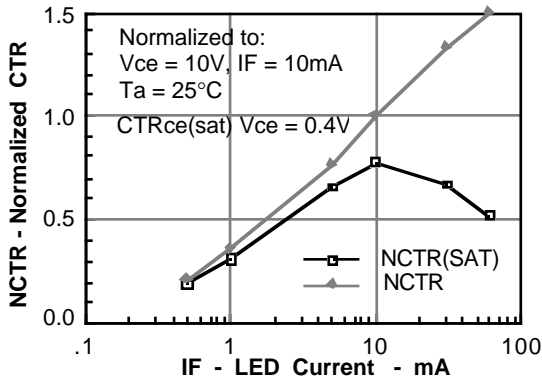

Figure 7. Normalized non-saturated and saturated CTR at $T_A=50^\circ\text{C}$ versus LED current

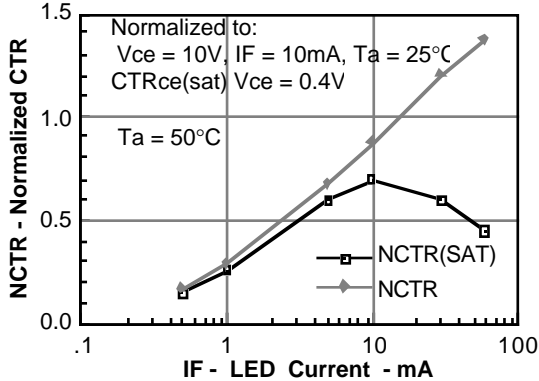

Figure 8. Normalized non-saturated and saturated CTR at $T_A=70^\circ\text{C}$ versus LED current

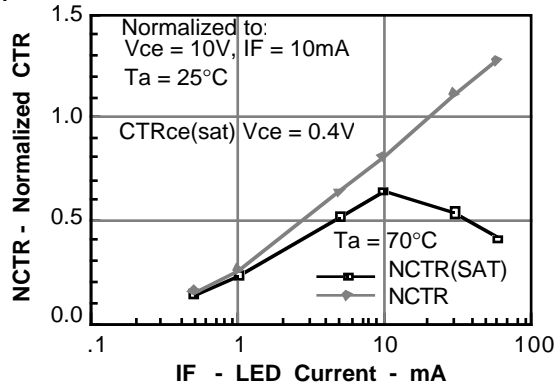

Figure 9. Normalized non-saturated and saturated CTR at $T_A=100^\circ\text{C}$ versus LED current

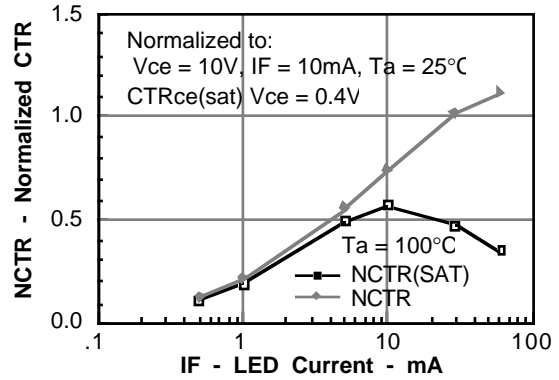

Figure 10. Collector-emitter current versus temperature and LED current

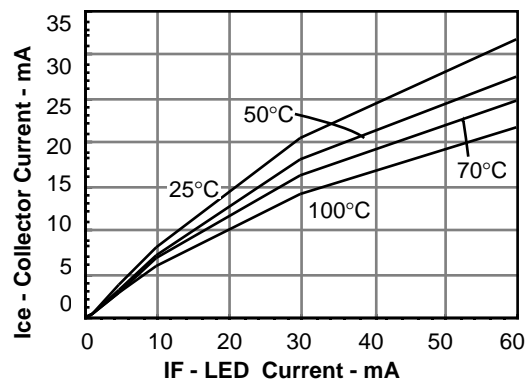

Figure 11. Collector-emitter leakage current versus temperature

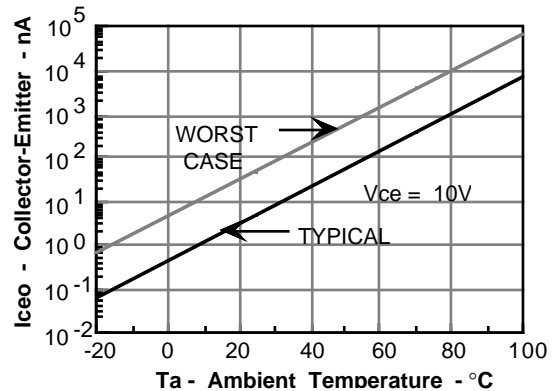

Figure 12. Normalized CTR_{cb} versus LED current and temperature

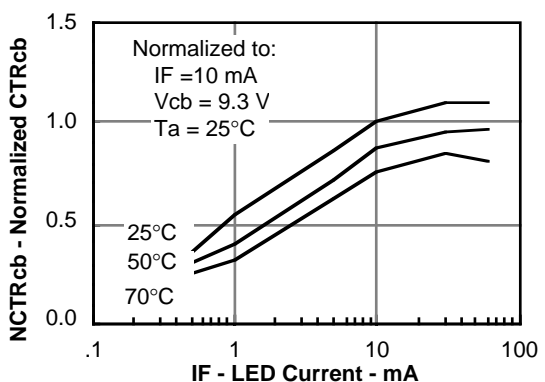

Figure 13. Collector base photocurrent versus LED current

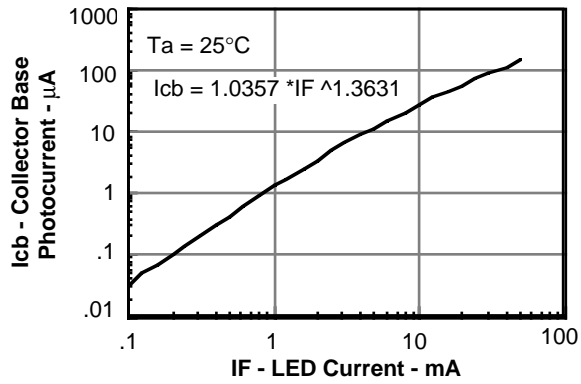

Figure 16. Normalized saturated HFE versus base current and temperature

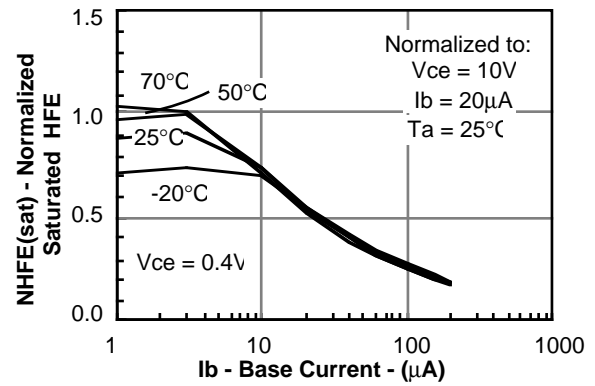

Figure 14. Normalized photocurrent versus I_f and temperature

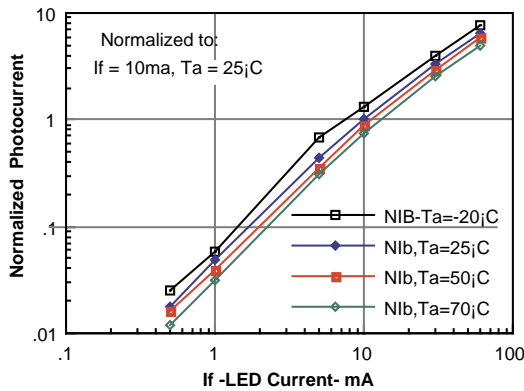

Figure 17. Propagation delay versus collector load resistor

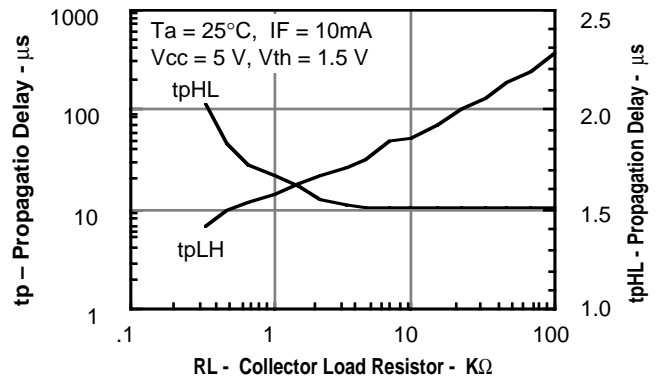

Table 15. Normalized non-saturated HFE versus base current and temperature

