



87D 09431 D

T-51-19

EF6840

PROGRAMMABLE TIMER MODULE (PTM)

The EF6840 is a programmable subsystem component of the 6800 family designed to provide variable system time intervals. The EF6840 has three 16-bit binary counters, three corresponding control registers and a status register. These counters are under software control and may be used to cause system interrupts and/or generate output signals. The EF6840 may be utilized for such tasks as frequency measurements, event counting, interval measuring and similar tasks. The device may be used for square wave generation, gated delay signals, single pulses of controlled duration, and pulse width modulation as well as system interrupts.

- Operates from a single 5 V power supply
- Fully TTL compatible
- Single system clock required (Enable)
- Selectable prescaler on timer 3 capable of 4 MHz for the EF6840, 6 MHz for the EF68A40 and 8 MHz for the EF68B40.
- Programmable interrupts (IRQ) output to MPU
- Readable down counter indicates counts to go to time-out,
- Selectable gating for frequency or pulse-width comparison
- RESET input
- Three asynchronous external clock and gate/trigger inputs internally synchronized
- Three maskable outputs
- Three available versions : EF6840 (1.0 MHz)
EF68A40 (1.5 MHz)
EF68B40 (2.0 MHz)

MOS

PROGRAMMABLE TIMER

(N-CHANNEL, SILICON-GATE DEPLETION LOAD)

CASES

CB-132

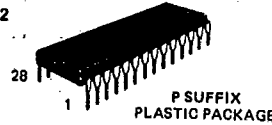

P SUFFIX PLASTIC PACKAGE

ALSO AVAILABLE

J SUFFIX CERDIP PACKAGE

C SUFFIX CERAMIC PACKAGE

CB-520

CB-707



FN SUFFIX PLCC 28



E SUFFIX LCCC 28

Hi-Rel versions available - See chapter 9

FIGURE 1 - PIN ASSIGNMENT

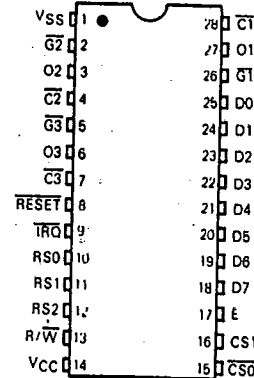

87D 09432 D T-51-19
FIGURE 2 - BLOCK DIAGRAM

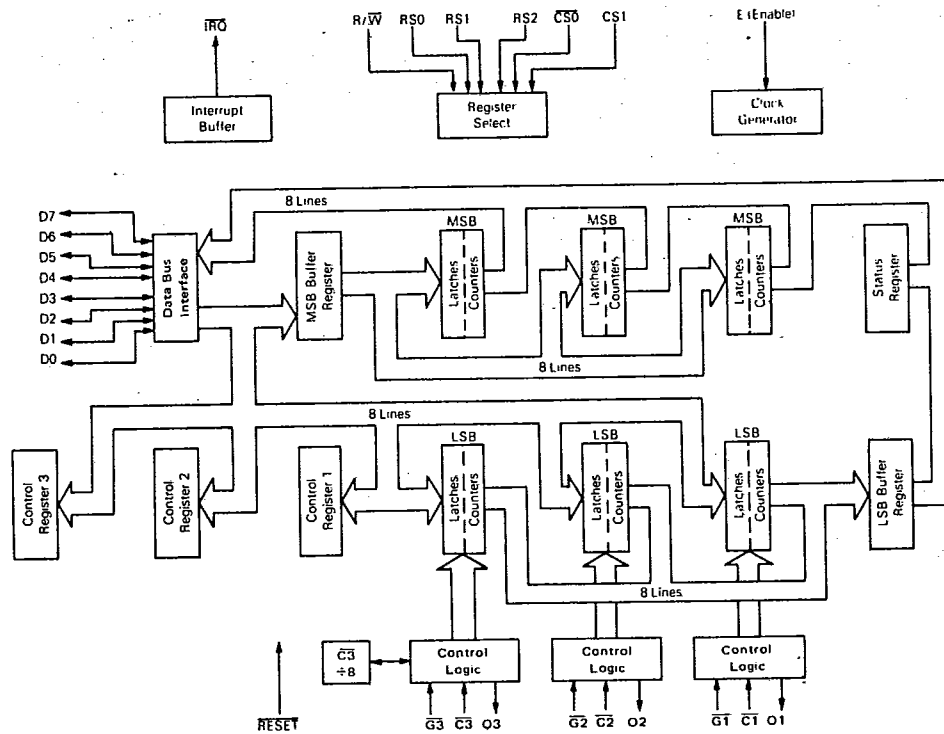

POWER CONSIDERATIONS

The average chip-junction temperature, T_J , in $^{\circ}\text{C}$ can be obtained from:

$$T_J = T_A + (P_D \cdot \theta_{JA}) \tag{1}$$

Where:

T_A = Ambient Temperature, $^{\circ}\text{C}$

θ_{JA} = Package Thermal Resistance, Junction-to-Ambient, $^{\circ}\text{C}/\text{W}$

$P_D = P_{INT} + P_{PORT}$

$P_{INT} = I_{CC} \times V_{CC}$, Watts - Chip Internal Power

P_{PORT} = Port Power Dissipation, Watts - User Determined

For most applications $P_{PORT} \ll P_{INT}$ and can be neglected. P_{PORT} may become significant if the device is configured to drive Darlington bases or sink LED loads.

An approximate relationship between P_D and T_J (if P_{PORT} is neglected) is:

$$P_D = K + (T_J + 273^{\circ}\text{C}) \tag{2}$$

Solving equations 1 and 2 for K gives:

$$K = P_D \cdot (T_A + 273^{\circ}\text{C}) + \theta_{JA} \cdot P_D^2 \tag{3}$$

Where K is a constant pertaining to the particular part. K can be determined from equation 3 by measuring P_D (at equilibrium) for a known T_A . Using this value of K the values of P_D and T_J can be obtained by solving equations (1) and (2) iteratively for any value of T_A .

87D 09433 DT-51-19

MAXIMUM RATINGS

Rating	Symbol	Value	Unit
Supply Voltage	V _{CC}	-0.3 to +7.0	V
Input Voltage	V _{in}	-0.3 to +7.0	V
Operating Temperature Range - T _L to T _H EF6840, EF68A40, EF68B40 EF6840, EF68A40, EF68B40 : V suffix EF6840, EF68A40 .M suffix	T _A	0 to +70 -40 to +85 -55 to +125	°C
Storage Temperature Range	T _{stg}	-65 to +150	°C

This device contains circuitry to protect the inputs against damage due to high static voltages or electric fields, however, it is advised that normal precautions be taken to avoid application of any voltage higher than maximum rated voltages to this high-impedance circuit. For proper operation it is recommended that V_{in} and V_{out} be constrained to the range V_{SS} ≤ (V_{in} or V_{out}) ≤ V_{CC}. Reliability of operation is enhanced if unused inputs are tied to an appropriate logic voltage level (e.g., either V_{SS} or V_{CC}).

THERMAL CHARACTERISTICS

Characteristic	Symbol	Value	Unit
Thermal Resistance			
CerDip	θ _{JA}	65	°C/W
Plastic		115	
Ceramic		60	
PLCC		100	

DC ELECTRICAL CHARACTERISTICS (V_{CC} = 5.0 Vdc ± 5%, V_{SS} = 0, T_A = T_L to T_H unless otherwise noted)

Characteristic	Symbol	Min	Typ	Max	Unit
Input High Voltage	V _{IH}	V _{SS} + 2.0	-	V _{CC}	V
Input Low Voltage	V _{IL}	V _{SS} - 0.3	-	V _{SS} + 0.8	V
Input Leakage Current (V _{in} = 0 to 5.25 V)	I _{in}	-	1.0	2.5	μA
Hi-Z (Off State) Input Current (V _{in} = 0.5 to 2.4 V)	I _{TSI}	-	2.0	10	μA
Output High Voltage (I _{Load} = -205 μA) (I _{Load} = -200 μA)	VOH	V _{SS} + 2.4 V _{SS} + 2.4	-	-	V
Output Low Voltage (I _{Load} = 1.6 mA) (I _{Load} = 3.2 mA)	VOL	-	-	V _{SS} + 0.4 V _{SS} + 0.4	V
Output Leakage Current (Off State) (V _{OH} = 2.4 V)	I _{LOH}	-	1.0	10	μA
Internal Power Dissipation (Measured at T _A = T _L)	P _{INT}	-	470	700	mW
Input Capacitance (V _{in} = 0, T _A = 25°C, f = 1.0 MHz)	C _{in}	-	-	12.5 7.5	pF
Output Capacitance (V _{in} = 0, T _A = 25°C, f = 1.0 MHz)	C _{out}	-	-	5.0 10	pF

AC OPERATING CHARACTERISTICS (See Figures 4-9)

Characteristic	Symbol	EF6840		EF68A40		EF68B40		Unit
		Min	Max	Min	Max	Min	Max	
Input Rise and Fall Times (Figures 4 and 5) \bar{C} , \bar{G} , and RESET	t _r , t _f	-	1.0*	-	0.666*	-	0.500*	μs
Input Pulse Width Low (Figure 4) (Asynchronous Input) \bar{C} , \bar{G} , and RESET	PWL	t _{cycE} + t _{su} + t _{hd}	-	t _{cycE} + t _{su} + t _{hd}	-	t _{cycE} + t _{su} + t _{hd}	-	ns
Input Pulse Width High (Figure 5) (Asynchronous Input) \bar{C} , \bar{G}	PWH	t _{cycE} + t _{su} + t _{hd}	-	t _{cycE} + t _{su} + t _{hd}	-	t _{cycE} + t _{su} + t _{hd}	-	ns
Input Setup Time (Figure 6) (Synchronous Input) \bar{C} , \bar{G} , and RESET	t _{su}	200	-	120	-	75	-	ns
Input Hold Time (Figure 6) (Synchronous Input) \bar{C} , \bar{G} , and RESET	t _{hd}	50	-	50	-	50	-	ns
Input Synchronization Time (Figure 9) \bar{C} 1 - 8 Prescaler Mode Only)	t _{sync}	250	-	200	-	175	-	ns
Input Pulse Width \bar{C} 1 - 8 Prescaler Mode Only)	PWL, PWH	120	-	80	-	60	-	ns
Output Delay, O1-O3 (Figure 7)								
(V _{OH} = 2.4 V, Load B)	TTL t _{co}	-	700	-	460	-	340	ns
(V _{OH} = 2.4 V, Load D)	MOS t _{cm}	-	450	-	450	-	340	ns
(V _{OH} = 0.7 V _{DD} , Load D)	CMOS t _{cmos}	-	2.0	-	1.35	-	1.0	μs
Interrupt Release Time	t _{IR}	-	1.2	-	0.9	-	0.7	μs

*t_r and t_f ≤ t_{cycE}

87D 09434 D T-51-19

BUS TIMING CHARACTERISTICS (See Notes 1, 2, and 3)

Ident. Number	Characteristic	Symbol	EF6840		EF68A40		EF68B40		Unit
			Min	Max	Min	Max	Min	Max	
1	Cycle Time	t_{cyc}	10	10	0.67	10	0.5	10	μs
2	Pulse Width, E Low	PWEL	430	9500	280	9500	210	9500	ns
3	Pulse Width, E High	PWEH	450	9500	280	9500	220	9500	ns
4	Clock Rise and Fall Time	$t_{r, f}$	-	25	-	25	-	20	ns
9	Address Hold Time	t _{AH}	10	-	10	-	10	-	ns
13	Address Setup Time Before E	t _{AS}	80	-	60	-	40	-	ns
14	Chip Select Setup Time Before E	t _{CS}	80	-	60	-	40	-	ns
15	Chip Select Hold Time	t _{CH}	10	-	10	-	10	-	ns
18	Read Data Hold Time	t _{DHR}	20	60*	20	50*	20	60*	ns
21	Write Data Hold Time	t _{DHW}	10	-	10	-	10	-	ns
30	Peripheral Output Data Delay Time	t _{DDR}	-	290	-	180	-	150	ns
31	Peripheral Input Data Setup Time	t _{DSW}	165	-	80	-	60	-	ns

*The data bus output buffers are no longer sourcing or sinking current by t_{DHR} max (High Impedance).

FIGURE 3 - BUS TIMING

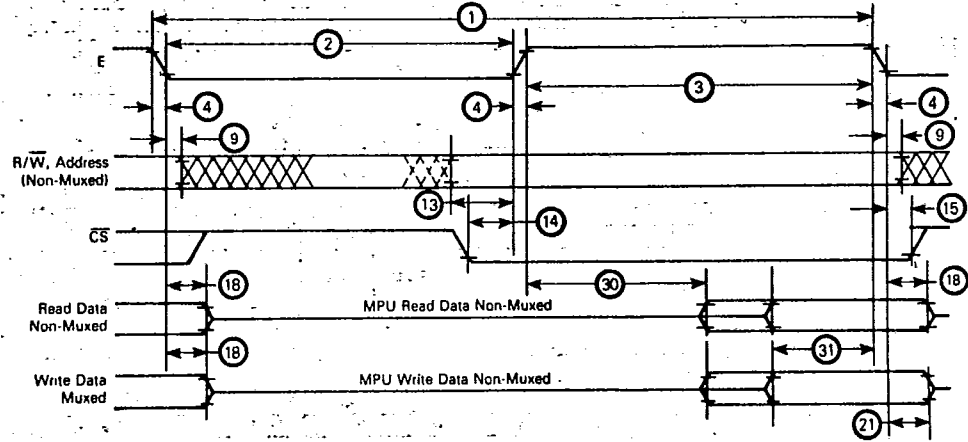

FIGURE 4 - INPUT PULSE WIDTH LOW

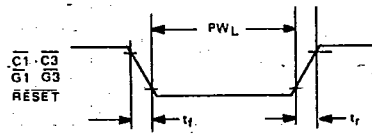
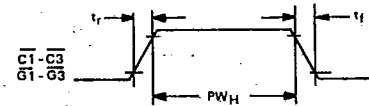

FIGURE 5 - INPUT PULSE WIDTH HIGH



NOTES

- Not all signals are applicable to every part.
- Voltage levels shown are $V_L \leq 0.4V$, $V_H \geq 2.4V$, unless otherwise specified.
- Measurement points shown are 0.8V and 2.0V, unless otherwise specified.

87D 09435

DT-51-19

FIGURE 6 - INPUT SETUP AND HOLD TIMES

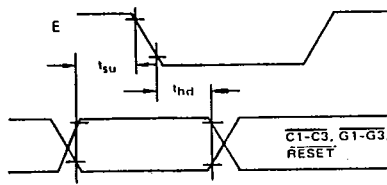

FIGURE 7 - OUTPUT DELAY

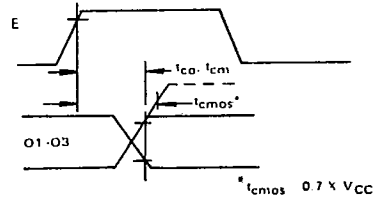

FIGURE 8 - \overline{IRQ} RELEASE TIME

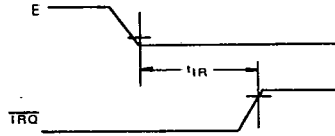

FIGURE 9 - $\overline{C3}$ INPUT SYNCHRONIZATION TIME (-8 PRESCALER MODE ONLY)

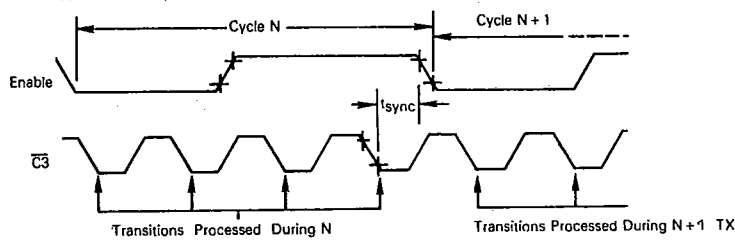
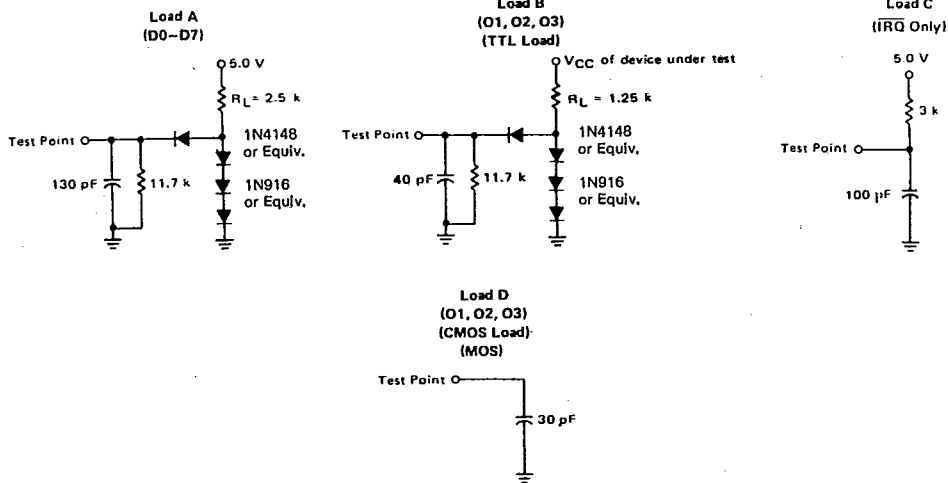

FIGURE 10 - BUS TIMING TEST LOADS



NOTE: Timing measurements are referenced to and from a low voltage of 0.8 volt and a high voltage of 2.0 volts, unless otherwise noted.

87D 09436 D T-51-19

DEVICE OPERATION

The EF6840 is part of the 6800 microprocessor family and is fully bus compatible with 6800 systems. The three timers in the EF6840 operate independently and in several distinct modes to fit a wide variety of measurement and synthesis applications.

The EF6840 is an integrated set of three distinct counter/timers (Figure 1). It consists of three 16-bit data latches, three 16-bit counters (clocked independently), and the comparison and enable circuitry necessary to implement various measurement and synthesis functions. In addition, it contains interrupt drivers to alert the processor that a particular function has been completed.

In a typical application, a timer will be loaded by first storing two bytes of data into an associated Counter Latch. This data is then transferred into the counter via a Counter Initialization cycle. If the counter is enabled, the counter decrements on each subsequent clock period which may be an external clock, or Enable (E) until one of several predetermined conditions causes it to halt or recycle. The timers are thus programmable, cyclic in nature, controllable by external inputs or the MPU program, and accessible by the MPU at any time.

BUS INTERFACE

The Programmable Timer Module (PTM) interfaces to the 6800 Bus with an 8-bit bidirectional data bus, two Chip Select lines, a Read/Write line, a clock (Enable) line, and Interrupt Request line, an external Reset line, and three Register select lines. VMA should be utilized in conjunction with an MPU address line into a Chip Select of the PTM when using the EF6800/6802/6808.

BIDIRECTIONAL DATA (D0-D7) — The bidirectional data lines (D0-D7) allow the transfer of data between the MPU and PTM. The data bus output drivers are three-state devices which remain in the high-impedance (off) state except when the MPU performs a PTM read operation (Read/Write and Enable lines high and PTM Chip Selects activated).

CHIP SELECT ($\overline{CS0}$, $CS1$) — These two signals are used to activate the Data Bus interface and allow transfer of data from the PTM. With $\overline{CS0}=0$ and $CS1=1$, the device is selected and data transfer will occur.

READ/WRITE (R/\overline{W}) — This signal is generated by the MPU to control the direction of data transfer on the Data Bus. With the PTM selected, a low state on the PTM R/\overline{W} line enables the input buffers and data is transferred from the MPU to the PTM on the trailing edge of the E (Enable) clock. Alternately, (under the same conditions) $R/\overline{W}=1$ and Enable high allows data in the PTM to be read by the MPU.

ENABLE (E CLOCK) — The E clock signal synchronizes data transfer between the MPU and the PTM. It also performs an equivalent synchronization function on the external clock, reset, and gate inputs of the PTM.

INTERRUPT REQUEST (\overline{IRQ}) — The active low Interrupt Request signal is normally tied directly (or through priority interrupt circuitry) to the \overline{IRQ} input of the MPU. This is an

"open drain" output (no load device on the chip) which permits other similar interrupt request lines to be tied together in a wire-OR configuration.

The \overline{IRQ} line is activated if, and only if, the Composite Interrupt Flag (Bit 7 of the Internal Status Register) is asserted. The conditions under which the \overline{IRQ} line is activated are discussed in conjunction with the Status Register.

RESET — A low level at this input is clocked into the PTM by the E (Enable) input. Two Enable pulses are required to synchronize and process the signal. The PTM then recognizes the active "low" or inactive "high" on the third Enable pulse. If the RESET signal is asynchronous, an additional Enable period is required if setup times are not met. The RESET input must be stable High/Low for the minimum time stated in the AC Operating Characteristics.

Recognition of a low level at this input by the PTM causes the following action to occur:

- a. All counter latches are preset to their maximum count values.
- b. All Control Register bits are cleared with the exception of CR10 (internal reset bit) which is set.
- c. All counters are preset to the contents of the latches.
- d. All counter outputs are reset and all counter clocks are disabled.
- e. All Status Register bits (interrupt flags) are cleared.

REGISTER SELECT LINES (RS0, RS1, RS2) — These inputs are used in conjunction with the R/\overline{W} line to select the internal registers, counters and latches as shown in Table 1.

NOTE:

The PTM is accessed via MPU Load and Store operations in much the same manner as a memory device. The instructions available with the 6800 family of MPUs which perform read-modify-write operations on memory should not be used when the PTM is accessed. These instructions actually fetch a byte from memory, perform an operation, then restore it to the same address location. Since the PTM uses the R/\overline{W} line as an additional register select input, the modified data will not be restored to the same register if these instructions are used.

CONTROL REGISTER

Each timer in the EF6840 has a corresponding write-only Control Register. Control Register #2 has a unique address space ($RS0=1$, $RS=0$, $RS2=0$) and therefore may be written into at any time. The remaining Control Registers (#1 and #3) share the Address Space selected by a logic zero on all Register Select inputs.

CR20 — The least-significant bit of Control Register #2 (CR20) is used as an additional addressing bit for Control Registers #1 and #3. Thus, with all Register selects and R/\overline{W} inputs at logic zero, Control Register #1 will be written into if CR20 is a logic one. Under the same conditions, Control Register #3 can also be written into after a RESET low condition has occurred, since all control register bits (except CR10) are cleared. Therefore, one may write in the sequence CR3, CR2, CR1.

87D 09437 D T-51-19

TABLE 1 - REGISTER SELECTION

Register Select Inputs			Operations	
RS2	RS1	RS0	R/W = 0	R/W = 1
0	0	0	CR20 = 0 Write Control Register #3 CR20 = 1 Write Control Register #1	No Operation
0	0	1	Write Control Register #2	Read Status Register
0	1	0	Write MSB Buffer Register	Read Timer #1 Counter
0	1	1	Write Timer #1 Latches	Read LSB Buffer Register
1	0	0	Write MSB Buffer Register	Read Timer #2 Counter
1	0	1	Write Timer #2 Latches	Read LSB Buffer Register
1	1	0	Write MSB Buffer Register	Read Timer #3 Counter
1	1	1	Write Timer #3 Latches	Read LSB Buffer Register

CR10 - The least significant bit of Control Register #1 is used as an Internal Reset bit. When this bit is a logic zero, all timers are allowed to operate in the modes prescribed by the remaining bits of the control registers. Writing a "one" into CR10 causes all counters to be preset with the contents of the corresponding counter latches, all counter clocks to be disabled, and the timer outputs and interrupt flags (Status Register) to be reset. Counter Latches and Control Registers are undisturbed by an Internal Reset and may be written into regardless of the state of CR10.

The least significant bit of Control Register #3 is used as a selector for a +8 prescaler which is available with Timer #3 only. The prescaler, if selected, is effectively placed between

the clock input circuitry and the input to Counter #3. It can therefore be used with either the internal clock (Enable) or an external clock source.

NOTE

When initializing Timer 3 into the divide-by-eight mode on consecutive E-cycles (i.e., with DMA), Control Register 3 must be initialized after Timer Latch #3 to insure proper timer initialization.

CR30 - The functions depicted in the foregoing discussions are tabulated in Table 2 for ease of reference.

TABLE 2 - CONTROL REGISTER BITS

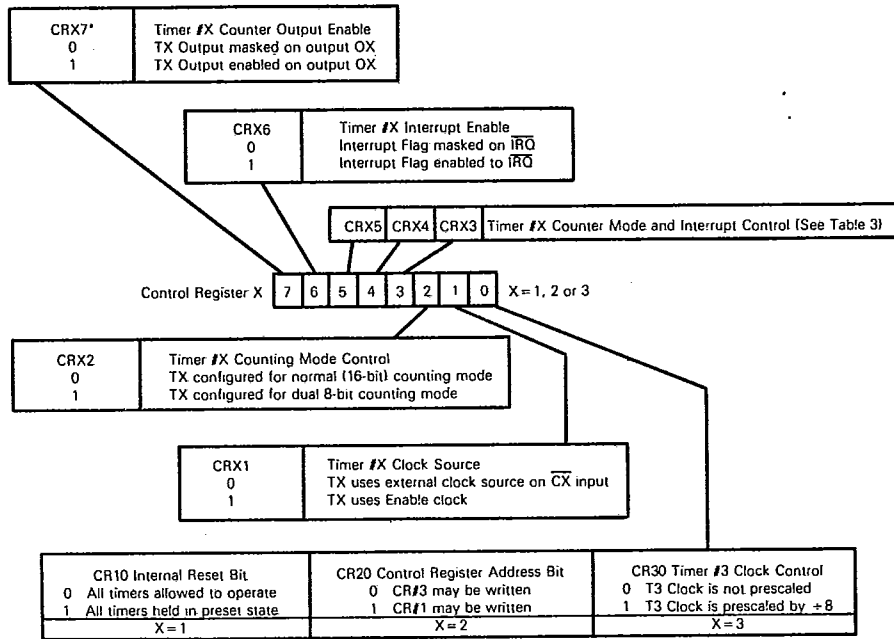

87D 09438 DT-51-19

Control Register Bits CR10, CR20, and CR30 are unique in that each selects a different function. The remaining bits (1 through 7) of each Control Register select common functions, with a particular Control Register affecting only its corresponding timer.

CRX1 — Bit 1 of Control Register #1 (CR11) selects whether an internal or external clock source is to be used with Timer #1. Similarly, CR21 selects the clock source for Timer #2, and CR31 performs this function for Timer #3. The function of each bit of Control Register "X" can therefore be defined as shown in the remaining section of Table 2.

CRX2 — Control Register Bit 2 selects whether the binary information contained in the Counter Latches (and subsequently loaded into the counter) is to be treated as a single 16-bit word or two 8-bit bytes. In the single 16-bit Counter Mode (CRX2=0) the counter will decrement to zero after N+1 enabled (G=0) clock periods, where N is defined as the 16-bit number in the Counter Latches. With CRX2=1, a similar Time Out will occur after (L+1)•(M+1) enabled clock periods, where L and M, respectively, refer to the LSB and MSB bytes in the Counter Latches.

CRX3-CRX7 — Control Register Bits 3, 4, and 5 are explained in detail in the Timer Operating Mode section. Bit 6 is an interrupt mask bit which will be explained more fully in conjunction with the Status Register, and bit 7 is used to enable the corresponding Timer Output. A summary of the control register programming modes is shown in Table 3.

STATUS REGISTER/INTERRUPT FLAGS

The EF6840 has an internal Read-Only Status Register which contains four Interrupt Flags. (The remaining four bits of the register are not used, and defaults to zeros when being read.) Bits 0, 1, and 2 are assigned to Timers 1, 2, and 3, respectively, as individual flag bits, while Bit 7 is a Composite Interrupt Flag. This flag bit will be asserted if any of the individual flag bits is set while Bit 6 of the corresponding Control Register is at a logic one. The conditions for asserting the composite Interrupt Flag bit can therefore be expressed as:

$$INT = I1 \cdot CR16 + I2 \cdot CR26 + I3 \cdot CR36$$

where INT = Composite Interrupt Flag (Bit 7)
 I1 = Timer #1 Interrupt Flag (Bit 0)
 I2 = Timer #2 Interrupt Flag (Bit 1)
 I3 = Timer #3 Interrupt Flag (Bit 2)

An interrupt flag is cleared by a Timer Reset condition, i.e., External RESET=0 or Internal Reset Bit (CR10)=1. It will also be cleared by a Read Timer Counter Command provided that the Status Register has previously been read while the interrupt flag was set. This condition on the Read Status Register-Read Timer Counter (RS-RT) sequence is designed to prevent missing interrupts which might occur after the status register is read, but prior to reading the Timer Counter.

An Individual Interrupt Flag is also cleared by a Write Timer Latches (W) command or a Counter Initialization (CI) sequence, provided that W or CI affects the Timer corresponding to the individual Interrupt Flag.

COUNTER LATCH INITIALIZATION





Each of the three independent timers consists of a 16-bit addressable counter and a 16-bit addressable latch. The counters are preset to the binary numbers stored in the latches. Counter initialization results in the transfer of the latch contents to the counter. See notes in Table 4 regarding the binary number N, L, or M placed into the Latches and their relationship to the output waveforms and counter Time-Outs.

Since the PTM data bus is 8-bits wide and the counters are 16-bits wide, a temporary register (MSB Buffer Register) is provided. This "write only" register is for the Most-Significant Byte of the desired latch data. Three addresses are provided for the MSB Buffer Register (as indicated in Table 1), but they all lead to the same Buffer. Data from the MSB Buffer will automatically be transferred into the Most-Significant Byte of Timer #X when a Write Timer #X Latches Command is performed. So it can be seen that the EF6840 has been designed to allow transfer of two bytes of data into the counter latches provided that the MSB is transferred first. The storage order must be observed to ensure proper latch operation.

In many applications, the source of the data will be a 6800 Family MPU. It should be noted that the 16-bit store operations of the 6800 family microprocessors (STS and STX) transfer data in the order required by the PTM. A Store Index Register Instruction, for example, results in the MSB of the X register being transferred to the selected address, then the LSB of the X register being written into the next higher location. Thus, either the index register or stack pointer may be transferred directly into a selected counter latch with a single instruction.

A logic zero at the RESET input also initializes the counter latches. In this case, all latches will assume a maximum count of 65,535₁₀. It is important to note that an Internal

TABLE 3 — PTM OPERATING MODE SELECTION

CRX3	CRX4	CRX5	
0	0	0	Continuous Operating Mode: Gate 1 or Write to Latches or Reset Causes Counter Initialization
1	0	0	Frequency Comparison Mode: Interrupt If Gate  is < Counter Time Out
0	1	0	Continuous Operating Mode: Gate 1 or Reset Causes Counter Initialization
1	1	0	Pulse Width Comparison Mode: Interrupt if Gate  is < Counter Time Out
0	0	1	Single Shot Mode: Gate 1 or Write to Latches or Reset Causes Counter Initialization
1	0	1	Frequency Comparison Mode: Interrupt If Gate  is > Counter Time Out
0	1	1	Single Shot Mode: Gate 1 or Reset Causes Counter Initialization
1	1	1	Pulse Width Comparison Mode: Interrupt If Gate  is > Counter Time Out

87D 09439 D T-51-19

Reset (Bit zero of Control Register 1 Set) has no effect on the counter latches.

COUNTER INITIALIZATION

Counter Initialization is defined as the transfer of data from the latches to the counter with subsequent clearing of the Individual Interrupt Flag associated with the counter. Counter Initialization always occurs when a reset condition (RESET=0 or CR10=1) is recognized. It can also occur — depending on Timer Mode — with a Write Timer Latches command or recognition of a negative transition of the Gate input.

Counter recycling or re-initialization occurs when a negative transition of the clock input is recognized after the counter has reached an all-zero state. In this case, data is transferred from the Latches to the Counter.

ASYNCHRONOUS INPUT/OUTPUT LINES

Each of the three timers within the PTM has external clock and gate inputs as well as a counter output line. The inputs are high-impedance, TTL-compatible lines and outputs are capable of driving two standard TTL loads.

CLOCK INPUTS (C1, C2, and C3) — Input pins C1, C2, and C3 will accept asynchronous TTL voltage level signals to decrement Timers 1, 2, and 3, respectively. The high and low levels of the external clocks must each be stable for at least one system clock period plus the sum of the setup and hold times for the clock inputs. The asynchronous clock rate can vary from dc to the limit imposed by the Enable Clock Setup, and Hold times.

The external clock inputs are clocked in by Enable pulses. Three Enable periods are used to synchronize and process the external clock. The fourth Enable pulse decrements the internal counter. This does not affect the input frequency, it merely creates a delay between a clock-input transition and internal recognition of that transition by the PTM. All references to C inputs in this document relate to internal recognition of the input transition. Note that a clock high or low level which does not meet setup and hold time specifications may require an additional Enable pulse for recognition. When observing recurring events, a lack of synchronization will result in "jitter" being observed on the output of the PTM when using asynchronous clocks and gate input signals. There are two types of jitter. "System jitter" is the result of the input signals being out of synchronization with Enable, permitting signals with marginal setup and hold time to be recognized by either the bit time nearest the input transition or the subsequent bit time.

"Input jitter" can be as great as the time between input signal negative going transitions plus the system jitter, if the first transition is recognized during one system cycle, and not recognized the next cycle, or vice versa. See Figure 11.

FIGURE 11 — INPUT JITTER

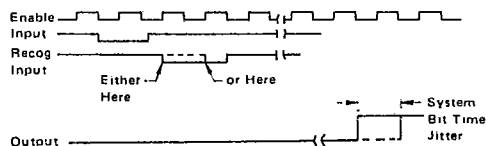

CLOCK INPUT C3 (-8 PRESCALER MODE) — External clock input C3 represents a special case when Timer #3 is programmed to utilize its optional -8 prescaler mode.

The divide-by-8 prescaler contains an asynchronous ripple counter; thus, input setup (t_{SU}) and hold times (t_{HD}) do not apply. As long as minimum input pulse widths are maintained, the counter will recognize and process all input clock (C3) transitions. However, in order to guarantee that a clock transition is processed during the current E cycle, a certain amount of synchronization time (t_{SYNC}) is required between the C3 transition and the falling edge of Enable (see Figure 9). If the synchronization time requirement is not met, it is possible that the C3 transition will not be processed until the following E cycle.

The maximum input frequency and allowable duty cycles for the -8 prescaler mode are specified under the AC Operating Characteristics. Internally, the -8 prescaler output is treated in the same manner as the previously discussed clock inputs.

GATE INPUTS (G1, G2, G3) — Input pins G1, G2, and G3 accept asynchronous TTL-compatible signals which are used as triggers or clock gating functions to Timers 1, 2, and 3, respectively. The gating inputs are clocked into the PTM by the E (enable) clock in the same manner as the previously discussed clock inputs. That is, a Gate transition is recognized by the PTM on the fourth Enable pulse (provided setup and hold time requirements are met), and the high or low levels of the Gate input must be stable for at least one system clock period plus the sum of setup and hold times. All references to G transition in this document relate to internal recognition of the input transition.

The Gate inputs of all timers directly affect the internal 16-bit counter. The operation of G3 is therefore independent of the -8 prescaler selection.

TIMER OUTPUTS (O1, O2, O3) — Timer outputs O1, O2, and O3 are capable of driving up to two TTL loads and produce a defined output waveform for either Continuous or Single-Shot Timer modes. Output waveform definition is accomplished by selecting either Single 16-bit or Dual 8 bit operating modes. The Single 16-bit mode will produce a square-wave output in the continuous mode and a single pulse in the single-shot mode. The Dual 8-bit mode will produce a variable duty cycle pulse in both the continuous and single-shot timer modes. One bit of each Control Register (CRX7) is used to enable the corresponding output. If this bit is cleared, the output will remain low (V_{OL}) regardless of the operating mode. If it is cleared while the output is high the output will go low during the first enable cycle following a write to the Control Register.

The Continuous and Single-Shot Timer Modes are the only ones for which output response is defined in this data sheet. Refer to the Programmable Timer Fundamentals and Applications manual for a discussion of the output signals in other modes. Signals appear at the outputs (unless CRX7=0) during Frequency and Pulse Width comparison modes, but the actual waveform is not predictable in typical applications.

TIMER OPERATING MODES T-51-19

The EF6840 has been designed to operate effectively in a wide variety of applications. This is accomplished by using three bits of each control register (CRX3, CRX4, and CRX5) to define different operating modes of the Timers. These modes are divided into WAVE SYNTHESIS and WAVE MEASUREMENT modes, and are outlined in Table 4.

TABLE 4 — OPERATING MODES

Control Register			Timer Operating Mode	
CRX3	CRX4	CRX5		
0	*	0	Continuous	Synthesizer
0	*	1	Single-Shot	
1	0	*	Frequency Comparison	Measurement
1	1	*	Pulse Width Comparison	

*Defines Additional Timer Function Selection.

One of the WAVE SYNTHESIS modes is the Continuous Operating mode, which is useful for cyclic wave generation. Either symmetrical or variable duty-cycle waves can be generated in this mode. The other wave synthesis mode, the Single-Shot mode, is similar in use to the Continuous operating mode, however, a single pulse is generated, with a programmable preset width.

The WAVE MEASUREMENT modes include the Frequency Comparison and Pulse Width Comparison modes which are used to measure cyclic and singular pulse widths, respectively.

In addition to the four timer modes in Table 4, the remaining control register bit is used to modify counter initialization and enabling or interrupt conditions.

WAVE SYNTHESIS MODES

CONTINUOUS OPERATING MODE (TABLE 5) — The continuous mode will synthesize a continuous wave with a period proportional to the preset number in the particular timer latches. Any of the timers in the PTM may be programmed to operate in a continuous mode by writing zeroes into bits 3 and 5 of the corresponding control register. Assuming

that the timer output is enabled (CRX7 = 1), either a square wave or a variable duty cycle waveform will be generated at the Timer Output, OX. The type of output is selected via Control Register Bit 2.

Either a Timer Reset (CR10 = 1 or External Reset = 0) condition or internal recognition of a negative transition of the Gate input results in Counter Initialization. A Write Timer latches command can be selected as a Counter Initialization signal by clearing CRX4.

The counter is enabled by an absence of a Timer Reset condition and a logic zero at the Gate input. In the 16-bit mode, the counter will decrement on the first clock cycle during or after the counter initialization cycle. It continues to decrement on each clock signal so long as G remains low and no reset condition exists. A Counter Time Out (the first clock after all counter bits = 0) results in the Individual Interrupt Flag being set and reinitialization of the counter.

In the Dual 8-bit mode (CRX2 = 1) [refer to the example in Figure 10 and Tables 5 and 6] the MSB decrements once for every full countdown of the LSB + 1. When the LSB = 0, the MSB is unchanged; on the next clock pulse the LSB is reset to the count in the LSB Latches, and the MSB is decremented by 1 (one). The output, if enabled, remains low during and after initialization and will remain low until the counter MSB is all zeroes. The output will go high at the beginning of the next clock pulse. The output remains high until both the LSB and MSB of the counter are all zeroes. At the beginning of the next clock pulse the defined Time Out (TO) will occur and the output will go low. In the Dual 8-bit mode the period of the output of the example in Figure 12 would span 20 clock pulses as opposed to 1546 clock pulses using the normal 16-bit mode.

A special time-out condition exists for the dual 8-bit mode (CRX2 = 1) if L = 0. In this case, the counter will revert to a mode similar to the single 16-bit mode, except Time Out occurs after $M + 1^*$ clock pulses. The output, if enabled, goes low during the Counter Initialization cycle and reverses state at each Time Out. The counter remains cyclical (is reinitialized at each Time Out) and the Individual Interrupt Flag is set when Time Out occurs. If $M = L = 0$, the internal counters do not change, but the output toggles at a rate of $\frac{1}{2}$ the clock frequency.

TABLE 5 — CONTINUOUS OPERATING MODES

Synthesis Modes		CONTINUOUS MODE (CRX3 = 0, CRX5 = 0)	
Control Register		Initialization/Output Waveforms	
CRX2	CRX4	Counter Initialization	*Timer Output (OX) (CRX7 = 1)
0	0	$\bar{G}_1 + W + R$	
0	1	$\bar{G}_1 + R$	
1	0	$\bar{G}_1 + W + R$	
1	1	$\bar{G}_1 + R$	

87D 09441 D T-51-19
 FIGURE 12 - TIMER OUTPUT WAVEFORM EXAMPLE
 (Continuous Dual 8-Bit Mode Using Internal Enable)

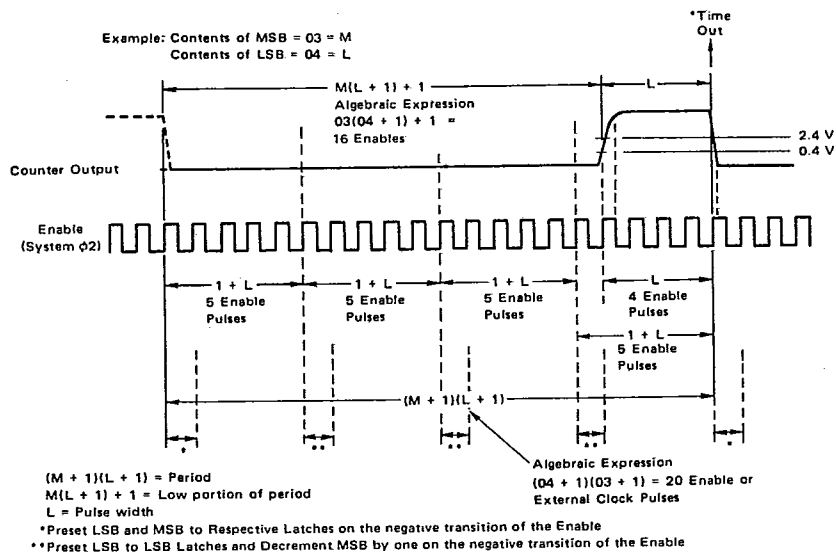

The discussion of the Continuous Mode has assumed that the application requires an output signal. It should be noted that the Timer operates in the same manner with the output disabled (CRX7=0). A Read Timer Counter command is valid regardless of the state of CRX7.

SINGLE-SHOT TIMER MODE - This mode is identical to the Continuous Mode with three exceptions. The first of these is obvious from the name - the output returns to a low level after the initial Time Out and remains low until another Counter Initialization cycle occurs.

As indicated in Table 6, the internal counting mechanism remains cyclical in the Single-Shot Mode. Each Time Out of

the counter results in the setting of an Individual Interrupt Flag and re-initialization of the counter.

The second major difference between the Single-Shot and Continuous modes is that the internal counter enable is not dependent on the Gate input level remaining in the low state for the Single-Shot mode.

Another special condition is introduced in the Single-Shot mode. If $L = M = 0$ (Dual 8-bit) or $N = 0$ (Single 16-bit), the output goes low on the first clock received during or after Counter Initialization. The output remains low until the Operating Mode is changed or nonzero data is written into the Counter Latches. Time Outs continue to occur at the end of each clock period.

TABLE 6 - SINGLE-SHOT OPERATING MODES

Synthesis Modes		SINGLE-SHOT MODE (CRX3 = 0, CRX7 = 1, CRX5 = 1)	
Control Register		Initialization/Output Waveforms	
CRX2	CRX4	Counter Initialization	Timer Output (OX)
0	0	$\bar{G}_i + W + R$	
0	1	$\bar{G}_i + R$	
1	0	$\bar{G}_i + W + R$	
1	1	$\bar{G}_i + R$	

Symbols are as defined in Table 5.

87D 09442 D T-51-19

The three differences between Single-Shot and Continuous Timer Mode can be summarized as attributes of the Single-Shot mode:

1. Output is enabled for only one pulse until it is reinitialized.
2. Counter Enable is independent of Gate.
3. L = M = 0 or N = 0 disables output.

Aside from these differences, the two modes are identical.

WAVE MEASUREMENT MODES

TIME INTERVAL MODES — The Time Interval Modes are the Frequency (period) Measurement and Pulse Width Comparison Modes, and are provided for those applications which require more flexibility of interrupt generation and Counter Initialization. Individual Interrupt Flags are set in these modes as a function of both Counter Time Out and transitions of the Gate input. Counter Initialization is also affected by Interrupt Flag status.

A timer's output is normally not used in a Wave Measurement mode, but it is defined. If the output is enabled, it will operate as follows. During the period between reinitialization of the timer and the first Time Out, the output will be a logical zero. If the first Time Out is completed (regardless of its method of generation), the output will go high. If further TO's occur, the output will change state at each completion of a Time-Out.

The counter does operate in either Single 16-bit or Dual 8-bit modes as programmed by CRX2. Other features of the Wave Measurement Modes are outlined in Table 7.

Frequency Comparison Or Period Measurement Mode (CRX3 = 1, CRX4 = 0) — The Frequency Comparison Mode with CRX5 = 1 is straightforward. If Time Out occurs prior to the first negative transition of the Gate input after a Counter Initialization cycle, an Individual Interrupt Flag is set. The counter is disabled, and a Counter Initialization cycle cannot begin until the interrupt flag is cleared and a negative transition on \bar{G} is detected.

If CRX5 = 0, as shown in Tables 7 and 8, an interrupt is generated if Gate input returns low prior to a Time Out. If a Counter Time Out occurs first, the counter is recycled and continues to decrement. A bit is set within the timer on the initial Time Out which precludes further individual interrupt

generation until a new Counter Initialization cycle has been completed. When this internal bit is set, a negative transition of the Gate input starts a new Counter Initialization cycle. (The condition of $\bar{G} \cdot \bar{T} \cdot \bar{O}$ is satisfied, since a Time Out has occurred and no individual Interrupt has been generated.)

Any of the timers within the PTM may be programmed to compare the period of a pulse (giving the frequency after calculations) at the Gate input with the time period requested for Counter Time Out. A negative transition of the Gate input enables the counter and starts a Counter Initialization cycle — provided that other conditions, as noted in Table 8, are satisfied. The counter decrements on each clock signal recognized during or after Counter Initialization until an interrupt is generated, a Write Timer Latches command is issued, or a Timer Reset condition occurs. It can be seen from Table 8 that an interrupt condition will be generated if CRX5 = 0 and the period of the pulse (single pulse or measured separately repetitive pulses) at the Gate input is less than the Counter Time Out period. If CRX5 = 1, an interrupt is generated if the reverse is true.

Assume now with CRX5 = 1 that a Counter Initialization has occurred and that the Gate input has returned low prior to Counter Time Out. Since there is no Individual Interrupt Flag generated, this automatically starts a new Counter Initialization Cycle. The process will continue with frequency comparison being performed on each Gate input cycle until the mode is changed, or a cycle is determined to be above the predetermined limit.

Pulse Width Comparison Mode (CRX3 = 1, CRX4 = 1) — This mode is similar to the Frequency Comparison Mode except for a positive, rather than negative, transition of the Gate input terminates the count. With CRX5 = 0, an Individual Interrupt Flag will be generated if the zero level pulse applied to the Gate input is less than the time period required for Counter Time Out. With CRX5 = 1, the interrupt is generated when the reverse condition is true:

As can be seen in Table 8, a positive transition of the Gate input disables the counter. With CRX5 = 0, it is therefore possible to directly obtain the width of any pulse causing an interrupt. Similar data for other Time Interval Modes and conditions can be obtained, if two sections of the PTM are dedicated to the purpose.

FIGURE 7 — OUTPUT DELAY

CRX3 = 1			
CRX4	CRX5	Application	Condition for Setting Individual Interrupt Flag
0	0	Frequency Comparison	Interrupt Generated if Gate Input Period (1/F) is less than Counter Time Out (TO)
0	1	Frequency Comparison	Interrupt Generated if Gate Input Period (1/F) is greater than Counter Time Out (TO)
1	0	Pulse Width Comparison	Interrupt Generated if Gate Input "Down Time" is less than Counter Time Out (TO)
1	1	Pulse Width Comparison	Interrupt Generated if Gate Input "Down Time" is greater than Counter Time Out (TO)

87D 09443
TABLE 8 - FREQUENCY COMPARISON MODE

DT-51-19

Mode	Bit 3	Bit 4	Control Reg. Bit 5	Counter Initialization	Counter Enable Flip-Flop Set (CE)	Counter Enable Flip-Flop Reset (CE)	Interrupt Flag Set (I)
Frequency Comparison	1	0	0	$\overline{GI} \cdot \overline{I} \cdot \overline{CE} \cdot \overline{TO} \cdot R$	$\overline{GI} \cdot \overline{W} \cdot \overline{R} \cdot \overline{I}$	$W \cdot R \cdot I$	\overline{GI} Before \overline{TO}
Pulse Width Comparison	1	0	1	$\overline{GI} \cdot \overline{I} \cdot R$	$\overline{GI} \cdot \overline{W} \cdot \overline{R} \cdot \overline{I}$	$W \cdot R \cdot I$	\overline{TO} Before \overline{GI}
	1	1	0	$\overline{GI} \cdot \overline{I} \cdot \overline{R}$	$\overline{GI} \cdot \overline{W} \cdot \overline{R} \cdot \overline{I}$	$W \cdot R \cdot I \cdot G$	\overline{GI} Before \overline{TO}
	1	1	1	$\overline{GI} \cdot \overline{I} \cdot R$	$\overline{GI} \cdot \overline{W} \cdot \overline{R} \cdot \overline{I}$	$W \cdot R \cdot I \cdot G$	\overline{GI} Before \overline{TO}

\overline{GI} = Negative transition of Gate input.
 W = Write Timer Latches Command.
 R = Timer Reset (CR10 = 1 or External RESET = 0)
 N = 16-Bit Number in Counter Latch.
 TO = Counter Time Out (All Zero Condition)
 I = Interrupt for a given timer.

*All time intervals shown above assume the Gate (\overline{GI}) and Clock (\overline{CI}) signals are synchronized to the system clock (E) with the specified setup and hold time requirements

ORDERING INFORMATION

EF68A40		C	M	B/B	Screening level							
Device		Package		Oper. temp.								
The table below horizontally shows all available suffix combinations for package, operating temperature and screening level. Other possibilities on request.												
DEVICE	PACKAGE					OPER. TEMP			SCREENING LEVEL			
	C	J	P	E	FN	L*	V	M	Std	D	G/B	B/B
EF6840 (1.0 MHz)	•	•	•		•	•			•			
	•	•	•				•		•		•	•
	•	•						•	•		•	
EF68A40 (1.5 MHz)	•	•	•			•			•			
	•	•	•				•		•		•	•
	•	•			•			•	•		•	
EF68B40 (2.0 MHz)	•	•	•			•			•			
	•	•					•		•		•	
Examples : EF6840C, EF6840CV, EF6840CM, EF6840JM												
Package : C : Ceramic DIL, J : Cerdip DIL, P : Plastic DIL, E : LCCC, FN : PLCC.												
Oper. temp. : L* : 0°C to +70°C, V : -40°C to +85°C, M : -55°C to +125°C, * : may be omitted.												
Screening level : Std : (no-end suffix), D : NFC 96883 level D,												
G/B : NFC 96883 level G, B/B : NFC 96883 level B and MIL-STD-883C level B.												

PHYSICAL DIMENSIONS

87D 09444

DT-51-19

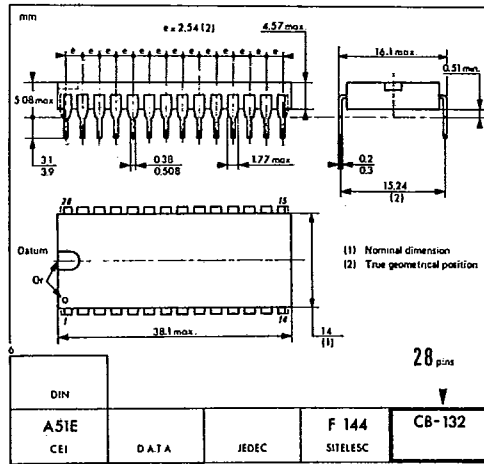

CB-132

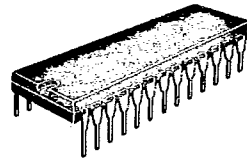

P SUFFIX
PLASTIC PACKAGE

ALSO AVAILABLE

J SUFFIX CERDIP PACKAGE C SUFFIX CERAMIC PACKAGE

87D 09445 D T-51-19

CB-520



FN SUFFIX
PLCC 28

CB-707



E SUFFIX
LCCC 28

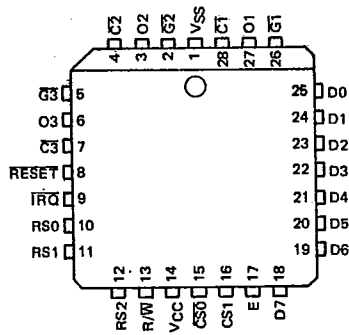
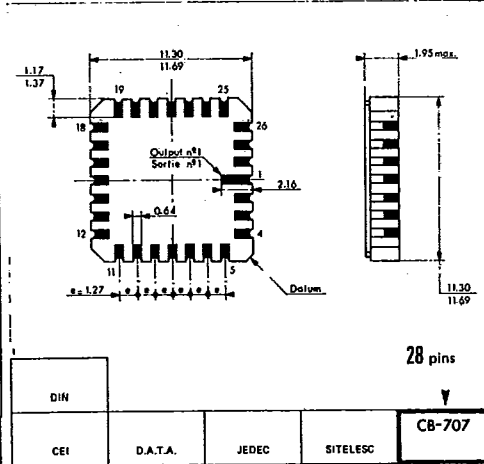
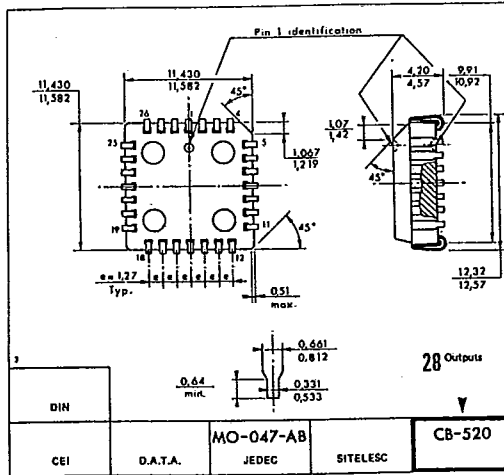

Copyright © Each Manufacturing Company.

All Datasheets cannot be modified without permission.

This datasheet has been download from :

www.AllDataSheet.com

100% Free DataSheet Search Site.

Free Download.

No Register.

Fast Search System.

www.AllDataSheet.com