

## Data Sheet

Customer:

Product: Thick Film Chip Resistor - CR Series

Size: 01005/0201/0402/0603/0805/1206/1210/2010/2512

Issued Date: 1-Dec-22

Edition: REV.A5



VIKING TECH CORPORATION  
光頡科技股份有限公司

No.70 Guangfu N. Rd., Hukou  
Township, Hsinchu County 303,  
Taiwan

TEL:886-3-5972931

FAX:886-3-5972935•886-3-5973494

E-mail:sales@viking.com.tw

VIKING TECH CORPORATION KAOHSIUNG BRANCH  
光頡科技股份有限公司高雄分公司

No.248-3, Sin-Sheng Rd., Cian-Jhen Dist., Kaohsiung,  
806, Taiwan

TEL:886-7-8217999

FAX:886-7-8228229

E-mail:sales@viking.com.tw

VIKING ELECTRONICS (WUXI) CO., LTD.  
光頡電子(無錫)有限公司

No.22 Xixia Road, Machinery & Industry Park,  
National Hi-Tech Industrial Development Zone  
of Wuxi, Wuxi, Jiangsu Province, China  
Zip Code:214028

TEL:86-510-85203339

FAX:86-510-85203667•86-510-85203977

E-mail:china@viking.com.tw

Produced by (QC)	Checked (QC)	Approved by (QC)	Prepared by (Sales)	Accepted by (Customer)
1-Dec-22	1-Dec-22	1-Dec-22	1-Dec-22	
<b>Mandy Chen</b>	<b>Ben Chang</b>	<b>Ben Chang</b>		

**Thick Film Chip Resistor**  
**Thick Film Chip Resistor**



**■ Features**

- Small size and light weight
- Highly reliable multilayer electrode construction
- Compatible with all soldering process
- Long side terminations

**■ Construction**

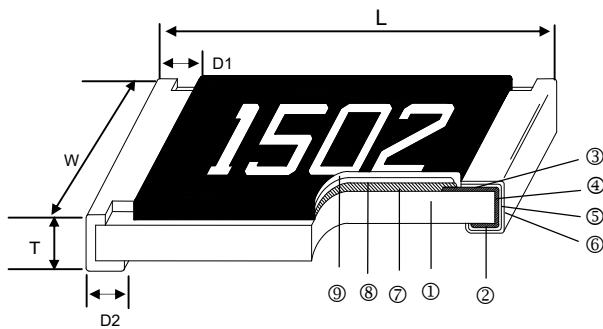

**■ Applications**

- Telecommunication Equipments
- Radio and Tape Recorders, TV Tuners
- Digital Cameras, Watches, Pocket Calculators
- Computers, Instruments
- Medical Equipment

① Alumina Substrate	④ Edge Electrode	⑦ Resistor Layer
② Bottom Electrode	⑤ Barrier Layer	⑧ Primary Overcoat
③ Top Electrode	⑥ External Electrode	⑨ Secondary Overcoat

**■ Dimensions**

Type	Size (Inch)	L (mm)	W (mm)	T (mm)	D1 (mm)	D2 (mm)	Weight (g) (1000pcs)
CR-E5	01005	0.40±0.02	0.20±0.02	0.13±0.03	0.10±0.03	0.10±0.03	0.037
CR-01	0201	0.60±0.03	0.30±0.03	0.23±0.03	0.15±0.05	0.15±0.05	0.150
CR-02	0402	1.00±0.05	0.50±0.05	0.30±0.05	0.20±0.10	0.25±0.10	0.620
CR-03	0603	1.60±0.10	0.80±0.10	0.45±0.10	0.30±0.20	0.30±0.20	2.042
CR-05	0805	2.00±0.10	1.25±0.15	0.50±0.10	0.30±0.20	0.40±0.20	4.368
CR-06	1206	3.20±0.20	1.60±0.15	0.55±0.10	0.50±0.20	0.50±0.20	8.947
CR-10	1210	3.20±0.20	2.50±0.20	0.55±0.10	0.50±0.20	0.50±0.20	15.959
CR-0A	2010	5.00±0.20	2.50±0.20	0.55±0.10	0.60±0.20	0.60±0.20	24.241
CR-12	2512	6.30±0.20	3.20±0.20	0.55±0.10	0.60±0.20	0.60±0.20	39.448

**Thick Film Chip Resistor**

**Part Numbering**

Part Number : CR-03FL7---10R

Part Number : CR-03JL7----0R

CR-	03	F	L	7	- - - 1 0 R
CR-	03	J	L	7	- - - - 0 R
Product Type	Dimensions	Resistance Tolerance	Function Code	Packaging Code	Resistance
CR-	E5: 01005 01: 0201 02: 0402 03: 0603 05: 0805 06: 1206 10: 1210 0A: 2010 12: 2512	F: ±1% J: ±5%	L: Standard	0: 7" Reel 15Kpcs 4: 7" Reel 4Kpcs 5: 7" Reel 20Kpcs 6: 7" Reel 10Kpcs 7: 7" Reel 5Kpcs	--- 1R2: 1.2Ω --- 3K3: 3.3KΩ --- 10K: 10KΩ -- 100K: 100KΩ “-“ to fill up 6 spaces

**Standard Electrical Specifications**

Item Type	Power Rating at 70°C Jumper Rated Current	Operating Temp. Range	Max. Operating Voltage	Max. Overload Voltage	Max. Overload Current of Jumper	Resistance Range		TCR (PPM/°C)
						±1%(E24、E96)	±5%(E24)	
CR-E5 (01005)	1/32W	-55 ~ +125°C	15V	30V	-	1Ω - 9.76Ω 10Ω - 97.6Ω 100Ω - 1MΩ		±400 ±250 ±200
	Jumper: 0.5A		-	-	1A	-	0Ω (≤50mΩ)	-
CR-01 (0201)	1/20W	-55 ~ +155°C	25V	50V	-	1Ω - 9.76Ω 10Ω - 10MΩ		±300 ±200
	Jumper: 0.5A		-	-	1A	-	0Ω (≤50mΩ)	-
CR-02 (0402)	1/16W	-55 ~ +155°C	50V	100V	-	1Ω - 9.76Ω 10Ω - 10MΩ		±200 ±100
	Jumper: 1A		-	-	2A	-	0Ω (≤50mΩ)	-
CR-03 (0603)	1/10W	-55 ~ +155°C	75V	150V	-	1Ω - 9.76Ω 10Ω - 10MΩ		±200 ±100
	Jumper: 1A		-	-	3A	-	0Ω (≤50mΩ)	-
CR-05 (0805)	1/8W	-55 ~ +155°C	150V	300V	-	1Ω - 9.76Ω 10Ω - 10MΩ		±200 ±100
	Jumper: 2A		-	-	5A	-	0Ω (≤50mΩ)	-
CR-06 (1206)	1/4W	-55 ~ +155°C	200V	400V	-	1Ω - 9.76Ω 10Ω - 10MΩ		±200 ±100
	Jumper: 2A		-	-	5A	-	0Ω (≤50mΩ)	-
CR-10 (1210)	1/3W	-55 ~ +155°C	200V	400V	-	1Ω - 9.76Ω 10Ω - 10MΩ		±200 ±100
	Jumper: 2A		-	-	5A	-	0Ω (≤50mΩ)	-
CR-0A (2010)	3/4W	-55 ~ +155°C	200V	400V	-	1Ω - 9.76Ω 10Ω - 10MΩ		±200 ±100
	Jumper: 2A		-	-	5A	-	0Ω (≤50mΩ)	-
CR-12 (2512)	1W	-55 ~ +155°C	200V	500V	-	1Ω - 9.76Ω 10Ω - 10MΩ		±200 ±100
	Jumper: 2A		-	-	5A	-	0Ω (≤50mΩ)	-

Rated Voltage=√(P\*R) or Max. Operating Voltage listed above, whichever is lower.  
Current of DC or AC RMS value

**Derating Curve**

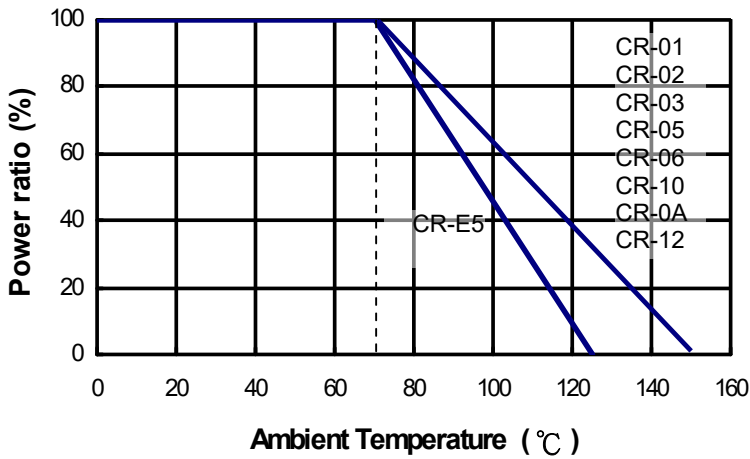

**Soldering Condition**

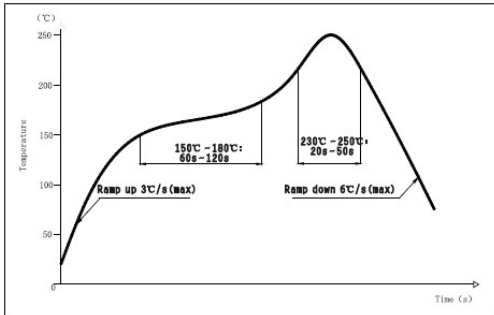

IR Reflow Soldering

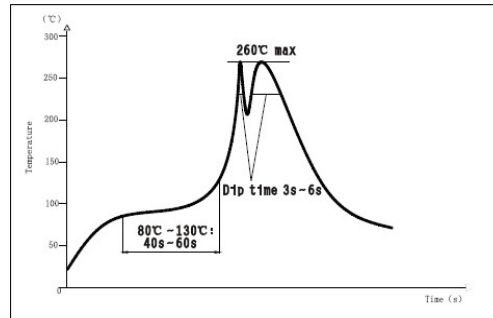

Wave Soldering (Flow Soldering)

**Recommend Solder Pad Size**

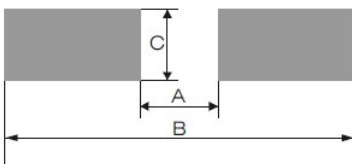

Type	A (mm)	B (mm)	C (mm)
CR-E5	0.17±0.03	0.60±0.03	0.22±0.03
CR-01	0.23±0.05	0.84±0.05	0.38±0.05
CR-02	0.45±0.05	1.45±0.05	0.60±0.05
CR-03	0.80±0.05	2.50±0.05	0.95±0.05
CR-05	1.05±0.1	3.25±0.1	1.40±0.1
CR-06	1.90±0.1	4.50±0.1	1.75±0.1
CR-10	2.00±0.1	4.60±0.1	2.70±0.1
CR-0A	3.50±0.1	6.50±0.1	2.70±0.1
CR-12	4.80±0.1	7.80±0.1	3.40±0.1

**Environmental Characteristics**

Item	Requirement			Test Method
	±1%	±5%	Jumper	
Temperature Coefficient of Resistance (T.C.R.)	As Spec.			<b>IEC-60115-1 4.8</b> +20°C / -55°C/+20°C/+125°C/+20°C
Short Time Overload	01005 size: ±(2.0%+0.05Ω)		≤50mΩ	<b>IEC-60115-1 4.13</b> Rated voltage*2.5 or Max. Overload Voltage whichever is lower for 5 seconds Jumper: Max. overload current for 5 seconds
	Other sizes: ±(1.0%+0.05Ω)	Other sizes: ±(2.0%+0.05Ω)		
Insulation Resistance	>1000MΩ			<b>IEC-60115-1 4.6</b> Apply DC100V±15V between substrate and terminations for 1 minute, then check insulation resistance
Endurance	01005 size: ±(3.0%+0.05Ω)		≤100mΩ	<b>IEC-60115-1 4.25.1</b> 70±2°C, rated voltage or operating voltage whichever is lower (Jumper : Rated current) for 1000 hrs with 1.5 hrs "ON" and 0.5 hr "OFF"
	Other sizes: ±(1.0%+0.05Ω)	Other sizes: ±(2.0%+0.05Ω)		
Damp Heat with Load	01005 size: ±(3.0%+0.05Ω)		≤100mΩ	<b>IEC-60115-1 4.24</b> 40±2°C, 93±3% R.H., rated voltage or operating voltage whichever is lower (Jumper : Rated current) for 1000 hrs with 1.5 hrs "ON" and 0.5 hr "OFF"
	Other sizes: ±(1.0%+0.05Ω)	Other sizes: ±(2.0%+0.05Ω)		
Endurance at Upper Category Temperature	01005 size: ±(3.0%+0.05Ω)		≤100mΩ	<b>IEC-60115-1 4.25.3</b> 01005 size: at +125±2°C for 1000 hrs Other sizes: at +155±2°C for 1000 hrs
	Other sizes: ±(1.0%+0.05Ω)	Other sizes: ±(2.0%+0.05Ω)		
Bending Strength	±(1.0%+0.05Ω)	±(1.0%+0.05Ω)	≤50mΩ	<b>IEC-60115-1 4.33</b> Bending once for 60±5 seconds 01005 size: 3mm ; 0201, 0402, 0603, 0805 sizes: 5mm 1206, 1210 sizes: 4mm ; 2010, 2512 sizes: 2mm
Solderability	95% min. coverage			<b>IEC-60115-1 4.17</b> 245±5°C for 3±0.3 seconds
Resistance to Soldering Heat	±(1.0%+0.05Ω)	±(1.0%+0.05Ω)	≤50mΩ	<b>IEC-60115-1 4.18</b> 270±5°C for 10±1 seconds
Voltage Proof	No breakdown or flashover			<b>IEC-60115-1 4.7</b> Apply max. overload of AC RMS at a rated of approximately 100V/s between substrate and terminations for 60±5 seconds
Shear Test	No mechanical damage			<b>IEC-60115-1 4.32</b> Applying force: 0201 size: 2N ; 0402, 0603 sizes: 5N 0805 size: 9N , 1206, 1210 sizes: 25N 2010, 2512 sizes: 45N Duration: 10±1 seconds
Rapid Change of Temperature	01005 size: ±(1.0%+0.05Ω)		≤50mΩ	<b>IEC-60115-1 4.19</b> 01005 size: -55°C to +125°C, 300 cycles Other sizes: -55°C to +155°C, 300 cycles
	Other sizes: ±(0.5%+0.05Ω)	Other sizes: ±(1.0%+0.05Ω)		
Operation at Low Temperature	01005 size: ±(2.0%+0.05Ω)		≤50mΩ	<b>IEC-60115-1 4.36</b> -55±5°C, 1hr without load, rated voltage or operating voltage whichever is lower (Jumper: Rated current) for 45minute, 15minute without load
	Other sizes: ±(1.0%+0.05Ω)	Other sizes: ±(2.0%+0.05Ω)		
Component Solvent Resistance	±(1.0%+0.05Ω)	±(1.0%+0.05Ω)	≤50mΩ	<b>IEC-60115-1 4.29</b> Iso-propyl alcohol (IPA), 23±5°C, 10hrs

**Storage Temperature: 5~30°C; Humidity: 30~70%RH**

**■ Packaging**

Reel Specifications & Packaging Quantity

Type	Packaging Quantity	Tape Width	Reel Diameter	ΦA (mm)	ΦB (mm)	ΦC (mm)	W (mm)	T (mm)	
CR-E5	Paper	20K	8mm	7 inch	178±2	58.0±2	13.0±0.5	9.5±1.0	12.5±1.5
CR-01	Paper	15K	8mm	7 inch	178±2	58.0±2	13.0±0.5	9.5±1.0	12.5±1.5
CR-02	Paper	10K	8mm	7 inch	178±2	58.0±2	13.0±0.5	9.5±1.0	12.5±1.5
CR-03 CR-05 CR-06 CR-10	Paper	5K	8mm	7 inch	178±2	58.0±2	13.0±0.5	9.5±1.0	12.5±1.5
CR-0A CR-12	Embossed	4K	12mm	7 inch	178±2	57.0±2	13.0±0.5	13.0±0.5	15.5±1.5

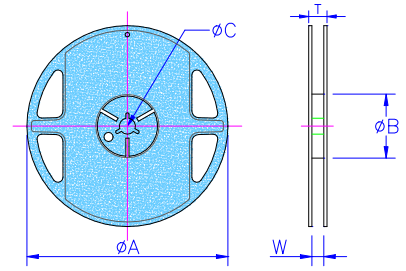

Paper Tape Specifications

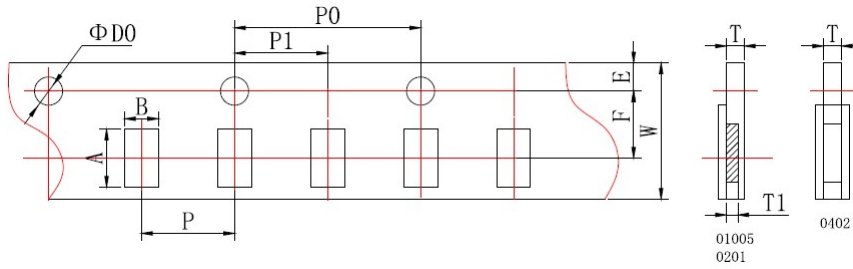

Type	A (mm)	B (mm)	W (mm)	E (mm)	F (mm)	P (mm)	P <sub>0</sub> (mm)	P <sub>1</sub> (mm)	ΦD <sub>0</sub> (mm)	T (mm)	T <sub>1</sub> (mm)
CR-E5	0.45±0.02	0.25±0.02	8.0±0.02	1.75±0.05	3.50±0.05	2.00±0.05	4.00±0.10	2.00±0.05	1.55±0.02	0.31±0.20	0.17±0.02
CR-01	0.70±0.10	0.40±0.10	8.0±0.20	1.75±0.10	3.50±0.05	2.00±0.05	4.00±0.10	2.00±0.05	1.55±0.10	0.42±0.05	0.28±0.05
CR-02	1.20±0.10	0.70±0.10	8.0±0.20	1.75±0.10	3.50±0.05	2.00±0.05	4.00±0.10	2.00±0.05	1.55±0.10	0.42±0.05	-

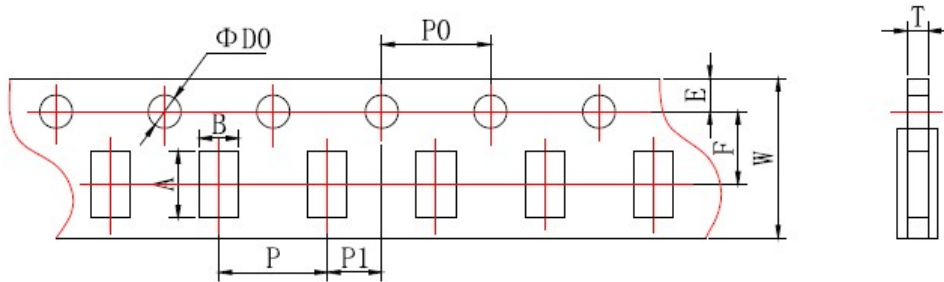

Type	A (mm)	B (mm)	W (mm)	E (mm)	F (mm)	P (mm)	P <sub>0</sub> (mm)	P <sub>1</sub> (mm)	ΦD <sub>0</sub> (mm)	T (mm)
CR-03	1.85±0.10	1.10±0.10	8.0±0.20	1.75±0.10	3.50±0.05	4.00±0.10	4.00±0.10	2.00±0.05	1.50±0.10	0.60±0.10
CR-05	2.35±0.10	1.65±0.10	8.0±0.20	1.75±0.10	3.50±0.05	4.00±0.10	4.00±0.10	2.00±0.05	1.50±0.10	0.75±0.10
CR-06	3.50±0.20	1.90±0.20	8.0±0.20	1.75±0.10	3.50±0.05	4.00±0.10	4.00±0.10	2.00±0.05	1.50±0.10	0.75±0.10
CR-10	3.50±0.20	2.80±0.20	8.0±0.20	1.75±0.10	3.50±0.05	4.00±0.10	4.00±0.10	2.00±0.05	1.50±0.10	0.75±0.10

**Thick Film Chip Resistor**

Embossed Plastic Tape Specifications

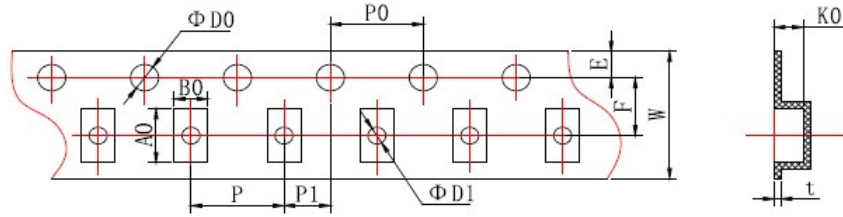

Type	A0 (mm)	B0 (mm)	W (mm)	E (mm)	F (mm)	P (mm)	P <sub>0</sub> (mm)	P <sub>1</sub> (mm)	ΦD <sub>0</sub> (mm)	ΦD <sub>1</sub> (mm)	K0 (mm)	t (mm)
CR-0A	5.50±0.15	2.82±0.15	12.0±0.10	1.75±0.10	5.5±0.10	4.00±0.10	4.00±0.10	2.00±0.05	1.50±0.1	1.50±0.10	0.84±0.10	0.25±0.05
CR-12	6.78±0.15	3.45±0.15	12.0±0.10	1.75±0.10	5.5±0.10	4.00±0.10	4.00±0.10	2.00±0.05	1.50±0.1	1.50±0.10	0.81±0.10	0.25±0.05

**■ Marking**

No Marking for 01005, 0201 and 0402

Jumper for all: Letter "0"

0603, 0805, 1206, 2512 for Example:

1210, 2010 for Example:

1% for 0805/1206/1210/2010/2512: 4 digits marking

Example:

Resistance	100Ω	2.2KΩ	10KΩ	49.9KΩ	100KΩ
Marking	1000	2201	1002	4992	1003

5% for 0603/0805/1206/1210/2010/2512: 3 digits marking in E24

Example: 101=100Ω 102=1KΩ (1<sup>st</sup> and 2<sup>nd</sup> are E24 code and 3<sup>rd</sup> code is multiplier)

E24 code	10	11	12	13	15	16	18	20	22	24	27	30	33	36	39	43	47	51	56	62	68	75	82	91
----------	----	----	----	----	----	----	----	----	----	----	----	----	----	----	----	----	----	----	----	----	----	----	----	----

1% for 0603(E24): 3 digits marking in E24

Example: one short bar under marking letter

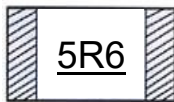

1% for 0603(E96): 3 digits marking in E96

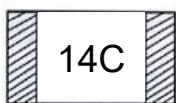

3 digits marking for Example: 14C=13K7Ω 13C=13K3Ω  
68B=4K99Ω 68X=49.9Ω

The decimal point should be expressed by "R"



**Marking Table**

Code	E96	Code	E96	Code	E96	Code	E96				
01	100	25	178	49	316	73	562				
02	102	26	182	50	324	74	576				
03	105	27	187	51	332	75	590				
04	107	28	191	52	340	76	604				
05	110	29	196	53	348	77	619				
06	113	30	200	54	357	78	634				
07	115	31	205	55	365	79	649				
08	118	32	210	56	374	80	665				
09	121	33	215	57	383	81	681				
10	124	34	221	58	392	82	698				
11	127	35	226	59	402	83	715				
12	130	36	232	60	412	84	732				
13	133	37	237	61	422	85	750				
14	137	38	243	62	432	86	768				
15	140	39	249	63	442	87	787				
16	143	40	255	64	453	88	806				
17	147	41	261	65	464	89	825				
18	150	42	267	66	475	90	845				
19	154	43	274	67	487	91	866				
20	158	44	280	68	499	92	887				
21	162	45	287	69	511	93	909				
22	165	46	294	70	523	94	931				
23	169	47	301	71	536	95	953				
24	174	48	309	72	549	96	976				
Code	A	B	C	D	E	F	G	X	Y		
Multiplier	10 <sup>0</sup>	10 <sup>1</sup>	10 <sup>2</sup>	10 <sup>3</sup>	10 <sup>4</sup>	10 <sup>5</sup>	10 <sup>6</sup>	10 <sup>-1</sup>	10 <sup>-2</sup>		