

Data Sheet

Customer :

Product : Thin Film Array Chip Resistor - TFAN Series

Size: 0603x4

Issued Date: 17-Feb-22

Edition : REV.B8



VIKING TECH CORPORATION
光頡科技股份有限公司

No.70, Guangfu N. Rad.,
Hsin Chu Industrial Park,
Hukou Hsiang, Hsin Chu Hsien,
303, Taiwan

TEL:886-3-5972931

FAX:886-3-5972935•886-3-5973494

E-mail:sales@viking.com.tw

VIKING TECH CORPORATION KAOHSIUNG BRANCH
光頡科技股份有限公司高雄分公司

No.248-3, Sin-Sheng Rd., Cian-Jhen Dist., Kaohsiung,
806, Taiwan

TEL:886-7-8217999

FAX:886-7-8228229

E-mail:sales@viking.com.tw

Viking Electronics (WUXI) CO., LTD.
光頡電子(無錫)有限公司

No.1A,(Xixia Road),Machinery & Industry Park,
National Hi-Tech Industrial Development Zone of
Wuxi, Wuxi, Jiangsu Province, China

Zip Code:214028

TEL:86-510-85203339

FAX:86-510-85203667•86-510-85203977

E-mail:wuxisales@tmtec.com.tw

| Produced by (QC) | Checked (QC) | Approved by (QC) | Prepared by (Sales) | Accepted by (Customer) |
|---------------------|------------------|---------------------|------------------------|---------------------------|
| 17-Feb-22 | 17-Feb-22 | 17-Feb-22 | 17-Feb-22 | |
| <i>Chun</i> | <i>Ben Chang</i> | <i>Ben Chang</i> | | |

Thin Film Array Chip Resistor (TFAN Series)

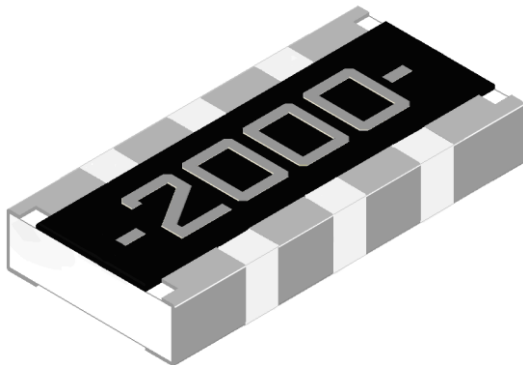

■ Features

- Advanced thin film technology
- Very tight tolerance down to $\pm 0.05\%$
- Extremely low TCR down to $\pm 5\text{PPM}/^\circ\text{C}$
- TCR tracking down to 5ppm($\pm 2.5\text{ppm}$) and tolerance matching down to 0.1%($\pm 0.05\%$)
- RoHS compliant component, compatible with lead (Pb)-free

■ Applications

- Voltage divider
- Feedback circuits
- Signal conditioning

■ Construction

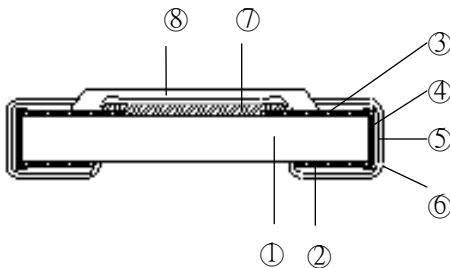

| | | |
|---------------------|----------------------|------------------|
| ① Alumina Substrate | ④ Edge Electrode | ⑦ Resistor Layer |
| ② Bottom Electrode | ⑤ Barrier Layer | ⑧ Overcoat |
| ③ Top Electrode | ⑥ External Electrode | |

■ Equivalent Circuit Diagram

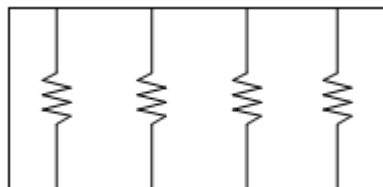

TFAN43

■ Dimensions

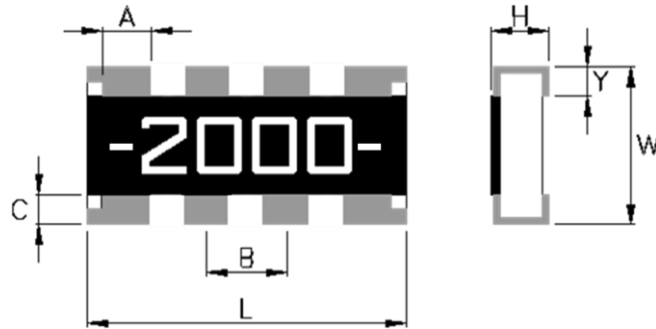

| Type | Number of Resistors | L | W | H | A | B | C | Y |
|--------|---------------------|-----------|-----------|-----------|-----------|-----------|-----------|-----------|
| TFAN43 | 4 | 3.20±0.15 | 1.60±0.15 | 0.55±0.10 | 0.50±0.15 | 0.80±0.05 | 0.25±0.15 | 0.30±0.15 |

■ Part Numbering

| TFAN | 43 | B0 | T | C0 | Y | 1001 | N |
|--------------|------------|---------------------------------|---------------------------|---------------------------|----------------------|--|---|
| Product Type | Dimensions | Tolerance Grade | Packaging Code | TCR Grade | Power Rating | Resistance | Marking Code |
| | 0603X4 | Reference Tolerance Grade Table | T: Taping Reel B: Bulk | Reference TCR Grade Table | Y: 1/16W X: 1/10W | 1000: 100Ω 1001: 1KΩ 1211: 1.21KΩ 3323: 332KΩ | : Standard Marking for E96 N: No Marking |

| Tolerance Grade | | | | TCR Grade | | | |
|-----------------|--------------------|--------------------|------------------|-----------|--------------|--------------|------------------|
| Code | Absolute Tolerance | Tolerance Matching | Resistance Value | Code | Absolute TCR | TCR Tracking | Resistance Value |
| A0 | ±0.05% | N/A | 24.9~332K | S0 | ±5ppm | N/A | 24.9~60K |
| B0 | ±0.1% | N/A | 24.9~332K | S5 | ±5ppm | 5ppm | 24.9~60K |
| B3 | ±0.1% | 0.1% | 24.9~332K | B0 | ±10ppm | N/A | 24.9 ~332K |
| C0 | ±0.25% | N/A | 24.9~332K | B4 | ±10ppm | 10ppm | 24.9 ~332K |
| C2 | ±0.25% | 0.25% | 24.9~332K | B5 | ±10ppm | 5ppm | 24.9~60K |
| C3 | ±0.25% | 0.1% | 24.9~332K | N0 | ±15ppm | N/A | 24.9 ~332K |
| D0 | ±0.5% | N/A | 24.9~332K | N3 | ±15ppm | 15ppm | 24.9 ~332K |
| D1 | ±0.5% | 0.5% | 24.9~332K | N4 | ±15ppm | 10ppm | 24.9 ~332K |
| D2 | ±0.5% | 0.25% | 24.9~332K | N5 | ±15ppm | 5ppm | 24.9~60K |
| F0 | ±1% | N/A | 24.9~332K | C0 | ±25ppm | N/A | 24.9~332K |
| F1 | ±1% | 0.5% | 24.9~332K | C2 | ±25ppm | 25ppm | 24.9~332K |
| F2 | ±1% | 0.25% | 24.9~332K | C3 | ±25ppm | 15ppm | 24.9~332K |
| | | | | C4 | ±25ppm | 10ppm | 24.9~332K |
| | | | | D0 | ±50ppm | N/A | 24.9~332K |
| | | | | D1 | ±50ppm | 50ppm | 24.9~332K |
| | | | | D2 | ±50ppm | 25ppm | 24.9~332K |

Derating Curve

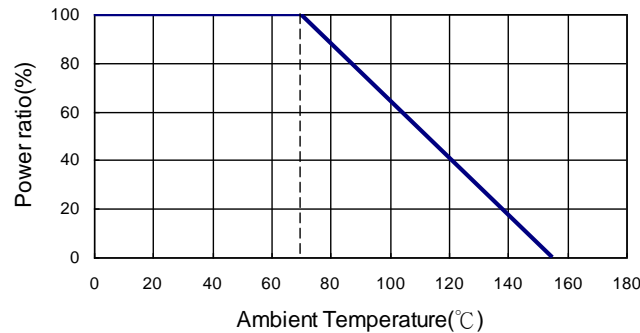

Electrical Specifications

| Item Type | Power Rating at 70°C | Operating Temp. Range | Max. Operating Voltage | Max. Overload Voltage | Resistance Range | | | | | TCR (PPM/°C) |
|-----------|----------------------|-----------------------|------------------------|-----------------------|------------------|-------|--------|-------|-----|--------------------------|
| | | | | | ±0.05% | ±0.1% | ±0.25% | ±0.5% | ±1% | |
| TFAN 43 | 1/16W | -55 ~ +155°C | 50V | 100V | 24.9Ω-332KΩ | | | | | ±10 ±15 ±25 ±50 |
| | 1/10W | -55 ~ +155°C | 75V | 150V | | | | | | |
| | 1/16W | -55 ~ +155°C | 50V | 100V | 24.9Ω-60KΩ | | | | | ±5 |
| | 1/10W | -55 ~ +155°C | 75V | 150V | | | | | | |

Operating Voltage= $\sqrt{P \cdot R}$ or Max. operating voltage listed above, whichever is lower.
 Overload Voltage= $2.5 \cdot \sqrt{P \cdot R}$ or Max. overload voltage listed above, whichever is lower.
 ■Viking is capable of manufacturing the optional spec based on customer's requirement.

Environmental Characteristics

| Item | Requirement | Test Method |
|--|---|---|
| Temperature Coefficient of Resistance (T.C.R.) | As Spec. | MIL-STD-202 Method 304 +25/-55/+25/+125/+25°C |
| Short Time Overload | $\Delta R \pm 0.1\%$ | JIS-C-5201-1 4.13 RCWV*2.5 or Max. overload voltage whichever is lower for 5 seconds |
| Insulation Resistance | >1000 MΩ | MIL-STD-202 Method 302 Apply 100V _{DC} for 1 minute |
| Endurance | 1000Hr : $\Delta R \pm 0.15\%$ 8000Hr : $\Delta R \pm 0.3\%$ | MIL-STD-202 Method 108 70±2°C, RCWV with 1.5 hrs "ON" and 0.5 hrs "OFF" |
| Damp Heat with Load | $\Delta R \pm 0.25\%$ | MIL-STD-202 Method 103 40±2°C, 90-95% R.H., RCWV for 1000 hrs with 1.5 hrs "ON" and 0.5 hrs "OFF" |
| Damp Heat with Load(85°C/85% R.H) | $\Delta R \pm 0.5\%$ | 85±2°C, 80-90% R.H. 10% of RCWV for 1000 hrs with 1.5 hrs "ON" and 0.5 hrs "OFF" |
| Dry Heat | 1000Hr : $\Delta R \pm 0.25\%$ 8000Hr : $\Delta R \pm 0.5\%$ | At +125°C |
| Bending Strength | $\Delta R \pm 0.2\%$ | JIS-C-5201-1 4.33 Bending amplitude 3 mm for 10 seconds |
| Solderability | 95% min. coverage | MIL-STD-202 Method 208 245±5°C for 3 seconds |

| | | |
|------------------------------|-----------------------|---|
| Resistance to Soldering Heat | $\Delta R \pm 0.2\%$ | MIL-STD-202 Method 210 260 \pm 5°C for 10 seconds |
| Dielectric Withstand Voltage | 100V | MIL-STD-202 Method 301 Max. overload voltage for 1 minute |
| Thermal Shock | $\Delta R \pm 0.25\%$ | MIL-STD-202 Method 107 -55°C ~150°C, 100 cycles |
| Low Temperature Operation | $\Delta R \pm 0.25\%$ | JIS-C-5201-1 4.36 1 hour, -65°C, followed by 45 minutes of RCWV |

RCWV(Rated continuous working voltage)= $\sqrt{P \cdot R}$ or Max. Operating voltage whichever is lower

- Storage Temperature: 15~28°C; Humidity < 80%RH
- Shelf Life: 2 years from production date.

■ Soldering Condition(IPC/JEDEC J-STD-020)

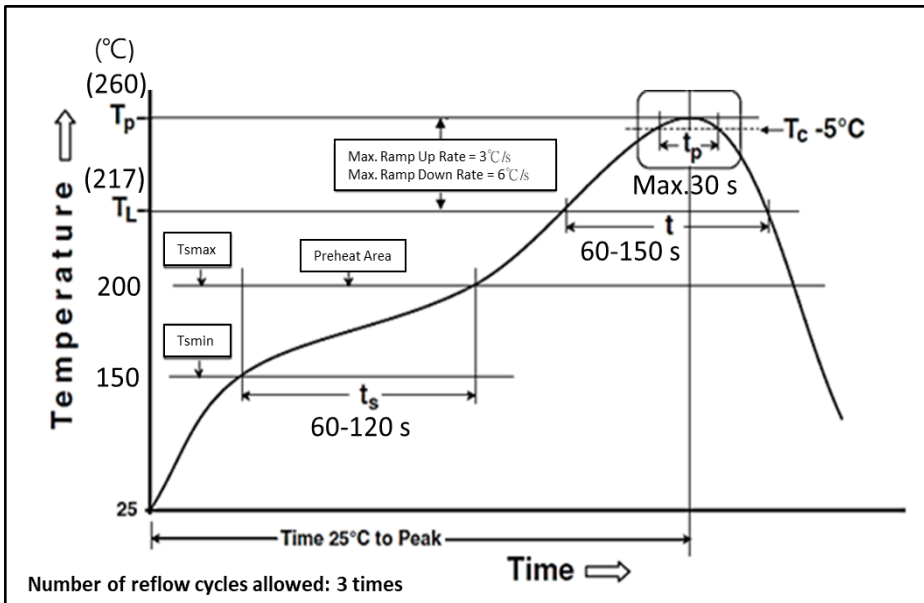

■ Packaging

Reel Specifications & Packaging Quantity

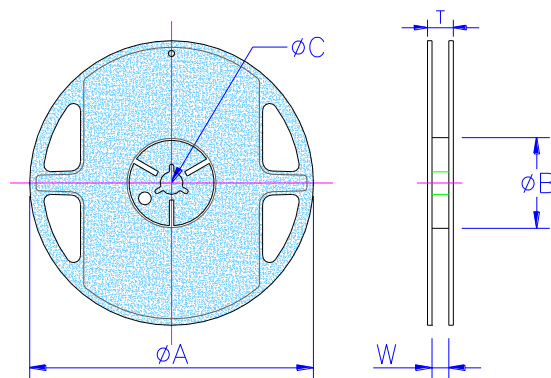

Unit: mm

| Type | Packaging Quantity | | Tape width | Reel Diameter | ΦA | ΦB | ΦC | W | T |
|---------|--------------------|----|------------|---------------|-----------|---------------------|----------|---------|----------|
| TFAN 43 | Paper | 5K | 8mm | 7 inch | 178.5±1.5 | 60 ^{+1/-0} | 13.0±0.2 | 9.0±0.5 | 12.5±0.5 |

Paper Tape Specifications

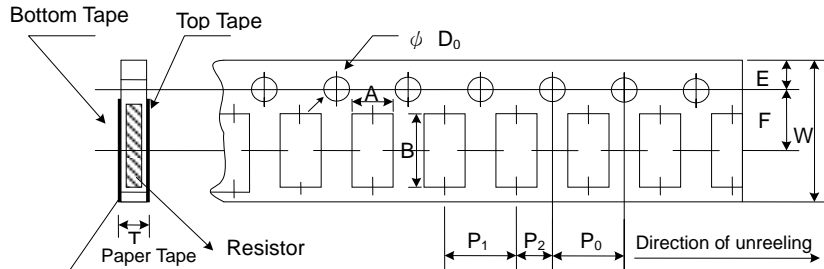

Unit: mm

| Type | A | B | W | E | F | P ₀ | P ₁ | P ₂ | ΦD ₀ | T |
|--------|----------|----------|---------|----------|----------|----------------|----------------|----------------|------------------------|----------|
| TFAN43 | 1.95±0.1 | 3.50±0.1 | 8.0±0.2 | 1.75±0.1 | 3.5±0.05 | 4.0±0.1 | 4.0±0.05 | 2.0±0.05 | 1.5 ^{+0.1/-0} | 0.85±0.1 |

■ Marking

TFAN 43: 4 digits marking

Example:

| Resistance | 100Ω | 2.2KΩ | 10KΩ | 49.9KΩ | 100KΩ | 332KΩ |
|------------|------|-------|------|--------|-------|-------|
| marking | 1000 | 2201 | 1002 | 4992 | 1003 | 3323 |

■ Recommend Land Pattern

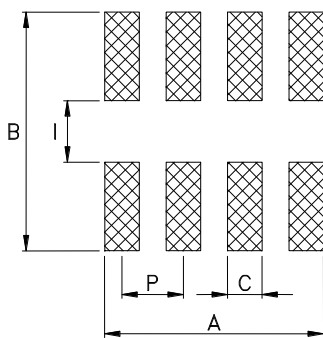

Unit: mm

| Type | A | B | C | I | P |
|--------|------|------|------|------|------|
| TFAN43 | 3.10 | 2.85 | 0.45 | 0.80 | 0.80 |